

TRAFFIC IMPACT STUDY

OCEAN BREEZE RANCH
SAN DIEGO COUNTY, CALIFORNIA

This Traffic Impact Study has been prepared under the supervision of
Ambarish Mukherjee, P.E.



LSA

September 2019

TRAFFIC IMPACT STUDY

OCEAN BREEZE RANCH SAN DIEGO COUNTY, CALIFORNIA

Submitted to:

Ocean Breeze Ranch, LLC
5820 Lilac Road
Bonsall, California 92003

Prepared by:

LSA
20 Executive Park, Suite 200
Irvine, California 92614
(949) 553-0666

Project No. JCO1501



September 2019

EXECUTIVE SUMMARY

The purpose of this Traffic Impact Study (TIS) is to identify and disclose any potential circulation impacts associated with the Ocean Breeze Ranch Project (project) development on local area roadways and intersections. The project site is located in Bonsall, CA, an unincorporated community of San Diego County (located in Traffic Analysis Zone [TAZ] 165) consists primarily of single-family residential, one middle school, orchards, agriculture, and inactive use. The project includes the construction of 396 dwelling units (DUs). The project is proposed to take access via two public streets connecting to West Lilac Road with a third access point through the existing western terminus of Dulin Road northeast of the site. The existing on-site equestrian center will be preserved for the private use of its owners and, therefore, is not anticipated to generate external vehicular trips.

This study focuses on the daily a.m. peak-hour and p.m. peak-hour levels of service (LOS) at 20 intersections, 18 roadway segments, and 4 State Route 76 (SR-76) and 2 Interstate 15 (I-15) mainline segments. Project impacts were determined based on analysis of the following conditions:

- Existing
- Existing Plus Project
- Existing Plus Cumulative Projects Plus Project

In an effort to review the project's consistency with the County of San Diego (County) General Plan Land Use Element and Mobility Element at build out of the Land Use Element, a General Plan consistency analysis was conducted and is included in this TIS. The project is consistent with the General Plan Land Use Element, and therefore the project is included in the latest General Plan Update traffic volume forecasts. Therefore, the circulation needs of the General Plan Build-Out to support regional as well as project-specific demand have been incorporated into policies, programs, and capital planning. The General Plan consistency analysis provides a cursory review of the already adopted General Plan growth estimates and daily traffic volume-to-capacity (v/c) ratios. The General Plan roadway network is anticipated to adequately service the study area at build out of the Land Use Element.

The proposed project is anticipated to generate 3,990 average daily trips (ADT), 320 a.m. peak-hour trips (97 inbound and 223 outbound), and 399 p.m. peak-hour trips (280 inbound and 119 outbound).

Based on the results of this TIS, the project would cause direct project impacts to the following intersections in the Existing Plus Project condition:

- West Lilac Road/Camino Del Rey
- Old Highway 395/West Lilac Road

The intersection of West Lilac Road/Camino Del Rey was analyzed under three mitigation alternatives: roundabout control, signalization, and all-way stop control with eastbound left-turn lane. Under mitigation alternative three, the addition of project traffic to existing eastbound left-

turns at the intersection of West Lilac Road/ Camino Del Rey will exceed County policy on the number of left turns at a through lane. Based on the County's *Public Road Standards* (County of San Diego 2012) and input from County staff, a left-turn lane is recommended when the left-turning traffic volume is estimated to exceed 300 vehicles during the peak hour. Under this alternative, it is recommended that the project construct this left-turn lane due to the finding that the addition of project traffic will cause the intersection to exceed this threshold. Specifically, this guidance is met through the project's addition of 30 trips to the existing 300 eastbound left-turns in the a.m. peak hour. This improvement is recommended per County policy for this alternative.

All three mitigation alternatives are viable options for operational improvements at West Lilac Road/Camino Del Rey; however, not all mitigation alternatives may be acceptable by various County departments based on County guidelines and policies. Through extensive coordination and input from County staff, roundabout control was ultimately identified as the preferred alternative at this intersection.

The project would cause cumulative impacts to the following intersections in the Existing Plus Cumulative Projects Plus Project condition:

- SR-76/Olive Hill Road-Camino Del Rey
- West Lilac Road/Camino Del Rey
- Old Highway 395/SR-76
- Old Highway 395/West Lilac Road
- I-15 southbound ramps/Old Highway 395
- I-15 northbound ramps/Old Highway 395
- Old Highway 395/Camino Del Rey
- Old Highway 395/Gopher Canyon Road
- Lilac Road/Old Castle Road
- SR-76/Old River Road—East Vista Way
- SR-76/North River Road
- SR-76/Via Montellano

The project access point locations were assessed for their operational adequacy. Based on the results of a queuing analysis in the Existing Plus Project and the Existing Plus Cumulative Projects Plus Project conditions at the two access points along West Lilac Road, the maximum outbound queue at both project intersections (Road A1/West Lilac Road and Road A3/West Lilac Road) is approximately four vehicles. As stated in the County's *Public Road Standards, Page 14, Section 4.4, C.5*, a left-turn lane is recommended for a Light Collector roadway segment when there are 50 or more peak-hour vehicles making a left turn (53 eastbound left turns are anticipated at each of the two access points). County standards require a minimum left-turn storage length of 200 feet (ft) with a 120 ft taper at both intersections of Road A1 and Road A3 with West Lilac Road.

Internal daily roadway capacities were analyzed to determine whether the internal roadways could satisfactorily accommodate future residents. The internal roadways are anticipated to satisfactorily accommodate the project's potential daily traffic demand.

The project incorporates design features to accommodate pedestrian circulation on site. The project will construct sidewalks on all connectors to existing or planned pedestrian facilities on adjacent roadways. Due to the rural nature of the study area, the presence of sidewalks is infrequent along roadways outside of the project and sidewalks exist exclusively along the roadway frontage of some residential developments. A continuous pedestrian mobility network linking the fully constructed project to other roads in the area does not exist at this time.

Class II bike lanes currently exist on both sides of Old Highway 395 through the length of the study area, from Fallbrook in the north to Escondido in the south. Future bike facilities as shown in the General Plan Mobility Element include the following:

- Class I bike path
 - SR-76 for the length of the Bonsall Preserve
- Class II bike lanes
 - SR-76 from Oceanside to Fallbrook
 - Old Highway 395 from Fallbrook to Hidden Meadows
 - West Lilac Road from Camino Del Rey to Old Highway 395
 - Camino Del Rey from Old River Road to Old Highway 395

Although existing transit services are limited, the Bonsall area is served by the North County Transit District (NCTD). A stop for Route 306 (Community of Fallbrook to Vista Via Mission Road) is located along SR-76 at Camino Del Rey and a Park and Ride for Route 388/389 (Escondido to Pala) is located on the northeast corner of Old Highway 395/SR-76.

TABLE OF CONTENTS

Executive Summary	i
Figures and Tables	vi
List of Abbreviations and Acronyms	viii
INTRODUCTION	1
PROJECT LOCATION AND DESCRIPTION	1
Study Conditions	4
METHODOLOGY	5
Peak-Hour Intersection Analysis Methodology	5
Roadway/Two-Lane Highway Segment Analysis Methodology	6
Freeway Segment Analysis Methodology	9
Ramp Intersection Capacity Analysis Methodology	10
San Diego Traffic Engineers' Council/Institute of Traffic Engineers Guidelines	10
EXISTING TRANSPORTATION CONDITIONS	10
Existing Roadway Network	11
Existing Volumes	15
Existing Level of Service Analysis	15
PROJECT TRAFFIC	20
Project Description	20
Project Phasing	20
Project Trip Generation, Distribution, and Assignment	20
EXISTING PLUS PROJECT CONDITIONS	21
Existing Plus Project Roadway Network and Traffic Volumes	21
Existing Plus Project Study Area Intersection Level of Service Analysis	21
Existing Plus Project Study Area Intersection Roadway/Two-Lane Highway Segment Level of Service Analysis	21
Existing Plus Project Freeway Segment Level of Service Analysis	27
Existing Plus Project Ramp Intersection Capacity Analysis	27
CUMULATIVE TRAFFIC CONDITIONS	27
Cumulative Volumes	27
Existing Plus Cumulative Projects Plus Project Conditions	31
Existing Plus Cumulative Projects Plus Project Roadway Network and Traffic Volumes	31
Existing Plus Cumulative Projects Plus Project Study Area Intersection Level of Service Analysis	31
Existing Plus Cumulative Projects Plus Project Study Area Intersection Roadway/Two- Lane Highway Segment Level of Service Analysis	33
Existing Plus Cumulative Projects Plus Project Freeway Segment Level of Service Analysis	33
Existing Plus Cumulative Projects Plus Project Ramp Intersection Capacity Analysis	33

SITE ACCESS AND ON-SITE CIRCULATION	33
Site Access	33
Internal Roadway Circulation	38
Internal Pedestrian Facility Network.....	40
GENERAL PLAN CONSISTENCY ANALYSIS	40
SIGNAL WARRANT ANALYSIS	42
EXISTING PLUS PROJECT IMPACTS AND IMPROVEMENTS	44
Intersections.....	44
Roadway Segments	48
Two-Lane Highways.....	48
EXISTING PLUS CUMULATIVE PROJECTS PLUS PROJECT IMPACTS AND IMPROVEMENTS.....	48
Intersections.....	48
Fair Share Contribution to SR-76 Corridor Improvements.....	49
Fee Programs.....	50
Roadway Segments	51
SUMMARY OF RECOMMENDED IMPROVEMENTS AND PROJECT DESIGN FEATURES.....	52
REFERENCES	54

APPENDICES

- A: COUNT DATA, 2017 CALTRANS TRAFFIC VOLUMES AND 2016 TRUCK VOLUMES
- B: HCM INTERSECTION LOS WORKSHEETS
- C: SELECT ZONE TRAFFIC MODEL PLOT
- D: CUMULATIVE PROJECTS LIST AND MAP
- E: SITE ACCESS HCM INTERSECTION LOS AND QUEUING WORKSHEETS
- F: GENERAL PLAN (2030) TRAFFIC MODEL FORECAST PLOTS
- G: RECOMMENDED IMPROVEMENTS AND LOS WORKSHEETS
- H: SIGNAL WARRANT WORKSHEETS

FIGURES AND TABLES

FIGURES

Figure 1: Project Location and Study Area Intersections	2
Figure 2: Site Plan	3
Figure 3: Existing Intersection Geometrics.....	12
Figure 4: Existing Peak-Hour Volumes (AM/PM).....	16
Figure 5: Project Trip Distribution	22
Figure 6: Project Peak-Hour Volumes (AM/PM)	23
Figure 7: Existing Plus Project Peak-Hour Volumes (AM/PM).....	24
Figure 8: Cumulative Projects Peak-Hour Volumes (AM/PM).....	29
Figure 9: Existing Plus Cumulative Projects Plus Project Peak-Hour Volumes (AM/PM).....	30
Figure 10: Internal Roadway Average Daily Traffic (ADT)	39
Figure 11: Pedestrian Circulation	41

TABLES

Table A: Measures of Significant Project Impacts to Congestion on Intersections: Allowable Increases on Congested Intersections.....	6
Table B: Measures of Significant Project Impacts to Congestion on Circulation Element Road Segments: Allowable Increases on Congested Road Segments.....	8
Table C: Measures of Significant Project Impacts to Congestion – Allowable Increases on Two-Lane Highways with Signalized Intersection Spacing Over 1 Mile	8
Table D: Measures of Significant Project Impacts to Congestion – Allowable Increases on Two-Lane Highways with Signalized Intersection Spacing Less Than 1 Mile	9
Table E: San Diego Traffic Engineers’ Council/Institute of Transportation Engineers Measure of Significant Project Traffic Impacts.....	10
Table F: Existing Intersection LOS Summary	17
Table G: Existing Average Daily Traffic Volumes and Levels of Service.....	18
Table H: Existing Freeway Segment Level of Service Analysis.....	19
Table I: Existing Ramp Intersection Capacity Analysis.....	19
Table J: Project Trip Generation Summary.....	20
Table K: Existing Plus Project Intersection Level of Service Summary	25
Table L: Existing Plus Project Average Daily Traffic Volumes and Levels of Service	26
Table M: Existing Plus Project Freeway Segment Level of Service Analysis.....	28
Table N: Existing Plus Project Ramp Intersection Capacity Analysis	28
Table O: Existing Plus Cumulative Projects Plus Project Intersection Level of Service Summary	32
Table P: Existing Plus Cumulative Projects Plus Project Average Daily Traffic Volumes and Levels of Service	34
Table Q: Existing Plus Cumulative Projects Plus Project Freeway Segment Level of Service Analysis.....	35
Table R: Existing Plus Cumulative Projects Plus Project Ramp Intersection Capacity Analysis.....	36

Table S: Project Intersection Level of Service Summary	36
Table T: Project Access Intersection Level of Service Summary	37
Table U: Project Intersection Queuing Summary	38
Table V: Internal Roadway Average Daily Traffic Volumes and Volume-to-Capacity Ratios	40
Table W: General Plan (2030) Average Daily Traffic Volumes and Levels of Service	43
Table X: Existing Plus Project Intersection Significant Impact Mitigation	47
Table Y: Unsignalized Intersection Cumulative Impact Mitigation Summary	50

LIST OF ABBREVIATIONS AND ACRONYMS

ADT	average daily trips
Caltrans	California Department of Transportation
CEQA	California Environmental Quality Act
CIP	Capital Improvement Project
County	County of San Diego
County Guidelines	<i>Guidelines for Determining Significance and Report Format and Content Requirements Transportation and Traffic</i>
CPA	Community Planned Area
DU	dwelling unit
ft	foot/feet
HCM 2010	<i>Highway Capacity Manual 2010</i>
HDM	<i>Highway Design Manual</i>
I-15	Interstate 15
ILV	intersecting lane volume
LOS	level of service
mi	mile/miles
mph	miles per hour
MUTCD	Manual of Uniform Traffic Control Devices (California)
NCHRP	National Cooperative Highway Research Program
NCTD	North County Transit District
pc/h/ln	passenger cars per hour per lane
project	Ocean Breeze Ranch Project
RTCIP	Regional Transportation Congestion Improvement Program
RTP	Regional Transportation Plan
SANDAG	San Diego Association of Governments
SANTEC/ITE	San Diego Traffic Engineers' Council/Institute of Transportation Engineers
SANTEC/ITE Guidelines	<i>San Diego Traffic Engineers' Council/Institute of Transportation Engineers Guidelines for Traffic Impact Studies in the San Diego Region</i>
SCS	Sustainable Communities Strategy
SR-76	State Route 76

TAZ	Traffic Analysis Zone
TIF	Transportation Impact Fee
TIF Nexus Study	<i>County of San Diego Transportation Impact Fee Program Update Nexus Study</i>
TIS	Traffic Impact Study
v/c	volume-to-capacity

TRAFFIC IMPACT STUDY OCEAN BREEZE RANCH

INTRODUCTION

LSA has prepared the following Traffic Impact Study (TIS) to identify potential short-term traffic impacts and consistency with the long-range General Plan Land Use Element and Mobility Element associated with the development of 396 dwelling units (DUs) for the Ocean Breeze Ranch Project (project), located in the unincorporated area of Bonsall in San Diego County. LSA has prepared this TIS consistent with an approved Scope of Work dated November 2, 2017, coordination with County of San Diego (County) transportation staff, and traffic forecasts from the San Diego Association of Governments (SANDAG) Series 12 traffic model. This TIS has been conducted in a format consistent with the requirements of the San Diego Traffic Engineers' Council/Institute of Transportation Engineers (SANTEC/ITE) *Guidelines for Traffic Impact Studies in the San Diego Region* (SANTEC/ITE Guidelines), the County *Traffic Impact Study Guidelines*, the SANDAG 2050 Regional Transportation Plan (RTP) and Sustainable Communities Strategy (SCS), and applicable provisions of the California Environmental Quality Act (CEQA).

PROJECT LOCATION AND DESCRIPTION

The project site is in the unincorporated area of Bonsall in San Diego County, bounded by the San Luis Rey River to the north, West Lilac Road to the south and to the west, and Dulin Road to the east, as shown on Figure 1.

The proposed project includes the development of 396 single-family DUs. The proposed project is consistent with the build out of the County General Plan Land Use Element and is reflected in all future traffic forecasts. The project proposes to take access via new public roads connecting at two locations with West Lilac Road with a third access point through the existing western terminus of Dulin Road northeast of the site. The existing on-site equestrian center will be preserved for the private use of its owners and, therefore, is not anticipated to generate external vehicular trips. Figure 2 shows a site plan of the project.

As illustrated on Figure 1, the study area includes the following intersections:

1. State Route 76 (SR-76)/Olive Hill Road-Camino Del Rey
2. Old River Road/Camino Del Rey
3. West Lilac Road/Camino Del Rey
4. Old Highway 395/SR-76
5. Old Highway 395/Dulin Road
6. Old Highway 395/West Lilac Road
7. Interstate 15 (I-15) southbound ramps/Old Highway 395
8. I-15 northbound ramps/Old Highway 395
9. Old Highway 395/Camino Del Rey
10. Old Highway 395/Circle R Drive

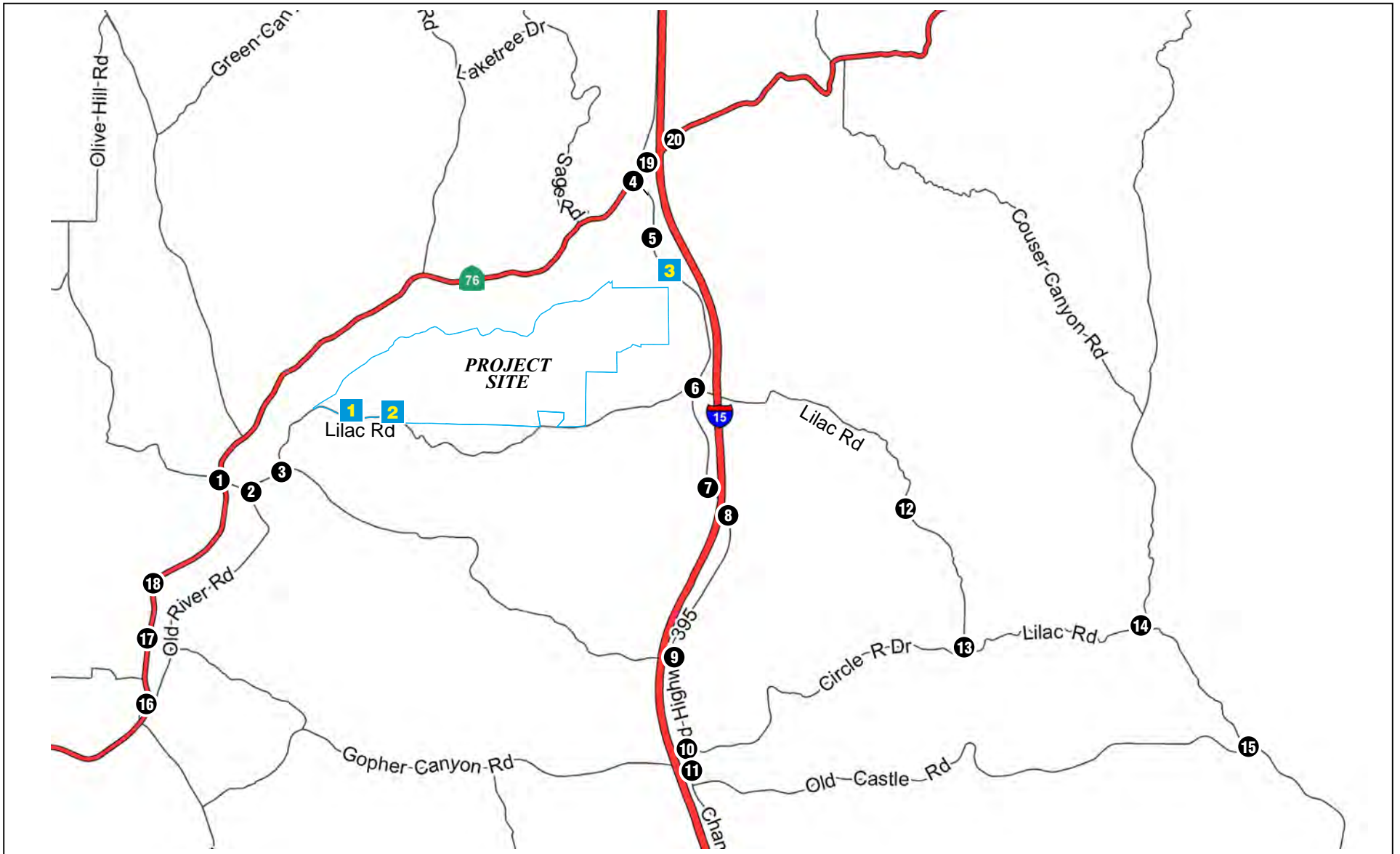

FIGURE 1

LSA

LEGEND

- # - Study Area Intersection
- # - Project Intersection



SOURCE: ESRI

I:\CO1501\G\Location&Study Ints.cdr (3/28/2019)

Ocean Breeze Ranch Traffic Impact Study
Project Location and Study Area Intersections

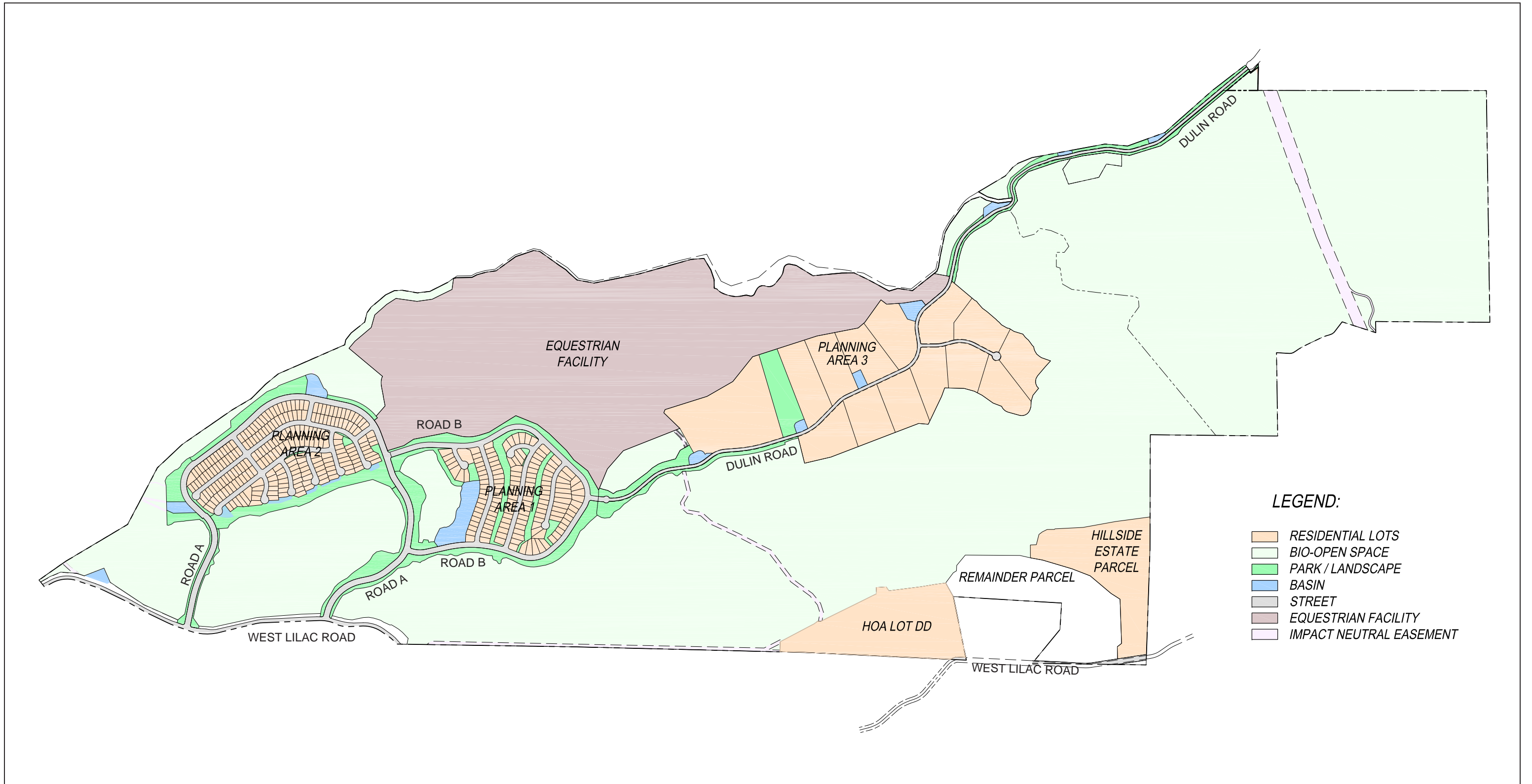

FIGURE 2

LSA



NOT TO SCALE

SOURCE: Project Design Consultants

I:\CO1501\G\Site Plan.cdr (5/10/2019)

11. Old Highway 395/Gopher Canyon Road
12. West Lilac Road/Covey Lane
13. West Lilac Road/Circle R Drive
14. Lilac Road/West Lilac Road
15. Lilac Road/Old Castle Road
16. SR-76/Old River Road–East Vista Way
17. SR-76/North River Road
18. SR-76/Via Montellano
19. I-15 southbound ramps/SR-76
20. I-15 northbound ramps/SR-76

Roadway analysis was conducted at the following segments within the study area:

1. Dulin Road from Old Highway 395 to Lake Circle Drive
2. West Lilac Road from Camino Del Rey to Vessels Ranch Road
3. West Lilac Road from Rawhide Ranch Road to Bobritt Lane
4. West Lilac Road from Old Highway 395 to Ranchos Ladera Road
5. West Lilac Road from I-15 to Standel Lane
6. West Lilac Road from Circle R Drive to Lal Bagh Lane
7. West Lilac Road from Diaz Road to North Berry Road
8. Camino Del Rey from Old River Road to West Lilac Road
9. Lilac Road from West Lilac Road to Old Castle Road
10. Old Highway 395 from SR-76 to Dulin Road
11. Old Highway 395 from Dulin Road (north) to Dulin Road (south)
12. Old Highway 395 from West Lilac Road to Via Urner Road
13. Old Highway 395 from I-15 southbound ramps to I-15 northbound ramps
14. Old Highway 395 from Camino Del Rey to Nelson Way
15. Old Highway 395 from Circle R Drive to Camino Del Rey
16. Old Highway 395 from Circle R Drive to Gopher Canyon Road
17. Old River Road from Golf Club Drive to Dentro De Lomas Road
18. Camino Del Rey west of Via Maria Elena

Study Conditions

This TIS focuses on the analysis of peak-hour intersection operations, daily roadway and two-lane highway segment level of service (LOS), peak-hour freeway mainline segment LOS, and highway ramp intersection capacity for the following conditions:

1. Existing
2. Existing Plus Project
3. Existing Plus Cumulative Projects Plus Project

In an effort to review the project's consistency with the General Plan Land Use Element and Mobility Element at build out of the Land Use Element, a General Plan consistency analysis was conducted. Because the project is consistent with the General Plan Land Use Element, the project is included in

the latest General Plan Update traffic volume forecasts. The General Plan consistency analysis will consist of a daily traffic volume capacity analysis.

METHODOLOGY

The TIS has been conducted in a format consistent with the requirements of the SANTEC/ITE Guidelines, the County *Traffic Impact Study Guidelines*, the SANDAG 2050 RTP/SCS, and applicable CEQA provisions. The study area was developed based on anticipated project trip distribution patterns and coordination with County staff.

This TIS utilized *Highway Capacity Manual 2010* (HCM 2010) methodology to assess peak-hour intersection operations, County-prescribed volume-to-capacity (v/c) methodologies for roadway and two-lane highway analysis, California Department of Transportation (Caltrans) District 11 performance criteria for freeway segment analysis, and Caltrans *Highway Design Manual* (HDM) Topic 406 procedures for ramp intersection capacity analysis. Thresholds of significance for identifying impacts are defined in the *Guidelines for Determining Significance and Report Format and Content Requirements Transportation and Traffic* (County Guidelines) (County of San Diego 2011) and the *Guide for the Preparation of Traffic Impact Studies* (Caltrans 2002). A summary of these analysis methodologies and thresholds is included below.

Peak-Hour Intersection Analysis Methodology

The peak-hour operations of signalized and unsignalized intersections were analyzed in accordance with Chapters 18, 19, and 20 of the HCM 2010 methodology. The performance measure for signalized and unsignalized all-way stop-controlled intersections is average seconds of delay per vehicle, while the performance measure for unsignalized one- or two-way stop-controlled intersections is the worst average delay per vehicle of any lane. Ranges of delay are assigned LOS grades of A through F, with A representing the lowest delays and F representing the highest delays. LOS D is considered the highest acceptable range of delays. The LOS criteria for signalized and unsignalized intersections are shown below.

Level of Service	Signalized Intersection Delay (seconds)	Unsignalized Intersection Delay (seconds)
A	≤10.0	≤10.0
B	>10.0 and ≤20.0	>10.0 and ≤15.0
C	>20.0 and ≤35.0	>15.0 and ≤25.0
D	>35.0 and ≤55.0	>25.0 and ≤35.0
E	>55.0 and ≤80.0	>35.0 and ≤50.0
F	>80.0	>50.0

Source: *Highway Capacity Manual* (Transportation Research Board 2010).

Peak-Hour Intersection Thresholds of Significance

Impacts are identified in this analysis in accordance with the County Guidelines. Impacts are based on a comparison of Existing, Existing Plus Project, and Existing Plus Cumulative Projects Plus Project analysis results.

Traffic volume increases that occur due to the project and result in one or more of the following criteria will have a significant traffic volume or LOS traffic impact on a signalized intersection:

- The addition or redistribution of vehicular trips generated by the project will significantly increase congestion on a signalized intersection currently operating at LOS E or LOS F, or will cause a signalized intersection to operate at LOS E or LOS F, as identified in Table A.

Table A: Measures of Significant Project Impacts to Congestion on Intersections: Allowable Increases on Congested Intersections

LOS	Signalized	Unsignalized
E	Delay of 2 seconds or less.	20 or fewer peak-hour trips on a critical movement.
F	Either a delay of 1 second, or 5 peak-hour trips or fewer on a critical movement.	5 or fewer peak-hour trips on a critical movement.

Source: Table 2, *Guidelines for Determining Significance and Report Format and Content Requirements Transportation and Traffic* (County of San Diego 2011).

Notes:

1. A critical movement is an intersection movement (right turn, left turn, through movement) that experiences excessive queues, which typically operate at LOS F.
 2. By adding proposed project trips to all other trips from a list of projects, these same tables are used to determine if total cumulative impacts are significant. If cumulative impacts are found to be significant, each project is responsible for mitigating its share of the cumulative impact.
 3. The County of San Diego may also determine impacts have occurred on roads even when a project's direct or cumulative impacts do not trigger an unacceptable LOS when such traffic uses a significant amount of remaining road capacity.
 4. For determining significance at signalized intersections with LOS F conditions, the analysis must evaluate both the delay and the number of trips on a critical movement. Exceedance of either criteria results in a significant impact.
- LOS = levels of service

- Based upon an evaluation of existing accident rates, the signal priority list, intersection geometrics, proximity of adjacent driveways, or other factors, the project would significantly impact the operations of the intersection.

Therefore, an impact is defined as an intersection that currently operates at an acceptable LOS (A, B, C, or D) and moves to an unacceptable LOS (E or F) with the addition of the project. Furthermore, the County provides clarification on added traffic as discussed in Table A.

Roadway/Two-Lane Highway Segment Analysis Methodology

County guidelines differentiate non-freeway roadway facilities as roadway segments, two-lane highway segments with spacing over 1 mile (mi), and two-lane highway segments with spacing less than 1 mi. Different analysis methodologies, segment capacities, and thresholds of significance are associated with each type of facility. LOS for roadway and two-lane highway facilities with signalized intersection spacing greater than 1 mi is based on daily segment volume versus maximum daily capacity, or v/c ratio. Grades of LOS A through F are assigned to ranges of v/c ratios, with LOS A being assigned to the lowest v/c ratios and LOS F being assigned to v/c ratios of over 1.0, representing daily segment volumes exceeding capacity. These measures are generally used as long-range planning guidelines because the actual capacity of a roadway segment is dependent on its physical attributes and the ability of arterial intersections to accommodate peak-hour volumes. The LOS criteria for roadway segments are shown below.

Class No.	Lanes	Design Speed	Roadway Classification	Level of Service (ADT)				
				A	B	C	D	E
6.1	6	65 mph	Expressway	36,000	54,000	70,000	86,000	108,000
6.2			Prime Arterial	22,200	37,000	44,600	50,000	57,000
4.1A	4	55 mph	Major Road with Raised Median	14,800	24,700	29,600	33,400	37,000
4.1B			Major Road with Intermittent Turn Lanes	13,700	22,800	27,400	30,800	34,200
4.2A	4	40 mph	Boulevard with Raised Median	5,700	12,500	19,000	27,000	32,500
4.2B			Boulevard with Intermittent Turn Lanes	5,000	10,900	17,200	25,000	30,000
2.1A	2	45 mph	Community Collector with Raised Median	2,800	6,500	10,300	15,000	20,500
2.1B			Community Collector with Continuous Turn Lane	3,000	6,000	9,500	13,500	19,000
2.1C			Community Collector with Intermittent Turn Lanes	3,000	6,000	9,500	13,500	19,000
2.1D			Community Collector with Improvement Options	3,000	6,000	9,500	13,500-15,000	19,000
2.1E			Community Collector	1,900	4,100	7,100	10,900	16,200
2.2A	2	40 mph	Light Collector with Raised Median	3,000	6,000	9,500	13,500	19,000
2.2B			Light Collector with Continuous Turn Lane	3,000	6,000	9,500	13,500	19,000
2.2C			Light Collector with Intermittent Turn Lanes	3,000	6,000	9,500	13,500	19,000
2.2D			Light Collector with Improvement Options	3,000	6,000	9,500	13,500	19,000
2.2E			Light Collector	1,900	4,100	7,100	10,900	16,200
2.2F			Light Collector with Reduced Shoulder	1,550	3,300	5,600	8,700	16,200
2.3A	2	35 mph	Minor Collector with Raised Median	1,400	3,000	5,100	8,000	12,900
2.3B			Minor Collector with Intermittent Turn Lanes	1,400	3,000	5,100	8,000	12,900
2.3C			Minor Collector	1,350	2,700	4,500	7,000	11,300

Source: County of San Diego General Plan Update Environmental Impact Report (County of San Diego 2011; Table 2.15-19).

ADT = average daily trips

mph = miles per hour

The LOS criteria for two-lane highway segments with signalized intersection spacing over 1 mi are shown below:

LOS	LOS Criteria
E	> 16,200 ADT
F	> 22,900 ADT

Source: Guidelines for Determining Significance and Report Format and Content Requirements Transportation and Traffic (County of San Diego 2011).

Note: Where detailed data are available, the Director of Public Works may also accept a detailed LOS analysis based upon the two-lane highway analysis procedures provided in Chapter 20 of the Highway Capacity Manual 2010.

ADT = average daily trips

LOS = level of service

LOS for two-lane highway segments with intersection spacing of less than 1 mi will be determined to be that of the intersections along the highway segment.

Roadway Segment Thresholds of Significance

As defined in the County Guidelines, measures of significant project impacts to roadway segments are based on allowable increases in daily project and cumulative project traffic on segments operating at unacceptable LOS (i.e., LOS E or F). The specific thresholds of increase vary depending on the type of roadway and the anticipated future LOS.

Traffic volume increases that occur due to the project and result in one or more of the following criteria will have a significant traffic volume or LOS traffic impact on a road segment:

- The additional or redistributed vehicular trips generated by the project will significantly increase congestion on a Circulation Element Road or State Highway currently operating at LOS E or LOS F as a result of the project as identified in Table B, or will cause a Circulation Element Road or State Highway to operate at LOS E or LOS F.

Table B: Measures of Significant Project Impacts to Congestion on Circulation Element Road Segments: Allowable Increases on Congested Road Segments

LOS	Two-Lane Road	Four-Lane Road
E	200 ADT	400 ADT
F	100 ADT	200 ADT

Source: Table 1, *Guidelines for Determining Significance and Report Format and Content Requirements Transportation and Traffic* (County of San Diego 2011).

1. By adding proposed project trips to all other trips from a list of projects, these same tables are used to determine if total cumulative impacts are significant. If cumulative impacts are found to be significant, each project that contributes additional trips must mitigate a share of the cumulative impacts.
2. The County of San Diego may also determine impacts have occurred on roads even when a project's direct or cumulative impacts do not trigger an unacceptable LOS, when such traffic uses a significant amount of remaining road capacity.

ADT = average daily trips
LOS = levels of service

- The additional or redistributed vehicular trips generated by the proposed project will cause a residential street to exceed its design capacity.

Thresholds of Significance for Two-Lane Highway Segments with Signalized Intersection Spacing Over 1 Mile

As defined in the County Guidelines, measures of significant project impacts to two-lane highway segments with signalized intersection spacing over 1 mi are based on allowable increases in daily project and cumulative project traffic on segments operating at unacceptable LOS (i.e., LOS E or F). A significant project impact will occur if additional or redistributed vehicular trips generated by the project are found to cause a segment to operate at an unacceptable LOS or exceed the specific thresholds of increase in volume as identified in Table C.

Table C: Measures of Significant Project Impacts to Congestion – Allowable Increases on Two-Lane Highways with Signalized Intersection Spacing Over 1 Mile

LOS	LOS Criteria	Impact Significance Level
E	> 16,200 ADT	> 325 ADT
F	> 22,900 ADT	> 225 ADT

Source: Table 3, *Guidelines for Determining Significance and Report Format and Content Requirements Transportation and Traffic* (County of San Diego 2011).

ADT= average daily trips
LOS = levels of service

Thresholds of Significance for Two-Lane Highway Segments with Signalized Intersection Spacing Less Than 1 Mile

Similar to the significance thresholds for roadway segments and two-lane highway segments with signalized intersection spacing over 1 mi, a significant project impact will occur if additional or redistributed vehicular trips generated by the project cause a segment to operate at an unacceptable LOS or exceed the specific thresholds of increase as identified in Table D.

Table D: Measures of Significant Project Impacts to Congestion – Allowable Increases on Two-Lane Highways with Signalized Intersection Spacing Less Than 1 Mile

LOS	Signalized
E	Delay of 2 seconds or less
F	Delay of 1 second, or 5 peak-hour trips or less on a critical movement

Source: Table 4, *Guidelines for Determining Significance and Report Format and Content Requirements Transportation and Traffic* (County of San Diego 2011).
LOS = level of service

Unlike the significance thresholds for roadway and other two-lane highway segments, the thresholds of increase for two-lane highways with signalized intersection spacing less than 1 mi are based solely on the LOS and delay values of adjacent signalized intersections.

Freeway Segment Analysis Methodology

Freeway performance analysis is based on procedures developed by Caltrans District 11 to calculate performance measures similar to those used for roadway and two-lane highway segment analysis. Specifically, peak-hour freeway segment volumes estimated from average daily trips (ADT) data and adjusted for truck presence and directionality factors are compared to an ideal base freeway lane capacity of 2,350 passenger cars per hour per lane (pc/h/ln). The resultant peak-hour freeway v/c ratios are assigned LOS grades much like those assigned to roadway and two-lane highway segment v/c ratios, with LOS A representing the lowest v/c ratios and LOS F representing operations exceeding capacity. The corresponding LOS and v/c ratios are shown below.

Level of Service	V/C
A	< 0.41
B	0.42–0.62
C	0.63–0.79
D	0.80–0.92
E	0.93–1.00
F	> 1.00

V/C = volume-to-capacity

LOS D or better is used as the threshold for acceptable freeway operations in this analysis.

Ramp Intersection Capacity Analysis Methodology

Ramp intersection capacity analysis has been conducted for all signalized highway intersections using intersecting lane volume (ILV) procedures as described in Topic 406 of the Caltrans HDM. This methodology of assessing peak-hour intersection operations does not provide as detailed an analysis as the HCM 2010 methodology utilized for peak-hour intersection operations analysis and should be considered a secondary validation to the HCM 2010 analysis. The performance measure for ramp intersection capacity analysis is ILV per hour, with ILV per hour values of 1,200 or less representative of operations within capacity, values of 1,201 to 1,500 representative of operations approaching or at capacity, and values of 1,501 or greater representative of operations exceeding capacity. This methodology does not apply to unsignalized highway intersections, which have been analyzed as part of the HCM 2010 intersection analysis.

San Diego Traffic Engineers' Council/Institute of Traffic Engineers Guidelines

Facilities under the jurisdiction of Caltrans comply with the traffic study requirements identified in the SANTEC/ITE Guidelines, as summarized in Table E.

Table E: San Diego Traffic Engineers' Council/Institute of Transportation Engineers Measure of Significant Project Traffic Impacts

LOS with Project ¹	Allowable Change Due to Project Impact ²					
	Freeways		Roadway Segments		Signalized Intersections	Ramp Metering
	v/c	Speed (mph)	v/c	Speed (mph)	Delay (sec)	Delay (min)
E and F (or ramp meter delays above 15 min)	0.01	1	0.02	1	2	2

Source: SANTEC/ITE Guidelines for Traffic Impact Studies in the San Diego Region (SANTEC/ITE 2008).

¹ All LOS measurements are based on HCM procedures for peak-hour conditions. However, v/c ratios for roadway segments may be estimated on an ADT/24-hour traffic volume basis. The acceptable LOS for freeways, roadways, and intersections is generally D (although the acceptable LOS is C for undeveloped or not densely developed locations, per jurisdiction definitions). For metered freeway ramps, LOS does not apply. However, ramp meter delays above 15 minutes are considered excessive.

² If a proposed project's traffic causes the values shown in the table to be exceeded, the impacts are determined to be significant. These impact changes may be measured with appropriate computer programs or expanded manual spreadsheets. The project applicant shall then identify feasible mitigation (within the TIS) that will maintain the traffic facility at an acceptable LOS. If the LOS with the proposed project becomes unacceptable (see Note 1), or if the project adds a significant amount of peak-hour trips to cause any traffic queues to exceed on- or off-ramp storage capacities, the project applicant shall be responsible for mitigating significant impact changes.

ADT = average daily trips

HCM = *Highway Capacity Manual*

LOS = levels of service

min = minute/minutes

mph = miles per hour

SANTEC/ITE = San Diego Traffic Engineers' Council/Institute of Transportation Engineers

sec = second/seconds

TIS = Traffic Impact Study

v/c = volume-to-capacity

EXISTING TRANSPORTATION CONDITIONS

This section describes the study area roadway network and traffic conditions at the time of the preparation of this TIS. Counts Unlimited collected daily and peak-hour traffic data between winter 2018 and spring 2019 at study area intersections and roadway links. Local schools were in session and the weather was dry on the data collection day.

Existing Roadway Network

Figure 3 illustrates existing study area intersection geometrics and traffic controls.

Freeway and Highway Facilities

Interstate 15. I-15 is a grade-separated eight-lane roadway facility that runs north-south through San Diego, Riverside, and San Bernardino Counties. Within the study area, an interchange at Old Highway 395 provides regional access for the proposed project. The posted speed limit is 70 miles per hour (mph) along I-15 in the project vicinity.

State Route 76. SR-76 is a four-lane divided roadway that runs east-west from Oceanside to Mesa Grande. Within the study area, two study area intersections on SR-76 (at Olive Hill Road-Camino Del Rey and at Old Highway 395) provide regional access for the proposed project. The posted speed limit is 55 mph along SR-76 in the project vicinity.

Roadway Facilities

Dulin Road. Dulin Road is a two-lane undivided road that runs east-west and is offset at Old Highway 395. The eastern terminus of Dulin Road is classified as a 2.1E Community Collector in the County General Plan Mobility Element. The proposed project's northerly access point (Access 5) will be a gated access point located at the western terminus of Dulin Road. The project will extend the pavement at the western terminus of Dulin Road.

West Lilac Road. West Lilac Road is primarily a two-lane undivided road located south of the project site and is classified as a 2.2E Light Collector in the County General Plan Mobility Element. This roadway runs east-west throughout most of the study area, turning into a north-south 2.2C Light Collector with intermittent turn lanes between Old Highway 395 and Lilac Road. According to the site plan, two of the three access points will take direct access from this road. Sullivan Middle School takes access solely from West Lilac Road. There is no posted speed limit. A formal speed limit of 45 mph was recommended by the County Traffic Advisory Committee based on a speed survey conducted in 2015. This speed survey found 85th percentile speeds of 46 to 47 mph adjacent to the project intersection.

Camino Del Rey. Camino Del Rey is primarily a two-lane road located south of the project site. Camino Del Rey is classified as a 2.2C Light Collector, with the exception of the segment between SR-76 and Camino Del Cielo, where it is a 4.2B Boulevard with intermittent turn lanes, according to the County General Plan Mobility Element. It is currently a two-lane divided roadway with intermittent turn lanes. This roadway runs east-west throughout the study area. Camino Del Rey acts as one of the connecting roadways between SR-76 and I-15. Bonsall Elementary School has access points on Camino Del Rey near the intersection of Old River Road/Camino Del Rey.

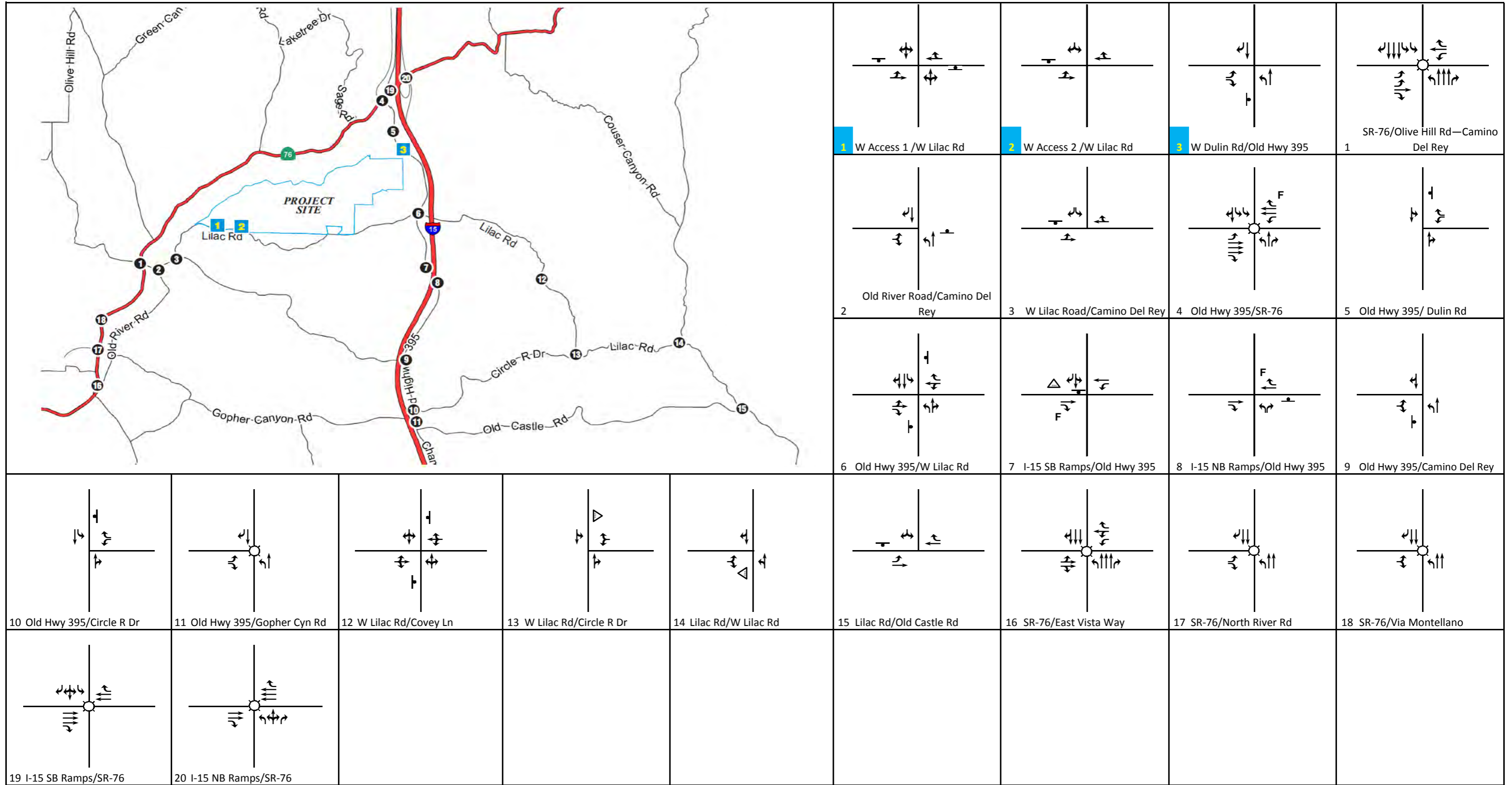

LSA

LEGEND

- Signal
- Stop Sign
- Free Right Turn
- Yield

FIGURE 3

Ocean Breeze Ranch Traffic Impact Study
Existing Intersection Geometries

Old River Road. Old River Road is primarily a two-lane undivided road located south of the project site, with a Traffic Calming Area (two-lane divided roadway with speed bumps and a decreased speed limit) south of Camino Del Rey. Old River Road is classified as a 2.2C Light Collector with improvement options in the County General Plan Mobility Element. This roadway runs north-south throughout the study area. Bonsall Elementary School has access points on Old River Road near the intersection of Old River Road/Camino Del Rey.

Old Highway 395. Old Highway 395 is a two-lane undivided road located east of the project site. According to the County General Plan Mobility Element, the segment of Old Highway 395 (Fallbrook Community Planned Area (CPA) boundary to West Lilac Road) is classified as a 2.1D Community Collector with improvement options, the segment between West Lilac Road to the I-15 is classified as a 4.2B Boulevard with intermittent turn lanes, and the segment between the I-15 interchange to North County Metro Subregion boundary is classified as a 4.1B Major Road with intermittent turn lanes south of the I-15 southbound ramps. This roadway runs north-south throughout the study area, parallel to I-15, which it crosses from the west to the east on the east side of the project site.

Lilac Road. Lilac Road is a two-lane undivided road located east of the project site and is classified in the County General Plan Mobility Element as a 2.2E Light Collector from the Valley Center CPA boundary to SR-76, and as a 2.1C Community Collector with intermittent turn lanes from Anthony Road to Old Castle Road. This roadway runs north-south through the study area.

Study Area Intersections

As shown on Figure 1, the study area includes the following intersections:

1. SR-76/Olive Hill Road-Camino Del Rey
2. Old River Road/Camino Del Rey
3. West Lilac Road/Camino Del Rey
4. Old Highway 395/SR-76
5. Old Highway 395/Dulin Road
6. Old Highway 395/West Lilac Road
7. I-15 southbound ramps/Old Highway 395
8. I-15 northbound ramps/Old Highway 395
9. Old Highway 395/Camino Del Rey
10. Old Highway 395/Circle R Drive
11. Old Highway 395/Gopher Canyon Road
12. West Lilac Road/Covey Lane
13. West Lilac Road/Circle R Drive
14. Lilac Road/West Lilac Road
15. Lilac Road/Old Castle Road
16. SR-76/Old River Road—East Vista Way
17. SR-76/North River Road
18. SR-76/Via Montellano
19. I-15 southbound ramps/SR-76
20. I-15 northbound ramps/SR-76

The project proposes to take access via new public roads connecting at two locations to West Lilac Road with a third access location at a gated access point through the existing western terminus of Dulin Road northeast of the site. The two access points along West Lilac Road will be assessed under Existing Plus Project and Existing Plus Cumulative Projects Plus Project conditions only.

Study Area Roadway Segments

Roadway analysis was conducted at the following segments within the study area:

1. Dulin Road from Old Highway 395 to Lake Circle Drive
2. West Lilac Road from Camino Del Rey to Vessels Ranch Road
3. West Lilac Road from Rawhide Ranch Road to Bobritt Lane
4. West Lilac Road from Old Highway 395 to Ranchos Ladera Road
5. West Lilac Road from I-15 to Standel Lane
6. West Lilac Road from Circle R Drive to Lal Bagh Lane
7. West Lilac Road from Diaz Road to North Berry Road
8. Camino Del Rey from Old River Road to West Lilac Road
9. Lilac Road from West Lilac Road to Old Castle Road
10. Old Highway 395 from SR-76 to Dulin Road
11. Old Highway 395 from Dulin Road (north) to Dulin Road (south)
12. Old Highway 395 from West Lilac Road to Via Urner Road
13. Old Highway 395 from I-15 southbound ramps to I-15 northbound ramps
14. Old Highway 395 from Camino Del Rey to Nelson Way
15. Old Highway 395 from Circle R Drive to Camino Del Rey
16. Old Highway 395 from Circle R Drive to Gopher Canyon Road
17. Old River Road from Golf Club Drive to Dentro De Lomas Road
18. Camino Del Rey west of Via Maria Elena

Pedestrian Facilities

Due to the rural nature of the study area, the presence of sidewalks is infrequent and sidewalks exist exclusively along the roadway frontage of some residential developments. A continuous pedestrian mobility network does not exist at this time. Pedestrian counts were conducted for five Caltrans-controlled study intersection as requested by Caltrans staff. Pedestrian volumes were developed and entered into the Synchro analysis for the intersections of SR-76/Olive Hill Road-Camino Del Rey and Old Highway 395/SR-76. To present a conservative analysis, the highest observed volume in the a.m. or p.m. peak hour (four pedestrians) was applied to all Caltrans intersections.

Bicycle Facilities

Class II bike lanes currently exist on both sides of Old Highway 395 through the length of the study area, from Fallbrook to the north to Escondido to the south. Future bike facilities as shown in the County General Plan Mobility Element include the following:

- **Class I Bike Path**
 - SR-76 for the length of the Bonsall Preserve

- **Class II Bike Lanes**

- SR-76 from the City of Oceanside to the Community of Fallbrook
- Old Highway 395 from the Community of Fallbrook to Hidden Meadows
- West Lilac Road from Camino Del Rey to Old Highway 395
- Camino Del Rey from Old River Road to Old Highway 395

Transit Facilities

Although existing transit services are limited, the Bonsall area is served by the North County Transit District (NCTD). A stop for Route 306 (Fallbrook to Vista Via Mission Road) is located along SR-76 at Camino Del Rey and a Park and Ride for Route 388/389 (Escondido to Pala) on the northeast corner of Old Highway 395/SR-76.

Existing Volumes

Figure 4 illustrates the weekday peak-hour intersection turning movement volumes collected by Counts Unlimited. Appendix A contains study area intersection and roadway segment count data.

Existing Level of Service Analysis

Existing operations at intersections, roadway and two-lane highway segments, and freeway segments were analyzed and identified consistent with the methodologies described in the Methodology section. The results of this Existing conditions analysis are described further by analysis type below.

Intersection Level of Service Analysis

The intersection analysis focuses on the weekday a.m. and p.m. peak-hour LOS at 20 intersections under Existing conditions and is summarized in Table F.

As shown in Table F, all study intersections were found to operate at acceptable LOS (LOS D or better) with the exception of the following intersections:

1. SR-76/Olive Hill Road-Camino Del Rey (LOS E in the a.m. and p.m. peak hours)
3. West Lilac Road/Camino Del Rey (LOS E in the a.m. peak hour)
4. Old Highway 395/SR-76 (LOS E in the a.m. peak hour)
5. Old Highway 395/Dulin Road (LOS E in the a.m. peak hour)
10. Old Highway 395/Circle R Drive (LOS F in the a.m. and p.m. peak hours)
16. SR-76/Old River Road–East Vista Way (LOS E in the p.m. peak hour)

HCM 2010 intersection LOS worksheets are included in Appendix B.

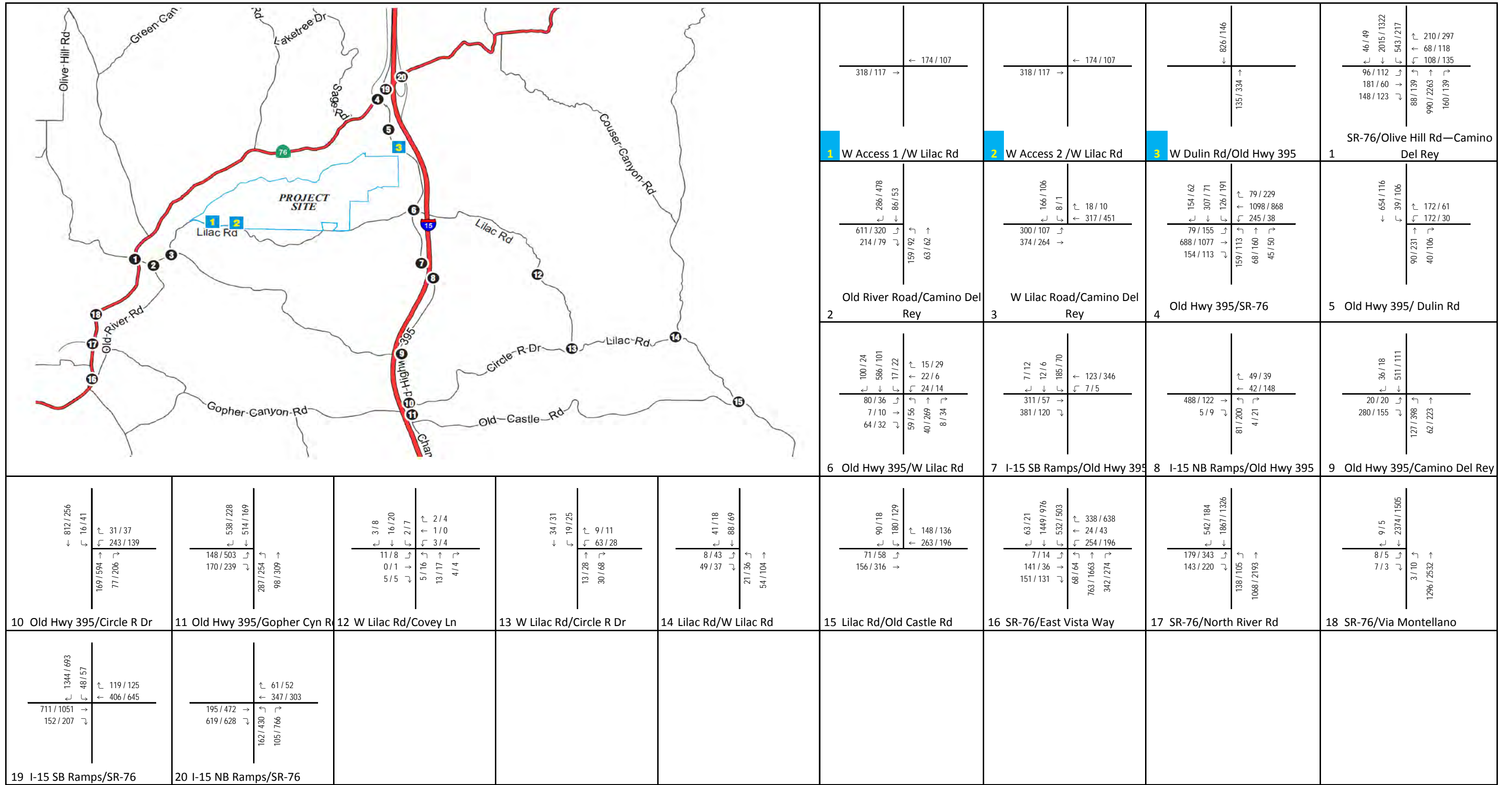

LSA LEGEND
 XXXX / YYYY AM / PM Volume

FIGURE 4

Ocean Breeze Ranch Traffic Impact Study
 Existing Peak-Hour Volumes (AM/PM)

Table F: Existing Intersection LOS Summary

Intersection ¹	Existing					
	AM			PM		
	Delay (sec) ²	LOS	Crit. Mov. ²	Delay (sec)	LOS	Crit. Mov. ²
1 SR-76/Olive Hill Road-Camino Del Rey (signalized)	56.3	E	-	55.2	E	-
2 Old River Road/Camino Del Rey	10.1	B	NBL	9.2	A	NBL
3 West Lilac Road/Camino Del Rey	48.3	E	SBL	21.1	C	SBL
4 Old Highway 395/SR-76 (signalized)	65.8	E	-	35.4	D	-
5 Old Highway 395/Dulin Road	46.4	E	WBL	15.0	C	WBL
6 Old Highway 395/West Lilac Road	33.0	D	EBL	17.9	C	EBL
7 I-15 SB Ramps/Old Highway 395	16.6	C	SBL	12.8	B	SBL
8 I-15 NB Ramps/Old Highway 395	15.5	C	NBL	13.0	B	NBL
9 Old Highway 395/Camino Del Rey	25.8	D	EBL	14.3	B	EBL
10 Old Highway 395/Circle R Drive	171.5	F	WBL	58.2	F	WBL
11 Old Highway 395/Gopher Canyon Road (signalized)	20.5	C	-	22.5	C	-
12 West Lilac Road/Covey Lane	8.8	A	EBL/WBL	9.1	A	EBL
13 West Lilac Road/Circle R Drive	9.5	A	WBL	9.5	A	WBL
14 Lilac Road/West Lilac Road	9.4	A	EBL	10.2	B	EBL
15 Lilac Road/Old Castle Road	22.1	C	SBL	17.4	C	SBL
16 SR-76/Old River Road–East Vista Way (signalized)	42.1	D	-	68.9	E	-
17 SR-76/North River Road (signalized)	23.3	C	-	31.6	C	-
18 SR-76/Via Montellano (signalized)	8.8	A	-	8.3	A	-
19 I-15 southbound ramps/SR-76 (signalized)	18.9	B	-	11.9	B	-
20 I-15 northbound ramps/SR-76 (signalized)	6.9	A	-	11.0	B	-

Note: E = Unsatisfactory LOS

¹ Intersections are unsignalized unless otherwise noted.

² Critical movement for unsignalized intersections.

Crit. Mov. = critical movement NB = northbound sec = second/seconds
I-15 = Interstate 15 SB = southbound SR-76 = State Route 76
LOS = levels of service

Roadway/Two-Lane Highway Segment Volume and Level of Service Analysis

The daily roadway and two-lane highway segment analysis focuses on 18 roadway/two-lane highway segments listed previously in this section. As shown in Table G, all study area roadway and two-lane highway segments are operating at acceptable LOS.

Freeway Segment Level of Service Analysis

The peak-hour freeway LOS analysis focuses on the three SR-76 segments west of Olive Hill Road, one SR-76 segment east of Old Highway 395, and two I-15 segments north and south of the I-15/Old Highway 395 interchange. As shown in Table H, both I-15 freeway segments currently operate at LOS F, which is greater than the threshold for acceptable freeway operations. Neither Caltrans nor the County have plans to make improvements at these locations. The four SR-76 segments currently operate at acceptable LOS.

Ramp Intersection Capacity Analysis

As shown in Table I, peak-hour ramp intersection capacity analysis was conducted for the signalized intersections of SR-76/Olive Hill Road-Camino Del Rey and SR-76/Old Highway 395. The peak-hour ramp intersection capacity analysis shows that the two signalized highway intersections are operating within capacity.

Table G: Existing Average Daily Traffic Volumes and Levels of Service

Roadway	Segment		Cross-Section	Classification Number	LOS Threshold (LOS D) ¹	Existing	
						ADT	LOS
Dulin Road	1	Old Highway 395 to Lake Circle Drive	2 Lane	2.1E	10,900	4,258	C
West Lilac Road	2	Camino Del Rey to Vessels Ranch Road	2 Lane	2.2E	10,900	2,928	B
	3	Rawhide Ranch Road to Bobritt Lane	2 Lane	2.2E	10,900	2,735	B
	4	Old Highway 395 to Ranchos Ladera Road	2 Lane	2.2E	10,900	2,633	B
	5	I-15 to Standel Lane	2 Lane	2.2E	10,900	1,606	A
	6	Circle R Drive to Lal Bagh Lane	2 Lane	2.2E	10,900	1,010	A
	7	Diaz Road to North Berry Road	2 Lane	2.2E	10,900	1,351	A
Camino Del Rey	8	Old River Road to West Lilac Road	2 Lane	2.2C ²	13,500	11,166	D
	18	W/O Via Maria Elena	2 Lane	2.2C	13,500	6,517	C
Lilac Road	9	West Lilac Road to Old Castle Road	2 Lane	2.2E	10,900	3,614	B
Old River Road	17	Golf Club Drive to Dentre De Lomas Road	2 Lane	2.2C	13,500	2,409	A

Two-Lane Highway	Segment		Cross-Section	Classification Number	LOS Threshold (LOS D) ¹	Existing	
						ADT	LOS
Old Highway 395	10	SR-76 to Dulin Road	2-Lane Hwy	2.1D	16,200	7,046	C
	11	Dulin Road (north) to Dulin Road (south)	2-Lane Hwy	2.1D	16,200	6,698	C
	12	West Lilac Road to Via Urner Road	2-Lane Hwy	2.1D	16,200	6,416	C
	13	I-15 SB ramps to I-15 NB ramps	2-Lane Hwy	4.1B	16,200	5,216	A
	14	Camino Del Rey to Nelson Way	2-Lane Hwy	4.1B	16,200	4,967	A
	15	Circle R Drive to Camino Del Rey	2-Lane Hwy	4.1B	16,200	11,948	A
	16	Circle R Drive to Gopher Canyon Road	2-Lane Hwy	4.1B	16,200	13,933	B

¹ LOS D thresholds are based on the measures of significant project impacts to two-lane highway segments with signalized intersection spacing over 1 mile, per the *Guidelines for Determining Significance and Report Format and Content Requirements Transportation and Traffic* (County of San Diego 2011).

² Camino Del Rey between Old River Road and West Lilac Road is planned to be built out to a class 4.2 Boulevard with intermittent turn lanes, according to the *San Diego County General Plan Mobility Element* (County of San Diego 2015). However, this change has not occurred in the Existing condition.

ADT = average daily trips

Hwy = Highway

I-15 = Interstate 15

LOS = level of service

NB = northbound

SB = southbound

SR-76 = State Route 76

W/O = west of

Table H: Existing Freeway Segment Level of Service Analysis

Freeway	Segment	Lanes per Direction	PHF	Heavy Vehicle (%) ^{2,3}	Existing ADT ¹	Peak Hour (%)	Peak Directional Split	Existing			
								Total Two-Way Peak Hour Volume ¹	Demand pc/h/ln	D/C	LOS
SR-76	Old Highway 395 to Jct. Rte. 15	2	0.95	13.3	30,500	8.5	0.79	2,600	640	0.272	A
	Olive Hill Road to Vista Way	2	0.95	5.8	39,000	8.8	0.63	3,450	614	0.261	A
	Vista Way to Santa Fe Road	2	0.95	6.2	37,000	8.8	0.63	3,250	588	0.250	A
	Santa Fe Road to College Boulevard (Oceanside)	3	0.95	5.0	50,000	9.1	0.52	4,450	671	0.286	A
I-15	SR-76 to Old Highway 395	4	0.95	9.4	142,000	7.4	0.76	10,500	2,363	1.006	F
	Old Highway 395 to Gopher Canyon Road	4	0.95	9.4	138,000	7.8	0.76	10,800	2,431	1.034	F

Note: = Unsatisfactory LOS

¹ Existing ADT and peak-hour volumes were obtained from Caltrans' 2017 Traffic Volumes on California State Highways.

² Existing heavy vehicle percentage obtained from 2016 Annual Average Daily Truck Traffic on the California State Highway System (Caltrans 2017b).

³ Heavy vehicle factor of 2.36 calculated from Heavy Vehicle Mix from 2016 Annual Average Daily Truck Traffic on the California State Highway System.

ADT = average daily trips

D/C = demand-to-capacity ratio

I-15 = Interstate 15

LOS = level of service

pc/h/ln = passenger cars per hour per lane

PHF = peak hour factor

SR-76 = State Route 76

Table I: Existing Ramp Intersection Capacity Analysis

Ramp Intersection	Peak Hour	Existing	
		ILV/Hour	Within Capacity? (1,500)
SR-76/Olive Hill Road-Camino Del Rey	AM	1,335	Yes
	PM	1,313	Yes
SR-76/Old Highway 395	AM	1,339	Yes
	PM	1,169	Yes

ILV = intersection lane volume

SR-76 = State Route 76

PROJECT TRAFFIC

Project Description

The project site (located in Traffic Analysis Zone [TAZ] 165) consists primarily of single-family residential, one middle school, orchards, agriculture, and inactive use. The project includes the construction of 396 DUs (15 estate DUs and 381 single-family detached DUs). The project proposes to take access via new public roads connecting at two locations with West Lilac Road with a third access point through the existing western terminus of Dulin Road northeast of the site. The existing on-site equestrian center will be preserved for the private use of its owners and, therefore, is not anticipated to generate external vehicular trips.

Project Phasing

For the purposes of this analysis, it is assumed that this project will be built in one phase. Project phasing may be proposed by the applicant at a subsequent time. Such phasing would require analysis of the timing of improvements relative to the construction of homes to ensure improvements are completed prior to completion of homes which give rise to the need for improvements.

Project Trip Generation, Distribution, and Assignment

For the purpose of disclosing the approximate number of trips generated by the proposed project, trip rates contained in the SANDAG (*Not So*) *Brief Guide of Vehicular Traffic Generation Rates for the San Diego Region* (2003) were utilized. The project trip generation using the SANDAG trip rates is shown in Table J.

Table J: Project Trip Generation Summary

Land Use	Size	Unit	ADT	AM Peak Hour			PM Peak Hour		
				In	Out	Total	In	Out	Total
Trip Rates¹									
Estate Housing		DU	12.00	0.29	0.67	0.96	0.84	0.36	1.20
Single Family Detached (Urbanizing Area)		DU	10.00	0.24	0.56	0.80	0.70	0.30	1.00
Project Trip Generation									
Estate Housing	15	DU	180	5	10	15	13	5	18
Single Family Detached (Urbanizing Area)	381	DU	3,860	92	213	305	267	114	381
Total	396	DU	3,990	97	223	320	280	119	399

¹ Trip rates referenced from the San Diego Association of Governments (SANDAG) (*Not So*) *Brief Guide of Vehicular Traffic Generation Rates for the San Diego Region* (2003).

ADT = average daily trips

DU = dwelling unit

Project Trip Generation

As shown in Table J, the proposed 396 DU project is forecast to generate 3,990 ADT, 320 a.m. peak-hour trips (97 inbound and 223 outbound), and 399 p.m. peak-hour trips (280 inbound and 119 outbound).

Project Trip Distribution and Assignment

Directions of approach to and departure from the site are based on the SANDAG Series 12 select zone assignments for the project TAZ for a.m. peak-hour, p.m. peak-hour, and daily conditions under the 2050 General Plan Build Out condition. The select zone plot, prepared by SANDAG, is provided in Appendix C. Using the trip generation and distribution percentages from the select zone plot, trips were distributed and assigned in and out of the site, illustrated on Figure 5. The project trip assignment is illustrated on Figure 6.

EXISTING PLUS PROJECT CONDITIONS

The following discussion presents the results of the Existing Plus Project conditions analysis and identifies potential significant circulation impacts at intersections, roadway and two-lane highway segments, and freeway segments. The results of this analysis are described further by analysis type below.

Existing Plus Project Roadway Network and Traffic Volumes

Existing Plus Project traffic conditions were developed by adding the anticipated project traffic described in the Project Traffic section to the Existing traffic volumes. Existing Plus Project study area intersection turning movement volumes are illustrated on Figure 7.

Existing Plus Project Study Area Intersection Level of Service Analysis

The intersection analysis focuses on the weekday a.m. and p.m. peak-hour LOS at 20 intersections under Existing Plus Project conditions and is summarized in Table K.

As shown in Table K, all but seven study area intersections are anticipated to continue operating at acceptable LOS. The following two unsatisfactory study area intersections would have direct project impacts:

3. West Lilac Road/Camino Del Rey (LOS F in the a.m. peak hour)
6. Old Highway 395/West Lilac Road (LOS F in the a.m. peak hour)

Recommendations to mitigate the impacts at the unsatisfactory intersections are discussed in the Impacts and Improvements section of this TIS. HCM 2010 intersection LOS worksheets are included in Appendix B.

Existing Plus Project Study Area Intersection Roadway/Two-Lane Highway Segment Level of Service Analysis

As shown in Table L, all study area roadway and two-lane highway segments are anticipated to continue to operate at acceptable capacity levels. Consistent with the County Guidelines thresholds of significance described in the Methodology section, the project will not significantly impact any of the study area roadway and two-lane highway segments.

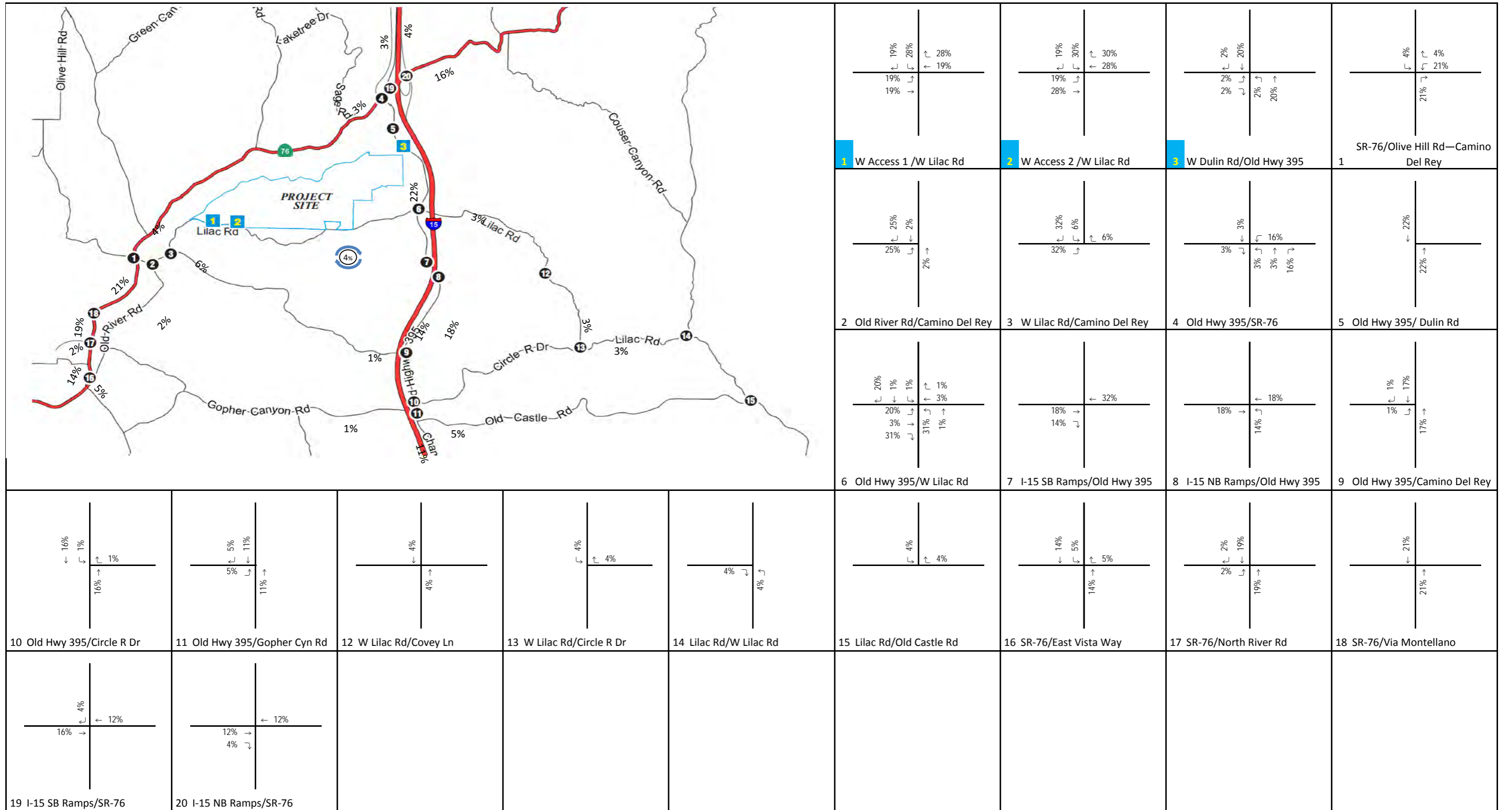
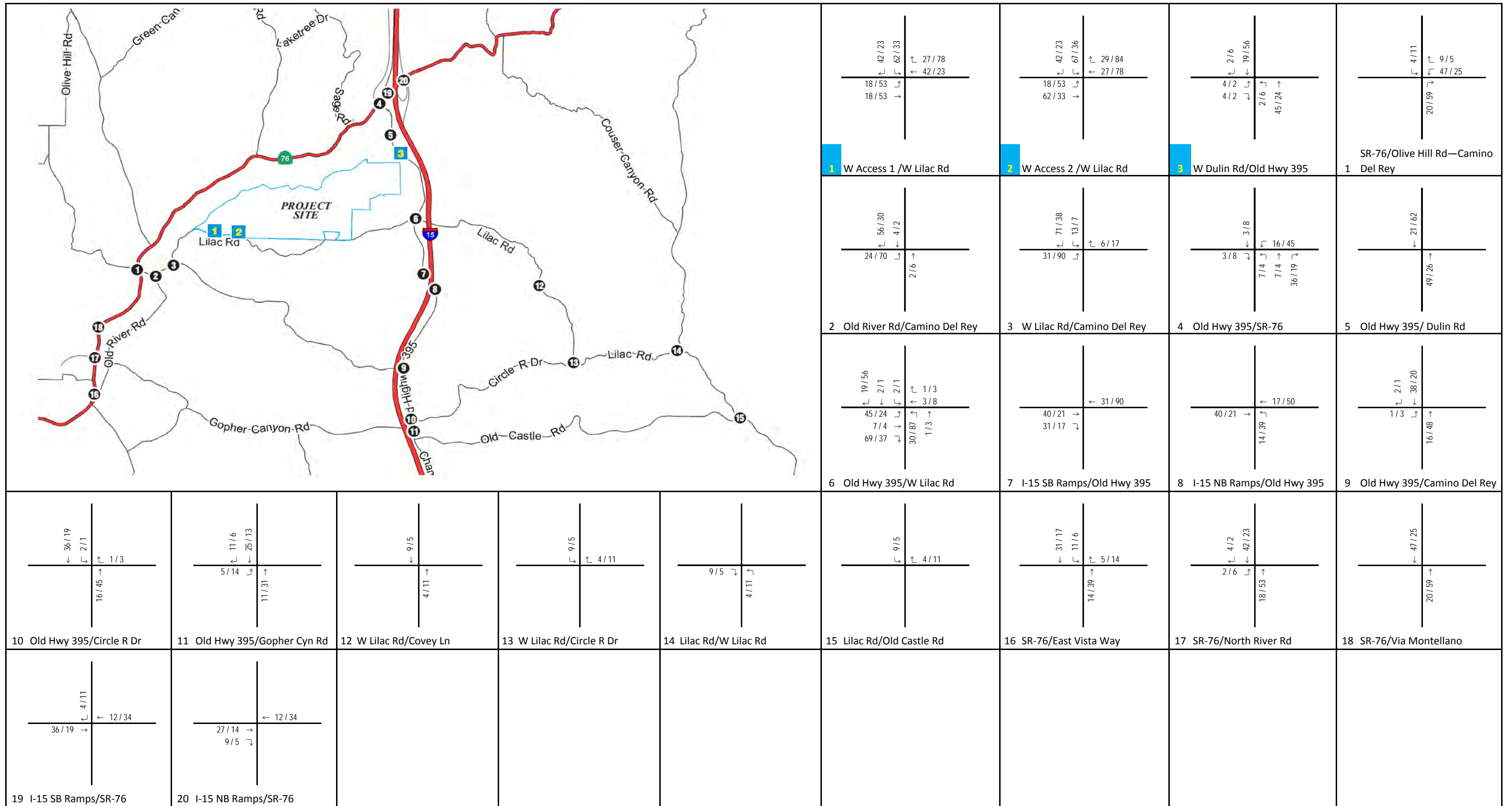

FIGURE 5



LEGEND

% Project Trip Distribution Percentages



LEGEND
XXX / YYY AM / PM Volume

FIGURE 6

Ocean Breeze Ranch Traffic Impact Study
Project Peak-Hour Volumes (AM/PM)

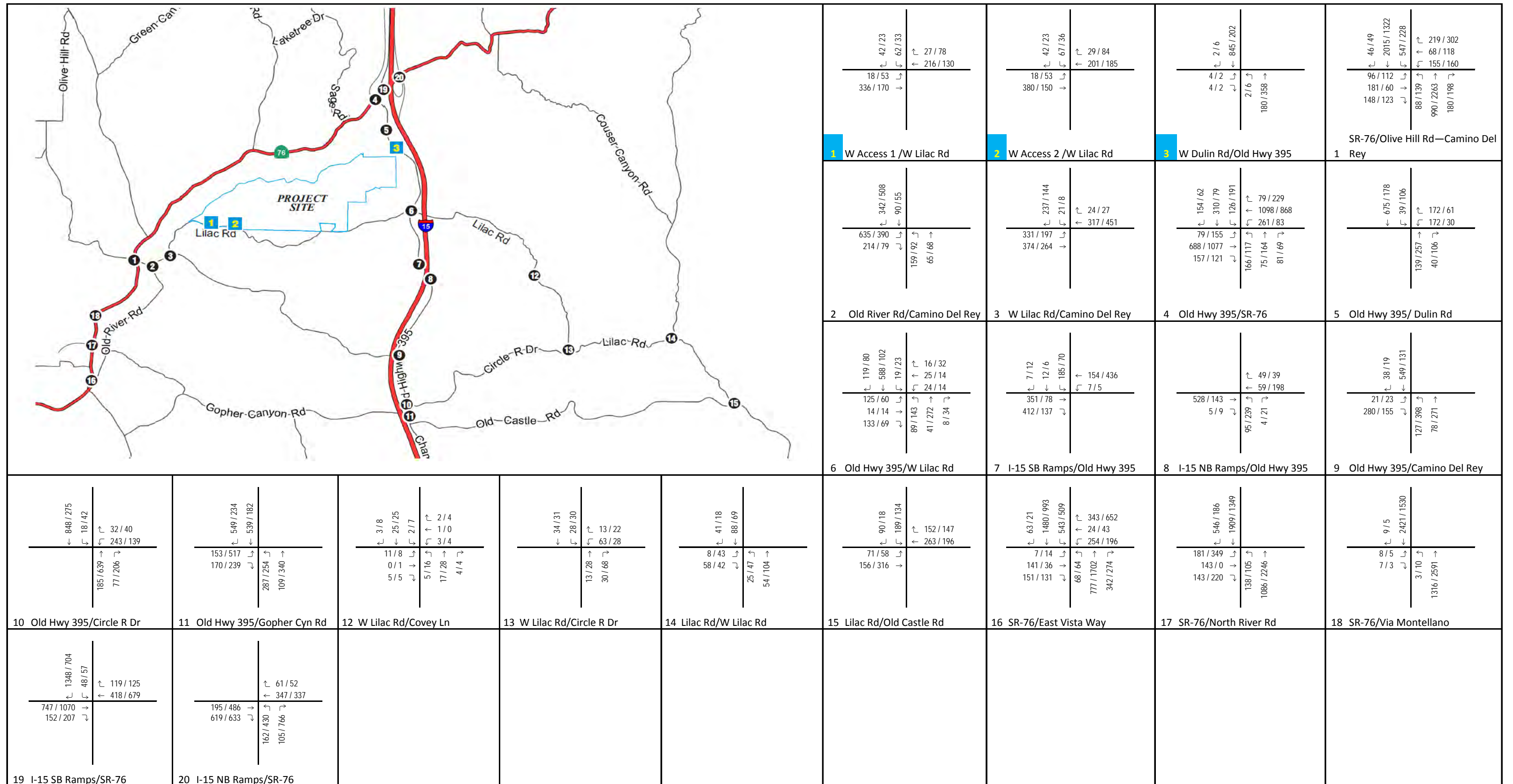

FIGURE 7



LEGEND
 XXX / YYY AM / PM Volume

Ocean Breeze Ranch Traffic Impact Study
 Existing Plus Project Peak-Hour Volumes (AM/PM)

Table K: Existing Plus Project Intersection Level of Service Summary

Intersection	Existing						Existing Plus Project						Peak-Hour Δ^1		Sig. Impact?	
	AM			PM			AM			PM			AM	PM		
	Delay (sec)	LOS	Crit. Mov. ²	Delay (sec)	LOS	Crit. Mov. ²	Delay (sec)	LOS	Crit. Mov. ²	Delay (sec)	LOS	Crit. Mov. ²	Delay (sec)/Crit. Trips			
1	SR-76/Olive Hill Road-Camino Del Rey*	56.3	E	-	55.2	E	-	57.9	E	-	56.7	E	-	1.6	1.5	No
2	Old River Road/Camino Del Rey	10.1	B	NBL	9.2	A	NBL	10.2	B	NBL	9.2	A	NBL	0.1	0.0	No
3	West Lilac Road/Camino Del Rey	48.3	E	SBL	21.1	C	SBL	69.8	F	SBL	31.0	D	SBL	13 trips	7 trips	YES
4	Old Highway 395/SR-76*	65.8	E	-	35.4	D	-	67.2	E	-	36.6	D	-	1.4	1.2	No
5	Old Highway 395/Dulin Road ⁴	46.4	E	WBL	15.0	C	WBL	61.9	F	WBL	16.5	C	WBL	0 trips	0 trips	No
6	Old Highway 395/West Lilac Road	33.0	D	EBL	17.9	C	EBL	76.1	F	EBL	34.9	D	EBL	43.1	17.0	YES
7	I-15 SB Ramps/Old Highway 395	16.6	C	SBL	12.8	B	SBL	18.9	C	SBL	14.5	B	SBL	2.3	1.7	No
8	I-15 NB Ramps/Old Highway 395	15.5	C	NBL	13.0	B	NBL	17.5	C	NBL	15.8	C	NBL	2.0	2.8	No
9	Old Highway 395/Camino Del Rey	25.8	D	EBL	14.3	B	EBL	29.8	D	EBL	16.1	C	EBL	4.0	1.8	No
10	Old Highway 395/Circle R Drive ⁴	171.5	F	WBL	58.2	F	WBL	217.0	F	WBL	78.3	F	WBL	1 trip	3 trips	No
11	Old Highway 395/Gopher Canyon Road*	20.5	C	-	22.5	C	-	21.2	C	-	25.2	C	-	0.7	2.7	No
12	West Lilac Road/Covey Lane	8.8	A	EBL/WBL	9.1	A	EBL	8.9	A	EBL/WBL	9.2	A	EBL	0.1	0.1	No
13	West Lilac Road/Circle R Drive	9.5	A	WBL	9.5	A	WBL	9.6	A	WBL	9.4	A	WBL	0.1	-0.1 ³	No
14	Lilac Road/West Lilac Road	9.4	A	EBL	10.2	B	EBL	9.4	A	EBL	10.3	B	EBL	0.0	0.1	No
15	Lilac Road/Old Castle Road	22.1	C	SBL	17.4	C	SBL	23.1	C	SBL	17.7	C	SBL	1.0	0.3	No
16	SR-76/Old River Rd-E Vista Way ⁵	42.1	D	-	68.9	E	-	43.0	D	-	71.5	E	-	0.9	2.6	No
17	SR-76/North River Road*	23.3	C	-	31.6	C	-	24.2	C	-	35.4	D	-	0.9	3.8	No
18	SR-76/Via Montellano*	8.8	A	-	8.3	A	-	9.4	A	-	9.3	A	-	0.6	1.0	No
19	I-15 SB Ramps/SR-76*	18.9	B	-	11.9	B	-	19.6	B	-	12.1	B	-	0.7	0.2	No
20	I-15 NB Ramps/SR-76*	6.9	A	-	11.0	B	-	6.9	A	-	11.1	B	-	0.0	0.1	No

Note: = Unsatisfactory LOS

* Signalized intersection

¹ Delay is reported for all signalized intersections and for unsignalized intersections operating at LOS D or better. The # of trips for the critical movement is shown for unsignalized intersections operating at LOS E/F per County guidelines.

² Critical movements for unsignalized intersections.

³ Synchro calculates the average delay by taking into account the delay of all movements and the number of vehicles at an intersection. If adding project traffic to a movement does not increase delay significantly, the overall average delay may go down.

⁴ Per County significance impact threshold criteria, project trips on the critical movement do not exceed County thresholds; therefore, there are no direct impacts.

⁵ Per Caltrans threshold criteria, there is no direct impact.

Crit. Mov. = critical movement

LOS = levels of service

SB = southbound

Sig. Impact = significant impact

EBL = eastbound left

NB = northbound

SBL = southbound left

SR-76 = State Route 76

I-15 = Interstate 15

NBL = northbound left

sec = second/seconds

WBL = westbound left

Table L: Existing Plus Project Average Daily Traffic Volumes and Levels of Service

Roadway	Segment		Cross-Section	Classification Number	LOS Threshold (LOS D) ¹	Existing		Project ADT	Existing Plus Project		Significant Impact?
						ADT	LOS		ADT	LOS	
Dulin Road	1	Old Highway 395 to Lake Circle Drive	2 Lane	2.1E	10,900	4,258	C	0	4,258	C	No
West Lilac Road	2	Camino Del Rey to Vessels Ranch Road	2 Lane	2.2E	10,900	2,928	B	1,516	4,444	C	No
	3	Rawhide Ranch Road to Bobritt Lane	2 Lane	2.2E	10,900	2,735	B	2,154	4,889	C	No
	4	Old Highway 395 to Ranchos Ladera Road	2 Lane	2.2E	10,900	2,633	B	2,154	4,787	C	No
	5	I-15 to Standel Lane	2 Lane	2.2E	10,900	1,606	A	160	1,766	A	No
	6	Circle R Drive to Lal Bagh Lane	2 Lane	2.2E	10,900	1,010	A	160	1,170	A	No
	7	Díaz Road to North Berry Road	2 Lane	2.2E	10,900	1,351	A	160	1,511	A	No
Camino Del Rey	8	Old River Road to West Lilac Road	2 Lane	2.2C ²	13,500	11,166	D	1,276	12,442	D	No
	18	W/O Via Maria Elena	2 Lane	2.2C	13,500	6,517	C	240	6,757	C	No
Lilac Road	9	West Lilac Road to Old Castle Road	2 Lane	2.2E	10,900	3,614	B	160	3,774	B	No
Old River Road	17	Golf Club Drive to Dentro De Lomas Road	2 Lane	2.2C	13,500	2,409	A	80	2,489	A	No
Two-Lane Highway	Segment		Cross-Section	Classification Number	LOS Threshold (LOS D) ¹	Existing		Project ADT	Existing Plus Project		Significant Impact?
						ADT	LOS		ADT	LOS	
Old Highway 395	10	SR-76 to Dulin Road	2-Lane Hwy	2.1D	16,200	7,046	C	886	7,932	C	No
	11	Dulin Road (north) to Dulin Road (south)	2-Lane Hwy	2.1D	16,200	6,698	C	886	7,584	C	No
	12	West Lilac Road to Via Urner Road	2-Lane Hwy	2.1D	16,200	6,416	C	886	7,302	C	No
	13	I-15 SB ramps to I-15 NB ramps	2-Lane Hwy	4.1B	16,200	5,216	A	1,008	6,224	A	No
	14	Camino Del Rey to Nelson Way	2-Lane Hwy	4.1B	16,200	4,967	A	724	5,691	A	No
	15	Circle R Drive to Camino Del Rey	2-Lane Hwy	4.1B	16,200	11,948	A	684	12,632	A	No
	16	Circle R Drive to Gopher Canyon Road	2-Lane Hwy	4.1B	16,200	13,933	B	644	14,577	B	No

¹ LOS D thresholds are based on the measures of significant project impacts to two-lane highway segments with signalized intersection spacing over 1 mile, per the *Guidelines for Determining Significance and Report Format and Content Requirements Transportation and Traffic* (County of San Diego 2011).

² Camino Del Rey between Old River Road and West Lilac Road is planned to be built out to a class 4.2 Boulevard with intermittent turn lanes, according to the *San Diego County General Plan* Mobility Element (County of San Diego 2015). However, this change has not occurred in the Existing condition.

ADT = average daily trips NB = northbound
Hwy = Highway SB = southbound
I-15 = Interstate 15 SR-76 = State Route 76
LOS = level of service W/O = west of

Existing Plus Project Freeway Segment Level of Service Analysis

As shown in Table M, both I-15 freeway segments are anticipated to continue to operate at unacceptable LOS F with the addition of project traffic. According to the SANTEC/ITE thresholds of significance described in the Methodology section, a project impact would occur if project traffic causes a freeway segment operating at unacceptable LOS to increase its v/c ratio of by 0.01 or greater. As shown in Table M, the project will not cause the freeway segments to exceed the threshold of significance by 0.01. The four SR-76 freeway segments are anticipated to continue operating at acceptable LOS A with the addition of project traffic. Therefore, the project will not significantly impact any freeway segments.

Existing Plus Project Ramp Intersection Capacity Analysis

As shown in Table N, peak-hour ramp intersection capacity analysis was conducted for the intersections of SR-76/Olive Hill Road-Camino Del Rey and SR-76/Old Highway 395 under Existing Plus Project conditions. This analysis found the two signalized highway intersections to be operating within capacity. This is consistent with the peak-hour intersection LOS analysis presented in Table K.

CUMULATIVE TRAFFIC CONDITIONS

The Cumulative condition was developed by adding the anticipated traffic from other committed and/or approved (cumulative) projects to the Existing study intersection traffic volumes. The County provided LSA with the Newland Sierra TIA (LLG Engineers 2018a) to obtain information regarding the most up-to-date list of approved and pending projects in the region. The study included a list of 199 cumulative projects. Due to the distance of the cumulative projects from the project (i.e., several miles away), trips generated from cumulative projects 171–199 are not expected to impact the project study intersections. LSA also reviewed the cumulative projects list found in the Lilac Hills Ranch (LHR) TIS (Chen Ryan Associates 2015). The LHR Project and the Ocean Breeze Ranch Project have overlapping study intersections and are in close proximity to each other. Cumulative projects 1–169 of the LHR TIS are identical to cumulative projects 1–170 in the Newland Sierra TIA. Cumulative project 170 in the Newland Sierra TIA is the LHR project.

The cumulative projects list utilized by the recent Newland Sierra development (#1–170) was used for this analysis. The current cumulative project list and map are included in Appendix D.

Cumulative Volumes

The cumulative projects traffic volumes were developed using the traffic volumes from the LHR TIS.

The Existing peak hour intersection traffic volumes from the LHR TIS were subtracted from the Existing Plus Cumulative Projects Plus Project peak hour traffic volumes from the LHR TIS to determine the volumes of the Cumulative projects. Figure 8 illustrates the Cumulative projects peak-hour intersection turning movement volumes. The Cumulative projects volumes were added to the Existing counts to represent the Existing Plus Cumulative Projects condition, as shown on Figure 9.

Table M: Existing Plus Project Freeway Segment Level of Service Analysis

Freeway	Segment	Lanes per Direction	PHF	Heavy Vehicle (%) ^{2,3}	Existing ADT ¹	Peak Hour (%)	Peak Directional Split	Existing				Peak-Hour Project Volume	Existing Plus Project				Δ D/C	Significant Impact?
								Existing Peak Hour ¹	Demand (pc/h/ln)	D/C	LOS		Total Two-Way Peak-Hour Volume	Demand (pc/h/ln)	D/C	LOS		
SR-76	Old Highway 395 to Jct. Rte. 15	2	0.95	13.3%	30,500	8.5	0.79	2,600	640	0.272	A	64	2,664	656	0.279	A	0.007	No
	Olive Hill Road to Vista Way	2	0.95	5.8%	39,000	8.8	0.63	3,450	614	0.261	A	84	3,534	629	0.268	A	0.007	No
	Vista Way to Santa Fe Road	2	0.95	6.2%	37,000	8.8	0.63	3,250	588	0.250	A	72	3,322	601	0.256	A	0.006	No
	Santa Fe Road to College Boulevard (Oceanside)	3	0.95	5.0%	50,000	9.1	0.52	4,550	671	0.286	A	68	4,618	681	0.290	A	0.004	No
I-15	SR-76 to Old Highway 395	4	0.95	9.4%	142,000	7.4	0.76	10,500	2,363	1.006	F	20	10,520	2,368	1.008	F	0.002	No
	Old Highway 395 to Gopher Canyon Road	4	0.95	9.4%	138,000	7.8	0.76	10,800	2,431	1.034	F	32	10,832	2,438	1.037	F	0.003	No

Note: F = Unsatisfactory LOS

¹ Existing ADT and peak-hour volumes were obtained from Caltrans' 2017 Traffic Volumes on California State Highways.

² Existing heavy vehicle percentage obtained from 2016 Annual Average Daily Truck Traffic on the California State Highway System (Caltrans 2017b).

³ Heavy vehicle factor of 2.36 calculated from Heavy Vehicle Mix from 2016 Annual Average Daily Truck Traffic on the California State Highway System.

Δ = change

ADT = average daily trips

Caltrans = California Department of Transportation

PHF = peak hour factor

D/C = demand-to-capacity ratio

I-15 = Interstate 15

pc/h/ln = passenger cars per hour per lane

Jct. = Junction

Table N: Existing Plus Project Ramp Intersection Capacity Analysis

Ramp Intersection	Peak Hour	Existing		Existing Plus Project	
		ILV/Hour	Within Capacity? (1,500)	ILV/Hour	Within Capacity? (1,500)
SR-76/Olive Hill Road-Camino Del Rey	AM	1,335	Yes	1,346	Yes
	PM	1,313	Yes	1,318	Yes
SR-76/Old Highway 395	AM	1,339	Yes	1,365	Yes
	PM	1,169	Yes	1,173	Yes

ILV = Intersection Lane Vehicles

SR-76 = State Route 76

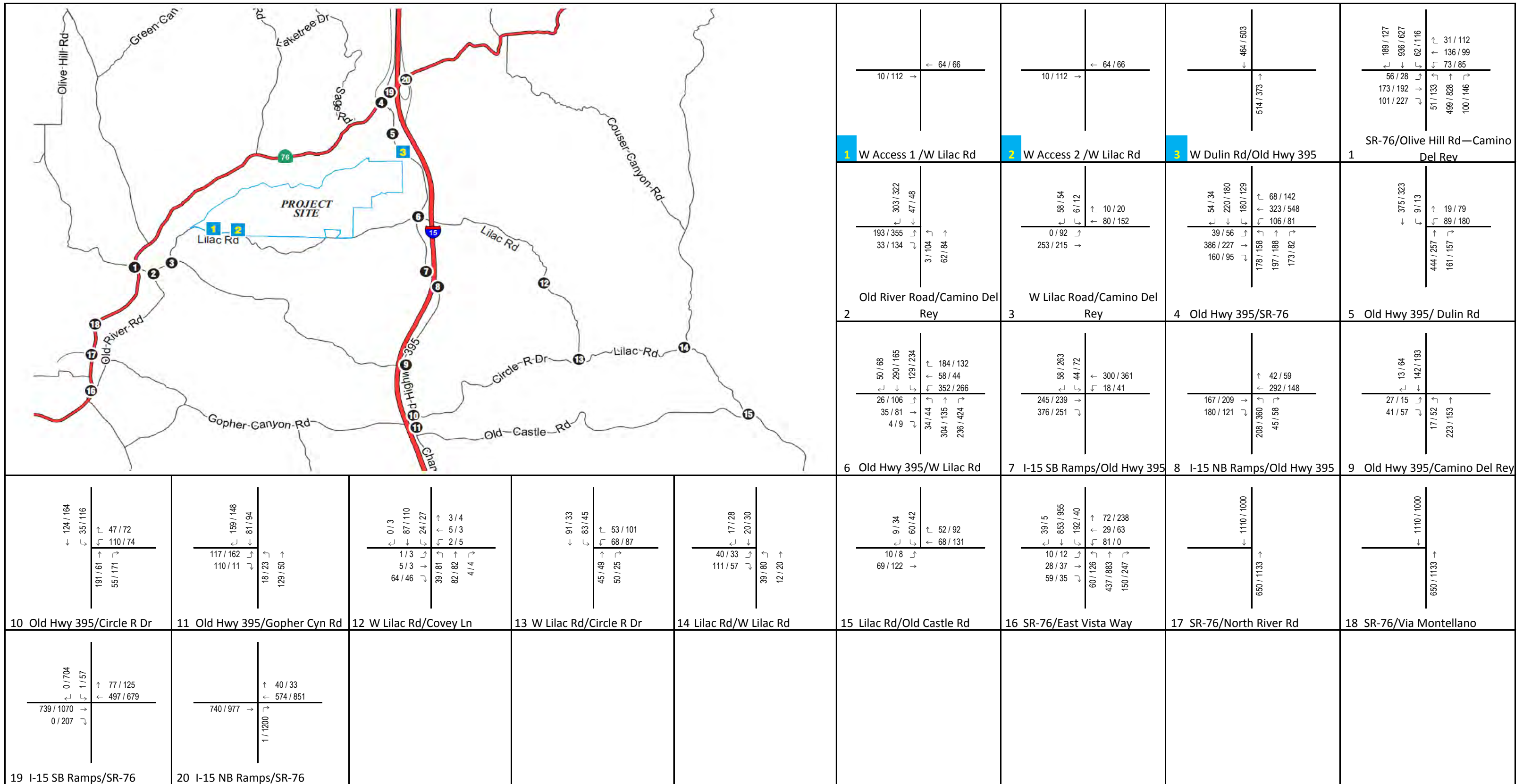

LEGEND
123 / 456 AM / PM Volume

FIGURE 8

Ocean Breeze Ranch Traffic Impact Study
Cumulative Projects Peak-Hour Volumes (AM/PM)

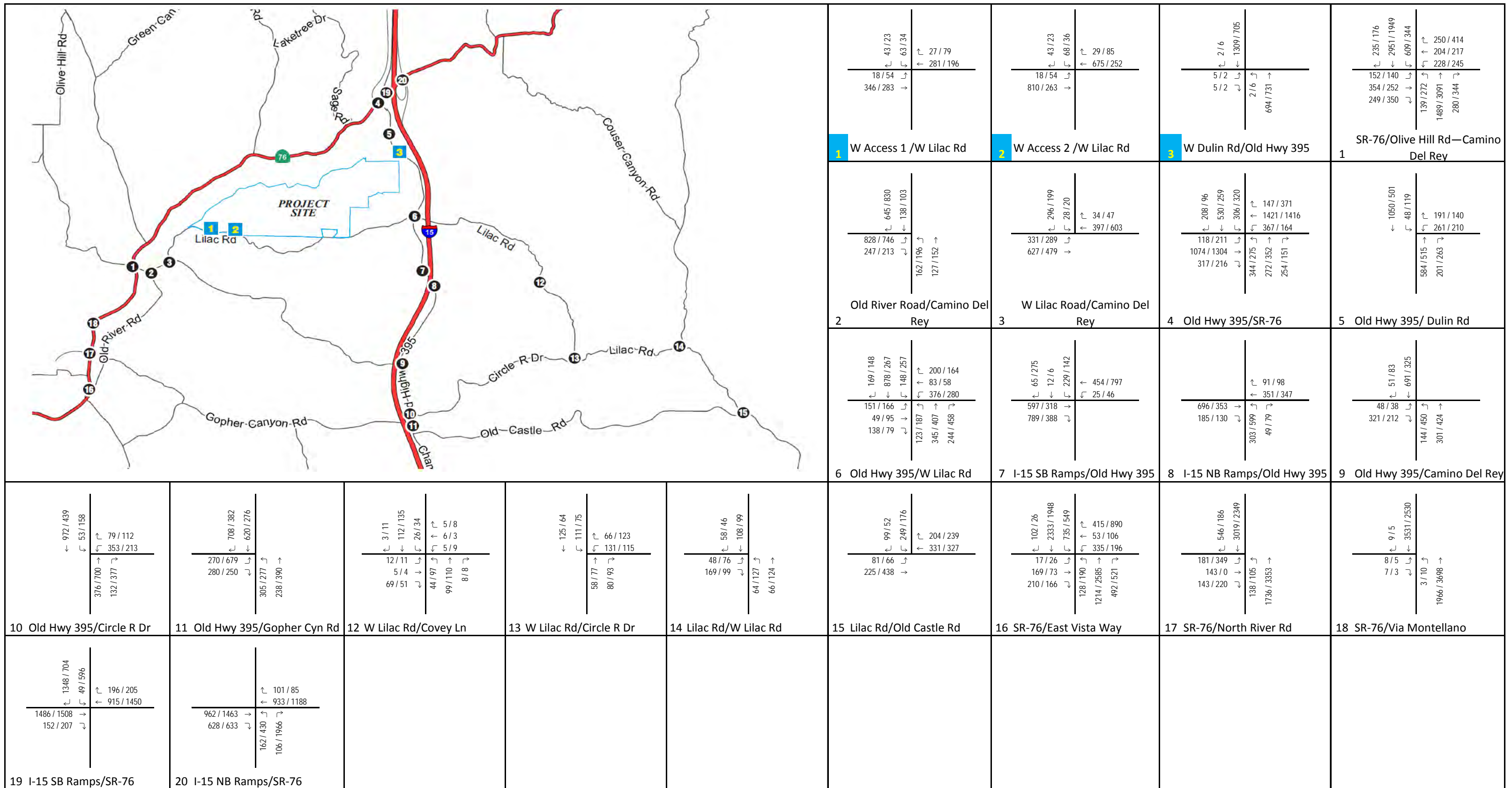

FIGURE 9



LEGEND
123 / 456 AM / PM Volume

Ocean Breeze Ranch Traffic Impact Study
Existing Plus Cumulative Projects Plus Project Peak-Hour Volumes (AM/PM)

Existing Plus Cumulative Projects Plus Project Conditions

The following discussion presents the results of the Existing Plus Cumulative Projects Plus Project conditions analysis and identifies potential significant circulation impacts at intersections, roadway and two-lane highway segments, and freeway segments. The results of this analysis are described further by analysis type below.

Existing Plus Cumulative Projects Plus Project Roadway Network and Traffic Volumes

Existing Plus Cumulative Projects Plus Project traffic conditions were developed by adding the anticipated project traffic described in the Project Traffic section to Cumulative traffic volumes. Cumulative Plus Project study area intersection turning movement volumes are illustrated on Figure 9.

Existing Plus Cumulative Projects Plus Project Study Area Intersection Level of Service Analysis

The intersection analysis focuses on the weekday a.m. and p.m. peak-hour LOS at 20 intersections under Existing Plus Cumulative Projects Plus Project conditions and is summarized in Table O.

As shown in Table O, the following study area intersections are anticipated to operate at unsatisfactory LOS. The unsatisfactory study area intersections are the following:

1. SR-76/Olive Hill Road-Camino Del Rey (LOS F in the a.m. and p.m. peak hours)
3. West Lilac Road/Camino Del Rey (LOS F in the a.m. and p.m. peak hours)
4. Old Highway 395/SR-76 (LOS F in the a.m. and p.m. peak hours)
5. Old Highway 395/Dulin Road (LOS F in the a.m. and p.m. peak hours)
6. Old Highway 395/West Lilac Road (LOS F in the a.m. and p.m. peak hours)
7. I-15 southbound ramps/Old Highway 395 (LOS F in the a.m. and p.m. peak hours)
8. I-15 northbound ramps/Old Highway 395 (LOS F in the a.m. and p.m. peak hours)
9. Old Highway 395/Camino Del Rey (LOS F in the a.m. and p.m. peak hours)
10. Old Highway 395/Circle R Drive (LOS F in the a.m. and p.m. peak hours)
11. Old Highway 395/Gopher Canyon Road (LOS E in the p.m. peak hour)
12. Lilac Road/Old Castle Road (LOS F in the a.m. peak hour and LOS E in the p.m. peak hour)
16. SR-76/Old River Road–East Vista Way (LOS F in the a.m. and p.m. peak hours)
17. SR-76/North River Road (LOS F in the a.m. and p.m. peak hours)
18. SR-76/Via Montellano (LOS F in the a.m. and p.m. peak hours)
20. I-15 northbound ramps/SR-76 (LOS F in the p.m. peak hour)

Recommendations to improve the operations at the unsatisfactory intersections are discussed in the Existing Plus Cumulative Projects Plus Project Impacts and Improvements section of this TIS. HCM 2010 intersection LOS worksheets are included in Appendix B.

Table O: Existing Plus Cumulative Projects Plus Project Intersection Level of Service Summary

Intersection	Existing						Existing Plus Cumulative Projects Plus Project						Sig. Impact?
	AM			PM			AM			PM			
	Delay (sec)	LOS	Crit. Mov. ²	Delay (sec)	LOS	Crit. Mov. ²	Delay (sec)	LOS	Crit. Mov. ²	Delay (sec)	LOS	Crit. Mov. ²	
1 SR-76/Olive Hill Road-Camino Del Rey ¹	56.3	E	-	55.2	E	-	159.5	F	-	192.3	F	-	YES
2 Old River Road/Camino Del Rey	10.1	B	NBL	9.2	A	NBL	10.8	B	NBL	10.2	B	NBL	No
3 West Lilac Road/Camino Del Rey	48.3	E	SBL	21.1	C	SBL	291.2	F	SBL	174.0	F	SBL	YES
4 Old Highway 395/SR-76 ¹	65.8	E	-	35.4	D	-	164.2	F	-	116.1	F	-	YES
5 Old Highway 395/Dulin Road	46.4	E	WBL	15.0	C	WBL	>300	F	WBL	>300	F	WBL	No ³
6 Old Highway 395/West Lilac Road	33.0	D	EBL	17.9	C	EBL	>300	F	EBL	>300	F	WBL	YES
7 I-15 SB Ramps/Old Highway 395	16.6	C	SBL	12.8	B	SBL	252.7	F	SBL	158.3	F	SBL	YES
8 I-15 NB Ramps/Old Highway 395	15.5	C	NBL	13.0	B	NBL	>300	F	NBL	>300	F	NBL	YES
9 Old Highway 395/Camino Del Rey	25.8	D	EBL	14.3	B	EBL	190.2	F	EBL	121.1	F	EBL	YES
10 Old Highway 395/Circle R Drive	171.5	F	WBL	58.2	F	WBL	>300	F	WBL	>300	F	WBL	No ⁴
11 Old Highway 395/Gopher Canyon Road ¹	20.5	C	-	22.5	C	-	51.4	D	-	99.2	E	-	YES
12 West Lilac Road/Covey Lane	8.8	A	EBL/WBL	9.1	A	EBL	11.7	B	EBL/WBL	14.3	B	EBL	No
13 West Lilac Road/Circle R Drive	9.5	A	WBL	9.5	A	WBL	15.7	C	WBL	13.2	B	WBL	No
14 Lilac Road/West Lilac Road	9.4	A	EBL	10.2	B	EBL	11.7	B	EBL	14.0	B	EBL	No
15 Lilac Road/Old Castle Road	22.1	C	SBL	17.4	C	SBL	72.7	F	SBL	40.9	E	SBL	YES
16 SR-76/Old River Road-E Vista Way ¹	42.1	D	-	68.9	E	-	90.7	F	-	157.4	F	-	YES
17 SR-76/North River Road ¹	23.3	C	-	31.6	C	-	105.2	F	-	146.7	F	-	YES
18 SR-76/Via Montellano ¹	8.8	A	-	8.3	A	-	96.9	F	-	97.8	F	-	YES
19 I-15 southbound ramps/SR-76 ¹	18.9	B	-	11.9	B	-	38.1	D	-	20.9	C	-	No
20 I-15 northbound ramps/SR-76 ¹	6.9	A	-	11.0	B	-	6.9	A	-	137.8	F	-	No ⁵

Note: = Unsatisfactory LOS

¹ Signalized intersection

² Critical movement for unsignalized intersection

³ The project contributes 0 trips in both peak periods to the critical movement and therefore does not meet the County threshold for significant impact.

⁴ The project contributes 1 trip (a.m.) and 3 trips (p.m.) to the critical movement and therefore does not meet the County threshold for significant impact.

⁵ The project contributes less than 1 second of delay at this intersection and therefore does not meet the County threshold for significant impact.

Crit. Mov. = critical movement SB = southbound
EBL = eastbound left SBL = southbound left
I-15 = Interstate 15 sec = second/seconds
LOS = levels of service sig. = significant
NB = northbound SR-76 = State Route 76
NBL = northbound left WBL = westbound left

Existing Plus Cumulative Projects Plus Project Study Area Intersection Roadway/Two-Lane Highway Segment Level of Service Analysis

As shown in Table P, all study area roadway and two-lane highway segments are anticipated to continue to operate at acceptable capacity levels, except for the following roadway/two-lane highway segments with significant impacts:

- Camino Del Rey (Old River Road to West Lilac Road)—LOS E
- Old Highway 395 (Circle R Drive to Camino Del Rey)—LOS E
- Old Highway 395 (Circle R Drive to Gopher Canyon Road)—LOS E

Recommendations to improve the conditions at the unsatisfactory two-lane highway segments/roadways are discussed in the Existing Plus Cumulative Projects Plus Project Impacts and Improvements section of this TIS.

Existing Plus Cumulative Projects Plus Project Freeway Segment Level of Service Analysis

As shown in Table Q, both I-15 freeway segments are anticipated to continue to operate at unacceptable LOS F with the addition of project traffic. According to the SANTEC/ITE thresholds of significance described in the Methodology section, a project impact would occur if project traffic causes a freeway segment operating at unacceptable LOS to increase its v/c ratio of by 0.01 or greater. As shown in Table Q, the project will not cause the freeway segments to exceed the threshold of significance by 0.01 in the Existing Plus Cumulative Projects with No Project condition. The four SR-76 freeway segments are anticipated to continue operating at acceptable LOS with the addition of project traffic. Therefore, the project will not significantly impact any freeway segments.

Existing Plus Cumulative Projects Plus Project Ramp Intersection Capacity Analysis

As shown in Table R, peak-hour ramp intersection capacity analysis was conducted for the intersections of SR-76/Olive Hill Road-Camino Del Rey and SR-76/Old Highway 395 under Existing Plus Cumulative Projects Plus Project conditions. This analysis found the two signalized highway intersections to not be operating within capacity during both the a.m. and p.m. peak hours.

SITE ACCESS AND ON-SITE CIRCULATION

This section discusses the operations and design of both the project's site access points and its on-site circulation.

Site Access

Specifically, this section will assess the operations and configuration of the project access points. Intersection operations methodology consistent with what was performed for off-site intersections will be applied to the two proposed access points along West Lilac Road in an effort to assess peak-hour operations. In order to assess the placement and design of each access point, characteristics including project intersection (Road A1/West Lilac Road and Road A3/West Lilac Road) configuration, and placement in relation to potential high traffic activity areas (e.g., Sullivan Middle School) will be analyzed.

Table P: Existing Plus Cumulative Projects Plus Project Average Daily Traffic Volumes and Levels of Service

Roadway	Segment		Cross-Section	Classification Number	LOS Threshold (LOS D) ¹	Existing + Cumulative Projects		Project ADT	Existing + Cumulative Projects + Project		Significant Impact?
						ADT	LOS		ADT	LOS	
Dulin Road	1	Old Highway 395 to Lake Circle Drive	2 Lane	2.1E	10,900	9,758	C	0	9,758	C	No
West Lilac Road	2	Camino Del Rey to Vessels Ranch Road	2 Lane	2.2E	10,900	3,988	B	1,530	5,504	C	No
	3	Rawhide Ranch Road to Bobritt Lane	2 Lane	2.2E	10,900	4,125	C	2,174	6,279	C	No
	4	Old Highway 395 to Ranchos Ladera Road	2 Lane	2.2E	10,900	4,023	C	2,174	6,177	C	No
	5	I-15 to Standel Lane	2 Lane	2.2E	10,900	5,301	B	160	5,461	C	No
	6	Circle R Drive to Lal Bagh Lane	2 Lane	2.2E	10,900	3,150	A	162	3,310	A	No
	7	Díaz Road to North Berry Road	2 Lane	2.2E	10,900	3,751	B	162	3,911	B	No
Camino Del Rey	8	Old River Road to West Lilac Road	2 Lane	2.2C ²	13,500	14,486	E	1,288	15,762	E	Yes
	18	W/O Via Maria Elena	2 Lane	2.2C	13,500	9,337	C	242	9,577	C	No
Lilac Road	9	West Lilac Road to Old Castle Road	2 Lane	2.2E	10,900	4,804	B	162	4,964	B	No
Old River Road	17	Golf Club Drive to Dentro De Lomas Road	2 Lane	2.2C	13,500	4,259	B	80	4,339	B	No
Two-Lane Highway	Segment		Cross-Section	Classification Number	LOS Threshold (LOS D) ¹	Existing + Cumulative Projects		Project ADT	Existing + Cumulative Projects + Project		Significant Impact?
		ADT				LOS	ADT		LOS		
Old Highway 395	10	SR-76 to Dulin Road	2-Lane Hwy	2.1D	16,200	12,216	C	886	15,204	D	No
	11	Dulin Road (north) to Dulin Road (south)	2-Lane Hwy	2.1D	16,200	11,283	B	886	12,161	D	No
	12	West Lilac Road to Via Urner Road	2-Lane Hwy	2.1D	16,200	13,306	B	886	14,184	D	No
	13	I-15 SB ramps to I-15 NB ramps	2-Lane Hwy	4.1B	16,200	12,971	A	1,008	13,968	D	No
	14	Camino Del Rey to Nelson Way	2-Lane Hwy	4.1B	16,200	7,242	A	724	7,960	C	No
	15	Circle R Drive to Camino Del Rey	2-Lane Hwy	4.1B	16,200	15,648	C	684	16,466	E	Yes
	16	Circle R Drive to Gopher Canyon Road	2-Lane Hwy	4.1B	16,200	18,613	A	644	19,191	E	Yes

¹ LOS D thresholds are based on the measures of significant project impacts to two-lane highway segments with signalized intersection spacing over 1 mile, per the *Guidelines for Determining Significance and Report Format and Content Requirements Transportation and Traffic* (County of San Diego 2011).

² Camino Del Rey between Old River Road and West Lilac Road is planned to be built out to a class 4.2 Boulevard with intermittent turn lanes, according to the *San Diego County General Plan* Mobility Element (County of San Diego 2015). However, this change has not occurred in the Existing condition.

ADT = average daily traffic NB = northbound
Hwy = Highway SB = southbound
I-15 = Interstate 15 SR-76 = State Route 76
LOS = level of service W/O = west of

Table Q: Existing Plus Cumulative Projects Plus Project Freeway Segment Level of Service Analysis

Freeway	Segment	Lanes Per Direction	PHF	Heavy Vehicle (%) ^{3,4}	Existing + Cumulative ADT ¹	Peak Hour %	Peak Directional Split	Existing + Cumulative				Peak Hour Project Volume ²	Existing+ Cumulative + Project				Δ D/C	Sig. Impact?
								Two-Way Peak-Hour Volume	Demand (pc/h/ln)	D/C	LOS		Total Two-Way Pk Hr Vol	Demand (pc/h/ln)	D/C	LOS		
SR-76	Old Highway 395 to Jct. Rte. 15	2	0.95	13.3	31,520	8.8%	0.81	2,760	691	0.294	A	64	2,824	707	0.301	A	0.007	No
	Olive Hill Road to Vista Way	2	0.95	5.8	41,020	8.9%	0.62	3,660	640	0.272	A	85	3,745	655	0.279	A	0.006	No
	Vista Way to Santa Fe Road	2	0.95	6.2	39,020	8.8%	0.63	3,450	620	0.264	A	73	3,523	633	0.269	A	0.006	No
	Santa Fe Road to College Boulevard (Oceanside)	3	0.95	5.0	52,020	9.3%	0.52	4,830	707	0.301	A	69	4,899	717	0.305	A	0.004	No
I-15	SR-76 to Old Highway 395	4	0.95	9.4	169,920	7.8%	0.76	13,291	2,991	1.273	F	20	13,311	2,996	1.275	F	0.002	No
	Old Highway 395 to Gopher Canyon Road	4	0.95	9.4	167,800	8.1%	0.76	13,551	3,050	1.298	F	32	13,583	3,057	1.301	F	0.003	No

Notes: F = Unsatisfactory LOS

¹ Existing ADT and peak-hour volumes were obtained from Caltrans' 2017 Traffic Volumes on California State Highways. Volumes for the Cumulative Projects were developed by using the p.m. intersection volumes from SR-76 and multiplying by a factor of 10.

² The project is anticipated to add 5 percent of its traffic volume between SR-76 and Old Highway 395 and 8 percent between Old Highway 395 and Gopher Canyon Road.

³ Existing Heavy Vehicle percentage obtained from Caltrans' 2016 Annual Average Daily Truck Traffic on the California State Highway System.

⁴ Heavy vehicle factor of 2.36 calculated from Heavy Vehicle Mix from Caltrans' 2016 Annual Average Daily Truck Traffic on the California State Highway System.

ADT = average daily trips

Caltrans = California Department of Transportation

D/C = demand-to-capacity ratio

(pc/h/ln) = passenger cars per hour per lane

SR-76 = State Route 76

Table R: Existing Plus Cumulative Projects Plus Project Ramp Intersection Capacity Analysis

Ramp Intersection	Peak Hour	Existing Plus Cumulative Plus Project	
		ILV/Hour	Within Capacity? (1,500)
SR-76/Olive Hill Road-Camino Del Rey	AM	1,893	No
	PM	2,066	No
SR-76/Old Highway 395	AM	2,099	No
	PM	1,962	No

ILV = intersection lane volume
SR-76 = State Route 76

Peak-Hour Intersection Operations

Peak-hour intersection operations at the two project intersections with West Lilac Road were assessed for Existing Plus Project and General Plan (2030) peak-hour conditions. General Plan (2030) peak-hour conditions were developed by applying the anticipated growth between Existing daily traffic counts applying General Plan (2030) daily traffic forecasts along West Lilac Road to Existing peak-hour traffic counts.

Project traffic was developed based on the location of each project intersection in relation to the distribution of homes within the project site and the project trip distribution and assignment described in the Project Traffic section of this TIS.

The resulting General Plan (2030) peak-hour volumes were then analyzed using the same HCM 2010 methodology utilized for off-site unsignalized study area intersections. The anticipated LOS of each project intersection on West Lilac Road is shown in Table S.

Table S: Project Intersection Level of Service Summary

Project Intersection	Existing Plus Project				General Plan (2030)			
	AM		PM		AM		PM	
	Delay (sec)	LOS	Delay (sec)	LOS	Delay (sec)	LOS	Delay (sec)	LOS
Road A1/West Lilac Road	13.8	B	11.5	B	15.0	C	9.9	A
Road A3/West Lilac Road	14.4	B	12.1	B	19.6	C	12.9	B

LOS = level of service
sec = second/seconds

As shown in Table S, both project intersections on West Lilac Road are anticipated to operate at acceptable LOS under Existing Plus Project and General Plan (2030) peak-hour conditions. Project intersection peak-hour LOS worksheets are provided in Appendix E.

Peak-hour intersection operations at the two project intersections with West Lilac Road and at Old Highway 395/Dulin Road were assessed for Existing Plus Project and Existing Plus Project Plus Cumulative peak-hour conditions.

As shown in Table T, both project intersections on West Lilac Road are anticipated to operate at acceptable LOS under Existing Plus Project and Existing Plus Project Plus Cumulative conditions. The access intersection of Old Highway 395/Dulin Road operates at satisfactory LOS under the Existing Plus Project condition, but operates at unsatisfactory LOS in the Existing Plus Project Plus Cumulative condition. The project contributes minimal project trips at this intersection. Project intersection peak-hour LOS worksheets are provided in Appendix E.

Table T: Project Access Intersection Level of Service Summary

Project Intersection	Existing Plus Project				Existing Plus Project Plus Cumulative			
	AM		PM		AM		PM	
	Delay (sec)	LOS	Delay (sec)	LOS	Delay (sec)	LOS	Delay (sec)	LOS
Road A1/West Lilac Road	13.8	B	11.5	B	15.1	C	9.9	A
Road A3/West Lilac Road	14.4	B	12.1	B	32.7	D	12.9	B
Old Highway 395/Dulin Road Access ¹	21.1	C	13.1	B	82.1	F	35.6	E

Note: = Unsatisfactory LOS

¹ In the Existing Plus Project Plus Cumulative condition, the project only contributes 4 trips to the eastbound left critical movement.

LOS = level of service

sec = second/seconds

Project Intersection Configuration and Stacking

This section presents the results of the site access assessment conducted for the Existing Plus Project and Existing Plus Cumulative Projects Plus Project conditions. As presented previously in this report, all project intersections are anticipated to operate at satisfactory LOS for all analysis conditions. As part of the site access assessment, existing and potential turn-pocket queuing issues at site access points along West Lilac Road were analyzed using the SimTraffic (Version 10) software.

Table U shows queuing results for Existing and Cumulative Plus Project traffic conditions. Based on the results in Table U, the maximum outbound queue at both Road A project intersections is approximately three vehicles or 75 feet (ft) (25 ft per vehicle) in the Existing Plus Project conditions. The maximum outbound queue at both project intersections is approximately six vehicles or 150 ft in the Cumulative Plus Project conditions. The inbound left-turn movement is anticipated to generate a maximum queue of four vehicles in the p.m. peak hour for both project intersections. The maximum outbound queue for the Old Highway 395/ Dulin Road access is approximately one vehicle or 25 ft in the Existing Plus Project condition. The maximum outbound queue is approximately two vehicles or 50 ft in the Existing Plus Cumulative Projects Plus condition. The inbound left-turn movement is anticipated to generate a maximum queue of approximately two vehicles in the a.m. peak hour.

As stated in the *Left-Turn Accommodations at Unsignalized Intersections* (2013) from the National Cooperative Highway Research Program (NCHRP), a left-turn lane is recommended for a Light Collector roadway segment when there are 50 or more peak-hour vehicles making a left turn.

Table U: Project Intersection Queuing Summary

Project Intersection	Movement	Vehicle Queue Length (ft) ¹			
		Existing Plus Project		Existing Plus Cumulative Projects Plus Project	
		AM Peak Hour	PM Peak Hour	AM Peak Hour	PM Peak Hour
Road A1/West Lilac Road	SBLR	50	56	59	56
	EBL	0	0	47	68
Road A3/West Lilac Road	SBLR	48	69	140	76
	EBL	37	76	26	37
Old Highway 395/Dulin Road Access	EBR	22	0	0	0
	EBL	0	0	41	17
	NBL	0	0	0	27

¹ The 95th percentile queues were calculated by Synchro 10 software.
 ft = foot/feet EBR = eastbound right SBLR = southbound left-right
 EBL = eastbound left NBL = northbound left WBR = westbound right

As shown on Figure 6, 54 p.m. peak-hour vehicles are anticipated to make an inbound left turn into both project intersections along West Lilac Road. Due to delays caused by oncoming traffic in the Existing Plus Cumulative Projects Plus Project condition, this results in anticipated eastbound left-turn queues, shown in Table U, of 68 ft at the western access and 37 ft at the eastern access. The *Public Road Standards (2012), Page 14, Section 4.4, C.5*, for the County Department of Public Works recommends a minimum left-turn storage length of 200 ft with a 120 ft taper at both project intersections along West Lilac Road.

Internal Roadway Circulation

This section assesses the adequacy of the internal roadway system to accommodate future residents in terms of daily vehicular capacity.

Internal daily roadway traffic was developed by determining the routes that motorists would likely use to travel to and from West Lilac Road. The resulting internal roadway ADT along the main internal roads (Roads A and B) is shown on Figure 10. The main internal roads are proposed to be designed to County roadway classification 2.2F – Light Collector with Reduced Shoulder, with right-of-way widths ranging from 52 ft to 60 ft. The internal roadway segment ADT summary is shown in Table V. As shown in Table V, internal project traffic is anticipated to operate well within the design capacity of Roads A and B.

The daily design capacity of Roads A and B is such that if all project traffic were to utilize any single roadway, the cumulative daily demand would be satisfactorily accommodated.

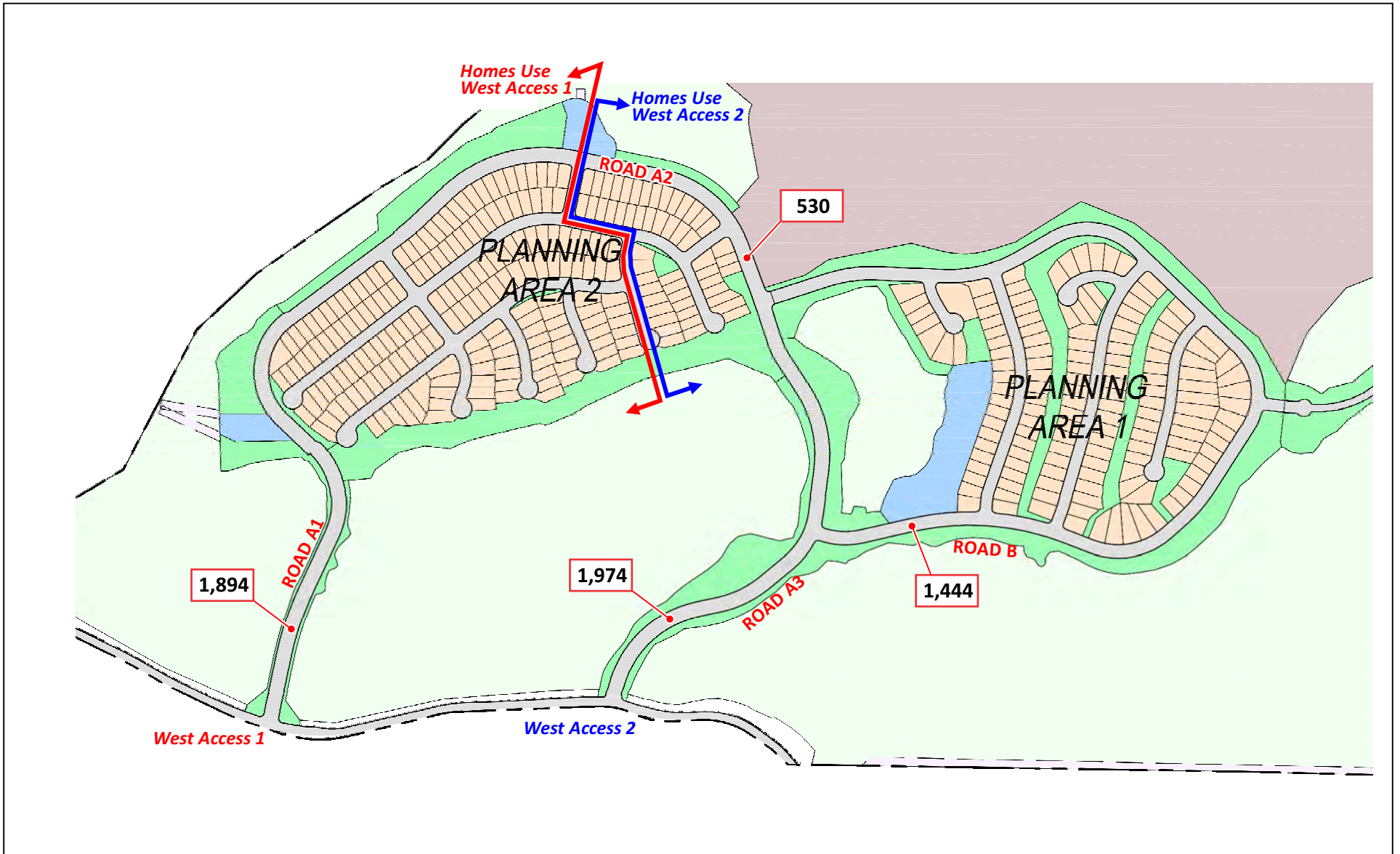
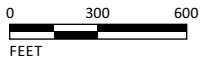

FIGURE 10

LSA

LEGEND

X,XXX - Average Daily Traffic (ADT)



SITE PLAN SOURCE: Project Design Consultants

I:\JCO1501\G\Internal Roadway ADT.cdr (1/10/2019)

Ocean Breeze Ranch Traffic Impact Study
Internal Roadway Average Daily Traffic (ADT)

Table V: Internal Roadway Average Daily Traffic Volumes and Volume-to-Capacity Ratios

Roadway	Classification No.	LOS Threshold (LOS D)	Capacity (LOS E)	Project ADT		
				ADT	v/c	LOS
Road A1	2.2F	8,700	16,200	1,890	0.12	B
Road A2	2.2F	8,700	16,200	530	0.03	A
Road A3	2.2F	8,700	16,200	1,970	0.12	B
Road B	2.2F	8,700	16,200	1,440	0.09	A

ADT = average daily trips
LOS = level of service
v/c = volume-to-capacity ratio

Emergency services are provided access to the single-family homes via the two full-access project intersections on West Lilac Road. The 15 estate DUs typically would not be accessed via these two project intersections as their closest access is via the western terminus of Dulin Road. However, the 15 estate DUs on the eastern portion of the project site can be accessed via West Lilac Road and vice-versa by emergency services through the use of a fire access box controlled gate between the estate and single-family-residential portions of the project site. Emergency vehicles and residents will share access and circulation at the westerly terminus of Dulin Road.

This roadway will be gated. It is likely that a portion of the 15 homes may also use the two project intersections along West Lilac Road to reach regional destinations such as Vista or Oceanside. For the purposes of assessing a worst-case traffic condition, this study has calculated traffic operations with all 15 of these homes using the Dulin Road access and no other routes to West Lilac Road.

Internal Pedestrian Facility Network

The project will include pedestrian circulation (e.g., sidewalks and a recreation trail) that will provide pedestrian connectivity throughout the project site, as shown on Figure 11. The proposed sidewalk along West Lilac Road will be connected to the internal pedestrian routes. The network will allow continuous pedestrian movement throughout the project site. The proposed sidewalk along West Lilac Road can be connected to the greater Bonsall area. A recreation trail, the River Trail would connect the trail system to the eastern edge of the estate lots.

GENERAL PLAN CONSISTENCY ANALYSIS

This section describes the project’s consistency with the County General Plan Land Use Element and Mobility Element at build out of the Land Use Element. This effort utilizes General Plan (2030) forecasts consistent with those used in the County’s latest General Plan Update. The County provided 2030 daily traffic forecasts for the Fallbrook, Bonsall, and Valley Center areas that contain the study area (provided in Appendix F). These forecasts are of the 2030 proposed network, which includes road 3A, a potential future east-west connection between West Lilac Road and Cole Grade Road in the Valley Center area of the County.

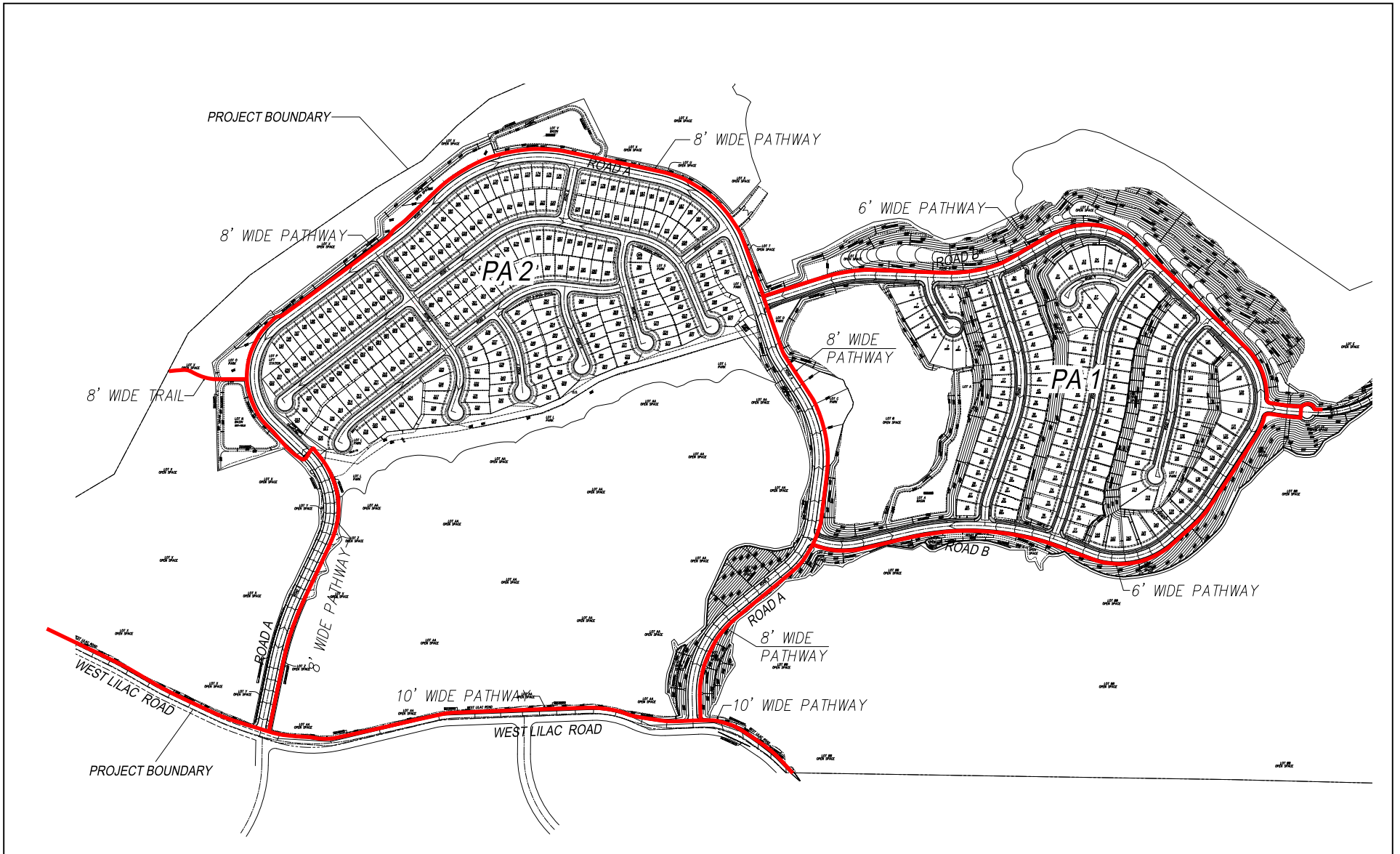
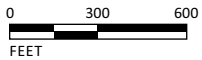

FIGURE 11

LSA

LEGEND

— - Pedestrian Routes



SITE PLAN SOURCE: Project Design Consultants

I:\JCO1501\G\Pedestrian Circulation.cdr (2/7/2019)

Because the project is consistent with the General Plan Land Use Element, the project is included in these General Plan Update traffic volume forecasts. In order to determine the adequacy of the General Plan roadway network under General Plan (2030) conditions, a roadway segment analysis was conducted.

As shown in Table W, the General Plan roadway network is anticipated to adequately service General Plan (2030) levels of traffic, inclusive of traffic generated by the project with the exception of roadway segments of Old Highway 395 from SR-76 to Dulin Road, Dulin Road (North) to Dulin Road (South), and West Lilac Road to Via Urner Road. These roadway segments are forecast to operate at LOS E and are accepted to be deficient under implementation of the County General Plan Update.

SIGNAL WARRANT ANALYSIS

According to County guidelines, if an unsignalized intersection operates at an unsatisfactory LOS E or F in the baseline condition and project trips are added, a signal warrant analysis will be conducted to determine if a traffic signal is required, when signalization is being recommended.

Based on the California Manual of Uniform Traffic Control Devices (MUTCD) 2014 Edition, a traffic signal warrant analysis was conducted for the following intersections in the Existing Plus Project condition:

- West Lilac Road/Camino Del Rey (LOS F in the a.m. peak hour)
- Old Highway 395/West Lilac Road (LOS F in the a.m. peak hour)

The California MUTCD Warrants 1, 2, and 3 were utilized and are based on traffic volume and provide different thresholds for rural and urban settings. The rural setting may be used in the built-up area of an isolated community with a population of less than 10,000 or where the speed limit on a major street is greater than 40 mph. Therefore, the rural setting was examined for Warrants 1, 2, and 3.

Each of the volume warrants was conducted with Existing Plus Project volumes. Since hourly volumes cannot be developed for the project, the higher project peak-hour volume was added to each of the highest existing volumes to present a conservative, worst-case analysis. Additionally, each volume warrant is dependent on the number of lanes of each approach.

The California MUTCD does not have a threshold for the number of warrants met to require the installation of a signal; this analysis has been prepared for disclosure purposes. The California MUTCD signal warrant worksheets as referenced below are provided in Appendix H.

#3 West Lilac Road/Camino Del Rey

Based on the California MUTCD 2014 Edition, Figure 4C-101 (Warrant 3 – Peak hour), this intersection would satisfy Part B, Figure 4C-4, the plot for rural-area approach volumes. Therefore, the peak-hour signal warrant is met for the Existing Plus Project condition during the a.m. peak hour. Although the signal warrant is met, it is at the discretion of the County Public Works

Table W: General Plan (2030) Average Daily Traffic Volumes and Levels of Service

Roadway	Segment		Classification No.1	LOS Threshold (LOS D)	General Plan		Project ADT	General Plan Plus Project	
					ADT	LOS		ADT	LOS
Dulin Road	1	Old Highway 395 to Lake Circle Drive	2.1E	10,900	6,000	C	0	6,000	C
West Lilac Road	2	Camino Del Rey to Vessels Ranch Road	2.2E	10,900	5,200	C	1,516	6,716	C
	3	Rawhide Ranch Road to Bobritt Lane	2.2E	10,900	5,600	C	2,154	7,754	D
	4	Old Highway 395 to Ranchos Ladera Road	2.2E	10,900	7,100	C	2,154	9,254	D
	5	I-15 to Standel Lane	2.2E	10,900	5,300	C	160	5,460	C
	6	Circle R Drive to Lal Bagh Lane	2.2E	10,900	900	A	162	1,062	A
	7	Diaz Road to North Berry Road	2.2E	10,900	1,400	A	160	1,560	A
Camino Del Rey	8	Old River Road to West Lilac Road	4.2B	25,000	13,500	C	1,276	14,776	C
	18	W/O Via Maria Elena	2.2C	13,500	7,400	C	240	7,640	C
Lilac Road	9	West Lilac Road to Old Castle Road	2.2E	10,900	7,500	D	160	7,660	D
Old River Road	17	Golf Club Drive to Dentro De Lomas Road	2.2C	13,500	3,400	B	80	3,480	B
Old Highway 395	10	SR-76 to Dulin Road ²	2.1D	13,500	13,900	E	878	14,778	E
	11	Dulin Road (North) to Dulin Road (South) ²	2.1D	13,500	16,500	E	878	17,378	E
	12	West Lilac Road to Via Urner Road ²	2.1D	13,500	16,100	E	878	16,978	E
	13	I-15 SB Ramps to I-15 NB ramps	4.1B	30,800	17,300	B	997	18,297	B
	14	Camino Del Rey to Nelson Way	4.1B	30,800	15,800	B	718	16,518	B
	15	Circle R Drive to Camino Del Rey	4.1B	30,800	22,200	B	678	22,878	B
	16	Circle R Drive to Gopher Canyon Road	4.1B	30,800	6,100	A	638	6,738	A

Note: **BOLD** = Deficient

¹ General Plan Analysis assumes that all roadway segments have been built out to what is designated in the *San Diego County General Plan* (County of San Diego 2010).

² The County General Plan Update has accepted LOS E/F operations at these roadway segments, per the *San Diego County General Plan* (County of San Diego 2010).

ADT = average daily trips

I-15 = Interstate 15

NB = northbound

SB = southbound

SR-76 = State Route 76

W/O = west of

Department to permit installation of the traffic signal. The LOS worksheets are provided as Appendix G, and the signal warrant worksheet for this intersection is provided in Appendix H.

#6: Old Highway 395/West Lilac Road

Three separate traffic volume signal warrants were performed (Peak Hour, Eight Hour, and Four Hour). Each of the volume warrants was conducted with Existing Plus Project volumes. In the Existing Plus Project condition, 148 trips were added to the northbound and southbound major approaches on Old Highway 395, and 127 trips were added to the eastbound and westbound minor approach on West Lilac Road.

Based on the California MUTCD 2014 Edition, Figure 4C-101 (Warrant 3 – Peak Hour), this intersection would satisfy Part B, Figure 4C-4, the plot for rural-area approach volumes. Therefore, the peak-hour signal warrant is met for the Existing and Existing Plus Project conditions during the a.m. peak hour. A traffic signal is recommended at this location. The signal warrant worksheet for this intersection is provided in Appendix H.

Additionally based on discussion and coordination with County staff, signal warrants (Warrant 1 – Eight hour) and (Warrant 2 – Four hour) from the California MUTCD were also performed.

Daily (24-hour) traffic volumes were collected on roadway segments along West Lilac Road between Camino Del Rey to Vessels Ranch Road on Thursday, November 8, 2018. The corresponding (north) and (south) approach data at the intersection form the basis for the existing traffic volume setting on the major (higher-volume) street (Old Highway 395).

Daily (24-hour) traffic volumes were collected along West Lilac Road between Camino Del Rey to Vessel Ranch Road on Thursday, November 8, 2018. These data form the basis for the existing traffic volume setting on the minor (lower-volume) street (Dulin Road). Weekday a.m. and p.m. peak-hour turning movement major and minor volumes were derived from the roadway daily segment volumes.

Based on the MUTCD 2014 Edition, this intersection would not satisfy Condition A (Minimum Vehicle Volume) or Condition B (Interruption of Continuous Flow) for Figure 4C-101 Warrant 1 – (Eight Hour), but would satisfy Figure 4C-1, the plot for rural-area approach volumes for Warrant 2 – (Four Hour). Therefore, the eight-hour warrant is not met and the four-hour signal warrant is met for the Existing Plus Project conditions. A traffic signal is recommended at this location. The signal warrant worksheet for this intersection is provided in Appendix H.

EXISTING PLUS PROJECT IMPACTS AND IMPROVEMENTS

Intersections

The Existing Plus Project conditions would result in direct project impacts at two study intersections. The following intersection improvements were analyzed and are recommended to mitigate the traffic impacts and return the LOS to acceptable levels.

#3 West Lilac Road/Camino Del Rey

The intersection of West Lilac Road/Camino Del Rey is anticipated to exceed LOS standards in the a.m. peak hour for the Existing and Existing Plus Project conditions. Three improvement options were evaluated as a part of this analysis:

- Option 1 – Roundabout:** Per County guidance, a one-lane, roundabout analysis was performed to evaluate this improvement as a viable alternative. The peak-hour operation of the future roundabout at West Lilac Road/Camino Del Rey was determined using the *SIDRA 7* software. The *SIDRA 7* intersection LOS worksheets and conceptual design are provided as Appendix G. The proposed West Lilac Road/Camino Del Rey roundabout is forecast to operate at a satisfactory LOS in both peak hours.
- Option 2 – Signalization:** As previously mentioned a traffic signal warrant analysis was conducted based on the California (MUTCD) 2014 Edition. The (Warrant 3 – Peak Hour) signal warrant is met for the Existing Plus Project condition during the a.m. peak. The LOS worksheets are provided as Appendix G, and the signal warrant worksheet for this intersection is provided in Appendix H. West Lilac Road/Camino Del Rey is forecast to operate at a satisfactory LOS in both peak hours with a traffic signal.
- Option 3 – All-Way Stop Control and Add an Eastbound Left Turn:** Based on evaluation of this intersection as all-way stop-controlled, it was determined that the number of eastbound left-turning vehicles for Existing Plus Project conditions exceeds the County road standard for left turns without a left-turn lane. Based on the County’s *Public Road Standards (2012)* and input from County staff, a left-turn lane is recommended where the left-turn traffic volume at an intersection is estimated to exceed 300 vehicles during the peak hour. Approximately 300 vehicles currently make this eastbound left-turn movement in the a.m. peak hour. With the addition of project traffic, this number of eastbound left-turning vehicles reaches 331 in the a.m. peak hour, exceeding the County threshold for a left-turn lane.

As a precursor to this improvement option, a dedicated eastbound left-turn lane was considered with the existing stop control at West Lilac Road. However, this would not resolve the delay from the worst performing movement (southbound left), and would still result in unsatisfactory LOS at this intersection.

As such, this improvement option includes implementation of all-way stop control and a dedicated eastbound left-turn lane, as shown below.

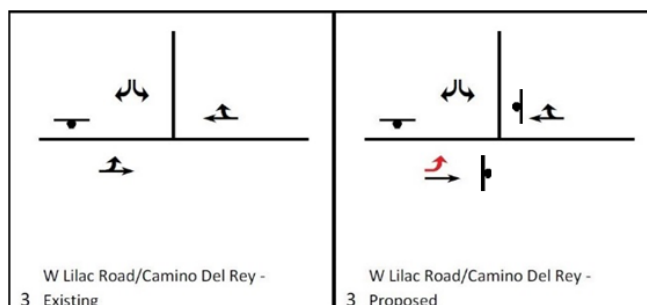

An HCM 2010 analysis was conducted for the proposed all-way stop-controlled intersection of West Lilac Road/Camino Del Rey with the proposed eastbound left-turn lane. The HCM 2010 LOS worksheets are provided as Appendix G. Based on the results of this analysis, the intersection would operate at satisfactory LOS in both peak hours. Due to the designation of Camino del Rey as an Arterial and other policies of the County, stop control along Camino del Rey may not be acceptable to the County of San Diego.

As described above, all three improvement options for West Lilac Road/Camino Del Rey (e.g., roundabout, signalization, and all-way stop control with an eastbound left-turn lane) would result in satisfactory operations. As shown in Table X, West Lilac Road/Camino Del Rey would operate at satisfactory LOS during both peak hours with each of the identified improvements. Although each improvement is a viable option, roundabout control was identified as the preferred alternative based on coordination with County staff.

#6: Old Highway 395/West Lilac Road

The intersection of Old Highway 395/West Lilac Road is anticipated to exceed LOS standards for the Existing and Existing Plus Project conditions during the a.m. peak hour. The LHR TIA (Chen Ryan Associates 2015) also identified a traffic impact at this intersection. The proposed mitigation for that project included signalization and construction of a left-turn lane at the westbound West Lilac Road approach. Two improvement options were evaluated as a part of this analysis:

- **Option 1 – Roundabout:** Per County guidance, a roundabout was considered as an improvement alternative for this intersection. Old Highway 395/West Lilac Road is located south of Old Highway 395/Dulin Road. The elevation and slope of Old Highway 395 increases southbound from West Lilac Road towards Dulin Road. The grade at this intersection appears to exceed both the grade at Old Highway 395/Dulin Road and the 4 percent grade recommended by the FHWA. Unlike the intersection of Old Highway 395/Dulin Road, the existing lane geometry at this intersection includes two southbound lanes and one eastbound lane, and is a four-legged intersection. A larger roundabout footprint is likely needed to accommodate vehicles traveling in the southbound and eastbound directions. The right-of-way needed to accommodate a roundabout at this intersection would be challenging due to the elevation of Old Highway 395, as well as having to match the grading located at the western and southern portions of the intersection. Due to the physical constraints of this intersection (i.e. roadway grade, intersection slope, and right-of-way acquisition needed), roundabout control is not recommended as an improvement.
- **Option 2 – Signalization:** As previously mentioned, a traffic signal warrant analysis was conducted based on the California (MUTCD) 2014 Edition. The (Warrant 1 – Eight Hour), (Warrant 2 – Four Hour), and (Warrant 3 –Peak Hour) signal warrants were met for the Existing Plus Project condition. The LOS worksheets are provided as Appendix G, and the signal warrant worksheets for this intersection are provided in Appendix H.

As shown on Table X, Old Highway 395/West Lilac Road would operate at satisfactory LOS during both peak hours with the recommended signal. HCM 2010 intersection LOS worksheets for the significantly impacted intersection with a signal are included in Appendix G.

Table X: Existing Plus Project Intersection Significant Impact Mitigation

#	Intersection	Existing		Existing Plus Project		Mitigation	Existing Plus Project With Mitigation		Significant Impact After Mitigation?
		AM (sec/LOS)	PM (sec/LOS)	AM (sec/LOS)	PM (sec/LOS)		AM (sec/LOS)	PM (sec/LOS)	
3	West Lilac Road/Camino Del Rey	48.3 / E	21.1 / C	69.8 / F	31.0 / D	Option 1: Implement roundabout control	9.1 / A	6.9 / A	No
						Option 2: Signalization	21.5 / C	14.8 / B	
						Option 3: Add eastbound left turn; implement AWSC	20.2 / C	18.8 / C	
6	Old Highway 395/West Lilac Road	33.0 / D	17.9 / C	76.1 / F	34.9 / D	Signalization	6.2 / A	4.9 / A	No

¹ In the p.m. peak hour, with mitigation, the project's increment of delay would be less than 2 seconds for congested intersection at LOS E.

AWSC = all-way stop control
 LOS = level of service
 sec = second/seconds
 SR-76 = State Route 76
 SBL = southbound left

Roadway Segments

None of the study area roadway segments would be significantly impacted. Therefore, no mitigation measures would be required under Existing Plus Project conditions.

Two-Lane Highways

None of the study area two-lane highway facilities would be significantly impacted. Therefore, no mitigation measures would be required under Existing Plus Project conditions.

EXISTING PLUS CUMULATIVE PROJECTS PLUS PROJECT IMPACTS AND IMPROVEMENTS

Intersections

This analysis identified cumulative impacts at 12 study intersections. The following intersection improvements are recommended to mitigate the traffic impacts and return the LOS to acceptable levels.

Signalized Intersections

Based on the LOS analyses presented in this TIS, the following signalized intersections are forecast to operate at unsatisfactory LOS F during both peak hours under Existing Plus Cumulative Projects Plus Project conditions. According to the County's significance thresholds, a significant project impact occurs at a congested intersection under the following conditions:

Project adds 2 seconds of delay or less to a signalized intersection operating at LOS E

- Project adds 1 second of delay to, or 5 peak-hour trips or fewer on a critical movement for, a signalized intersection operating at LOS F

In order to identify the project's increment of delay at the deficient signalized intersection under Existing Plus Cumulative Projects Plus Project conditions and determine whether the project results in a significant impact, an Existing Plus Cumulative Projects (No Project) LOS analysis was conducted. The results of this analysis are described below.

#20: I-15 Northbound Ramps/SR-76. In the Existing Plus Cumulative Projects (No Project) condition, this intersection operates at unsatisfactory delay of 138.1 seconds in the p.m. peak hour. With the addition of project traffic, the delay is expected to decrease 0.3 seconds in the p.m. peak hour. According to the County guidelines, a congested intersection at LOS F would create a significant impact, if in the plus project condition, the delay exceeds more than 1 second.

Synchro calculates the average delay by taking into account the delay of all movements and the number of vehicles at an intersection. If adding project traffic to a movement would not increase delay significantly, the overall average delay may go down, as is the case here in the p.m. peak hour.

As the project does not increase delay in the p.m. peak hour of more than 1 second, there is no significant impact.

Fair Share Contribution to SR-76 Corridor Improvements

Based on coordination with County and Caltrans staff, it was determined that a fair share contribution to future SR-76 corridor improvements would mitigate five (5) Caltrans intersections that would be impacted in the Existing Plus Project Plus Cumulative condition. The amount of the fair share contribution shall be based on the Project's percentage of the cumulative peak-hour volumes. It was determined that at the following impacted intersections, the project would contribute the following percentage contributions towards corridor improvements:

- #1: SR-76 /Olive Hill Road-Camino Del Rey – 3.4 percent
- #4: Old Highway 395/SR-76 – 3.8 percent
- #16: SR-76/ Old River Road–E. Vista Way – 2.9 percent
- #17: SR-76 /North River Road – 3.7 percent
- #18: SR-76 /Via Montellano – 3.7 percent

With payment of the fair share contribution to the SR-76 corridor improvements, the five cumulatively impacted Caltrans intersections would be mitigated and would not be impacts.

Unsignalized Intersections

Based on the LOS analyses presented in this TIS, the following two unsignalized intersections are forecast to operate at unsatisfactory LOS F during one or both peak hours under the Existing Plus Cumulative Projects Plus Project conditions. The results of this analysis, as well as the significant impacts and recommended improvements, are described below.

#3 West Lilac Road/Camino Del Rey. The intersection of West Lilac Road/Camino Del Rey is anticipated to exceed LOS standards in the a.m. and p.m. peak hours for the Existing Plus Cumulative Projects Plus Project condition. As previously described, roundabout control was identified as the preferred alternative in the Existing Plus Project condition to mitigate the direct impact and would remain as the preferred alternative in Existing Plus Cumulative Projects Plus Project condition.

As shown in Table Y, West Lilac Road/Camino Del Rey would operate at satisfactory LOS during both peak hours with the identified improvement. HCM 2010 intersection LOS worksheets for the significantly impacted intersection with recommended improvements are included in Appendix G.

#15: Lilac Road/Old Castle Road. The intersection of Lilac Road/Old Castle Road is anticipated to exceed LOS standards in the a.m. peak hour for the Existing Plus Cumulative Projects Plus Project condition. The LHR Technical Addendum (LLG Engineers 2018b) also identified a cumulative traffic impact at this intersection. The proposed mitigation for that project considered signalization or implementation of a roundabout at the intersection.

It is recommended that all-way stop control is implemented at this intersection to allow the intersection to operate at satisfactory LOS.

As shown in Table Y, Lilac Road/Old Castle Road would operate at satisfactory LOS during both peak hours with the recommended improvements. HCM 2010 intersection LOS worksheets for the significantly impacted intersection with all-way stop control are included in Appendix G.

Table Y: Unsignalized Intersection Cumulative Impact Mitigation Summary

#	Intersection	Existing		Existing Plus Cumulative Projects Plus Project		Mitigation	Existing Plus Cumulative Projects Plus Project With Mitigation		Cumulative Impact? (After Mitigation)
		AM (sec/LOS)	PM (sec/LOS)	AM (sec/LOS)	PM (sec/LOS)		AM (sec/LOS)	PM (sec/LOS)	
3	West Lilac Road/Camino Del Rey	48.3 / E	21.1 / C	291.2 / F	174.0 / F	Roundabout	16.4 / B	11.1 / B	No
15	Lilac Road/Old Castle Road	22.1 / C	17.4 / C	72.7 / F	40.9 / E	AWSC	16.6 / C	18.0 / C	No

AWSC = all-way stop control
LOS = level of service
sec = seconds
SR-76 = State Route 76

Fee Programs

The project is subject to Transportation Impact Fee (TIF) payments, which fund future roadway improvements to Bonsall facilities. The TIF program is a fee program specific to unincorporated San Diego County that provides a mechanism whereby County developers can contribute a fee to the program in lieu of mitigating cumulative traffic impacts through physical road construction. The project is also subject to the payment of the SANDAG Regional Transportation Congestion Improvement Program (RTCIP) fee.

LSA looked to the County Department of Public Works to determine if nearby facilities are listed for improvement. The intersection of Old River Road and Camino Del Rey is listed as a Capital Improvement Project (CIP) project. This CIP project seeks to realign this intersection to provide for a signalized three-legged intersection. This project is anticipated to provide relief to the peak-hour queuing that was observed in the vicinity of Bonsall Elementary School.

#6: Old Highway 395/West Lilac Road

The addition of project and cumulative traffic volumes is anticipated to result in an unsatisfactory LOS (LOS F) at this intersection. The LHR TIA (Chen Ryan Associates 2015) also identified a cumulative traffic impact at this intersection. The proposed mitigation for that project included payment into the TIF program. This intersection is a TIF facility, and it is recommended that the project applicant be responsible for making TIF payments. This cumulatively impacted intersection would be mitigated through payment of the TIF fee.

#7: I-15 Southbound Ramps/Old Highway 395

The addition of project and cumulative traffic volumes is anticipated to result in an unsatisfactory LOS (LOS F) at this intersection. The LHR TIA (Chen Ryan Associates 2015) also identified a cumulative traffic impact at this intersection. The proposed mitigation for that project included

payment into the TIF program. This intersection is a TIF facility, and it is recommended that the project applicant be responsible for making TIF payments. This cumulatively impacted intersection would be mitigated through payment of the TIF fee.

#8: I-15 Northbound Ramps/Old Highway 395

The addition of project and cumulative traffic volumes is anticipated to result in an unsatisfactory LOS (LOS F) at this intersection. The LHR TIA (Chen Ryan Associates 2015) also identified a cumulative traffic impact at this intersection. The proposed mitigation for that project included payment into the TIF program. This intersection is a TIF facility, and it is recommended that the project applicant be responsible for making TIF payments. This cumulatively impacted intersection would be mitigated through payment of the TIF fee.

#9: Old Highway 395/Camino Del Rey

The addition of project and cumulative traffic volumes is anticipated to result in an unsatisfactory LOS (LOS F) at this intersection. The LHR TIA (Chen Ryan Associates 2015) also identified a cumulative traffic impact at this intersection. The proposed mitigation for that project included payment into the TIF program. This intersection is a TIF facility, and it is recommended that the project applicant be responsible for making TIF payments. This cumulatively impacted intersection would be mitigated through payment of the TIF fee.

#11: Old Highway 395/Gopher Canyon

The addition of project and cumulative traffic volumes is anticipated to result in an unsatisfactory LOS (LOS F) at this intersection. The LHR TIA (Chen Ryan Associates 2015) also identified a cumulative traffic impact at this intersection. The proposed mitigation for that project included payment into the TIF program. This intersection is a TIF facility, and it is recommended that the project applicant be responsible for making TIF payments. This cumulatively impacted intersection would be mitigated through payment of the TIF fee.

Roadway Segments

This analysis identified three roadway segments potentially impacted by the project and cumulative traffic volumes.

Camino Del Rey (Old River Road to West Lilac Road)

The addition of project and cumulative traffic volumes is anticipated to result in an unsatisfactory LOS (LOS F) on this roadway segment. The Lilac Hills Ranch project TIA (Chen Ryan Associates 2015) also identified a cumulative traffic impact on this roadway segment. This roadway segment is included in the list of facilities included in the County's TIF. The project applicant would be responsible for making TIF payments. This cumulatively impacted roadway segment would be mitigated through payment of the TIF fee.

Old Highway 395 (Circle R Drive to Camino Del Rey)

The addition of project and cumulative traffic volumes is anticipated to result in an unsatisfactory LOS (LOS F) on this roadway segment. This roadway segment is included in the list of facilities

included in the County's TIF. The project applicant would be responsible for making TIF payments. This cumulatively impacted roadway segment would be mitigated through payment of the TIF fee.

Old Highway 395 (Circle R Drive to Gopher Canyon Road)

The addition of project and cumulative traffic volumes is anticipated to result in an unsatisfactory LOS (LOS F) on this roadway segment. This roadway segment is included in the list of facilities included in the County's TIF. The project applicant would be responsible for making TIF payments. This cumulatively impacted roadway segment would be mitigated through payment of the TIF fee.

SUMMARY OF RECOMMENDED IMPROVEMENTS AND PROJECT DESIGN FEATURES

Based on the results of this TIS, the Ocean Breeze Ranch Project can be implemented by resolving the direct impacts at the following intersections with the recommended improvements:

- West Lilac Road/Camino Del Rey—Roundabout Control, Signalization, or All-Way Stop Control with Eastbound Left-Turn Lane
- Old Highway 395/West Lilac Road—Signalization

Cumulative impacts would be resolved through fair share contribution to SR-76 improvements, payment of the TIF fee, and through the following recommended improvements:

- Fair Share Contribution to SR-76 Improvements – Intersections
 - SR-76 /Olive Hill Road-Camino Del Rey – 3.4 percent
 - Old Highway 395/SR-76 – 3.8 percent
 - SR-76/Old River Road–E. Vista Way – 2.9 percent
 - SR-76 /North River Road – 3.7 percent
 - SR-76 /Via Montellano – 3.7 percent
- Intersection Improvements
 - West Lilac Road and Camino Del Rey – Roundabout Control, Signalization, or All-Way Stop Control with Eastbound Left-Turn Lane
 - Lilac Road/Old Castle Road – All-Way Stop Control
- TIF Payment —Intersections
 - Old Highway 395/West Lilac Road
 - I-15 southbound ramps/Old Highway 395
 - I-15 northbound ramps/Old Highway 395
 - Old Highway 395/Camino Del Rey
 - Old Highway 395/Gopher Canyon
- TIF Payment —Roadway Segments
 - Camino Del Rey (Old River Road to West Lilac Road)
 - Old Highway 395 (Circle R Drive to Camino Del Rey)
 - Old Highway 395 (Circle R Drive to Gopher Canyon Road)

Based on the results of a queuing analysis at the two access points along West Lilac Road, the maximum outbound queue at both project intersections is approximately 4 vehicles or 100 ft (25 ft per vehicle). As stated in the *Left-Turn Accommodations at Unsignalized Intersections* (2013) from the NCHRP, a left-turn lane is recommended for a Light Collector roadway segment when there are 50 or more peak-hour vehicles making a left turn. The *Public Road Standards* (2012), Page 14, Section 4.4, C.5, by the County Department of Public Works recommends a minimum left-turn storage length of 200 ft with a 120 ft taper at both project intersections with West Lilac Road.

REFERENCES

California Department of Transportation (Caltrans). 2015. *Highway Design Manual*. Sacramento. June.

_____. 2017a. 2016 Traffic Volumes on California State Highways. Sacramento.

_____. 2017b. *2016 Annual Average Daily Truck Traffic on the California State Highway System*. Compiled by the Division of Traffic Operations, Office of Performance. Sacramento.

Chen Ryan Associates. 2015. Lilac Hills Ranch Traffic Impact Study. July.

County of San Diego. 2010. *General Plan Update Environmental Impact Report*. San Diego. September.

_____. 2011. *Guidelines for Determining Significance and Report Format and Content Requirements Transportation and Traffic*. County of San Diego Department of Planning and Land Use and Department of Public Works. San Diego. August.

_____. 2012. *Public Road Standards*. County of San Diego Department of Public Works.

_____. Revised 2015. *San Diego County General Plan*. San Diego. April.

_____. Revised 2017. TIF Program Fee Rates.

EFS Engineering, Inc. 2012. County of San Diego Transportation Impact Fee Program Update Nexus Study. San Diego. September.

LLG Engineers. 2018a. Newland Sierra Traffic Impact Analysis. March.

_____. 2018b. Technical Addendum to the 2015 Lilac Hills Ranch Traffic Impact Study.

National Cooperative Highway Research Program (NCHRP). 2013. *Left-Turn Accommodations at Unsignalized Intersections*.

San Diego Association of Governments (SANDAG). 2003. (Not So) Brief Guide of Vehicular Traffic Generation Rates for the San Diego Region. San Diego. April.

San Diego Traffic Engineers' Council/Institute of Transportation Engineers (SANTEC/ITE). 2008. *SANTEC/ITE Guidelines for Traffic Impact Studies in the San Diego Region*.

Transportation Research Board (TRB). 2010. *Highway Capacity Manual 2010*.

APPENDIX A

COUNT DATA, 2017 CALTRANS TRAFFIC VOLUMES AND 2016 TRUCK VOLUMES

County of San Diego
 N/S: SR-76
 E/W: Olive Hill Road/Camino Del Rey
 Weather: Clear

File Name : 01_CSD_76_Olive Hill_Cm Del Rey AM
 Site Code : 00318811
 Start Date : 11/8/2018
 Page No : 1

Groups Printed- Total Volume

Start Time	SR-76 Southbound				Camino Del Rey Westbound				SR-76 Northbound				Olive Hill Road Eastbound				Int. Total
	Left	Thru	Right	App. Total	Left	Thru	Right	App. Total	Left	Thru	Right	App. Total	Left	Thru	Right	App. Total	
07:00 AM	84	576	9	669	30	16	33	79	19	237	16	272	11	37	48	96	1116
07:15 AM	138	469	7	614	24	15	51	90	23	211	26	260	33	46	36	115	1079
07:30 AM	184	495	12	691	25	15	53	93	18	250	47	315	23	41	28	92	1191
07:45 AM	137	475	18	630	29	22	73	124	28	292	71	391	29	57	36	122	1267
Total	543	2015	46	2604	108	68	210	386	88	990	160	1238	96	181	148	425	4653
08:00 AM	55	400	7	462	46	21	64	131	24	259	35	318	28	37	41	106	1017
08:15 AM	52	402	13	467	43	29	67	139	33	261	16	310	21	31	28	80	996
08:30 AM	50	430	8	488	27	23	43	93	30	243	25	298	19	32	42	93	972
08:45 AM	41	281	13	335	20	16	37	73	19	199	23	241	18	19	44	81	730
Total	198	1513	41	1752	136	89	211	436	106	962	99	1167	86	119	155	360	3715
Grand Total	741	3528	87	4356	244	157	421	822	194	1952	259	2405	182	300	303	785	8368
Apprch %	17	81	2		29.7	19.1	51.2		8.1	81.2	10.8		23.2	38.2	38.6		
Total %	8.9	42.2	1	52.1	2.9	1.9	5	9.8	2.3	23.3	3.1	28.7	2.2	3.6	3.6	9.4	

Start Time	SR-76 Southbound				Camino Del Rey Westbound				SR-76 Northbound				Olive Hill Road Eastbound				Int. Total
	Left	Thru	Right	App. Total	Left	Thru	Right	App. Total	Left	Thru	Right	App. Total	Left	Thru	Right	App. Total	
Peak Hour Analysis From 07:00 AM to 08:45 AM - Peak 1 of 1																	
Peak Hour for Entire Intersection Begins at 07:00 AM																	
07:00 AM	84	576	9	669	30	16	33	79	19	237	16	272	11	37	48	96	1116
07:15 AM	138	469	7	614	24	15	51	90	23	211	26	260	33	46	36	115	1079
07:30 AM	184	495	12	691	25	15	53	93	18	250	47	315	23	41	28	92	1191
07:45 AM	137	475	18	630	29	22	73	124	28	292	71	391	29	57	36	122	1267
Total Volume	543	2015	46	2604	108	68	210	386	88	990	160	1238	96	181	148	425	4653
% App. Total	20.9	77.4	1.8		28	17.6	54.4		7.1	80	12.9		22.6	42.6	34.8		
PHF	.738	.875	.639	.942	.900	.773	.719	.778	.786	.848	.563	.792	.727	.794	.771	.871	.918

County of San Diego
 N/S: SR-76
 E/W: Olive Hill Road/Camino Del Rey
 Weather: Clear

File Name : 01_CSD_76_Olive Hill_Cm Del Rey AM
 Site Code : 00318811
 Start Date : 11/8/2018
 Page No : 2

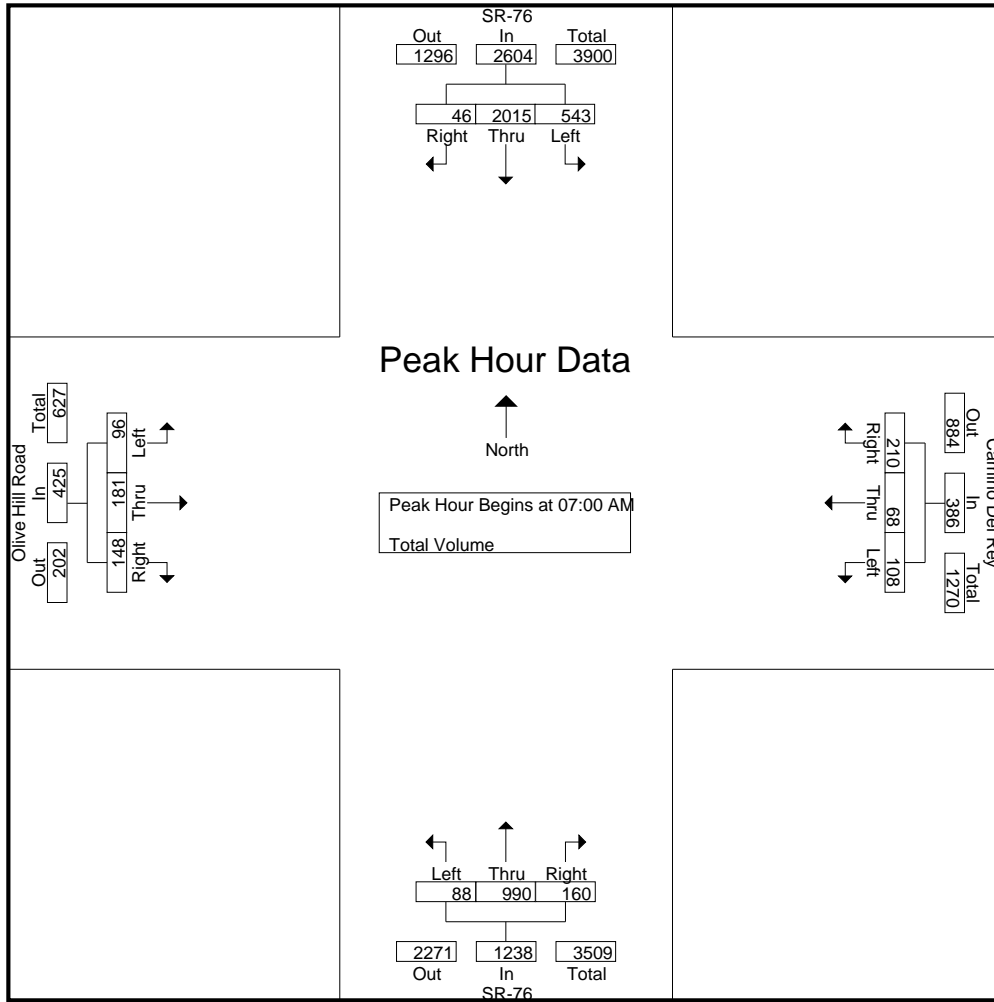

Peak Hour Analysis From 07:00 AM to 08:45 AM - Peak 1 of 1
 Peak Hour for Each Approach Begins at:

	07:00 AM				07:30 AM				07:30 AM				07:15 AM			
+0 mins.	84	576	9	669	25	15	53	93	18	250	47	315	33	46	36	115
+15 mins.	138	469	7	614	29	22	73	124	28	292	71	391	23	41	28	92
+30 mins.	184	495	12	691	46	21	64	131	24	259	35	318	29	57	36	122
+45 mins.	137	475	18	630	43	29	67	139	33	261	16	310	28	37	41	106
Total Volume	543	2015	46	2604	143	87	257	487	103	1062	169	1334	113	181	141	435
% App. Total	20.9	77.4	1.8		29.4	17.9	52.8		7.7	79.6	12.7		26	41.6	32.4	
PHF	.738	.875	.639	.942	.777	.750	.880	.876	.780	.909	.595	.853	.856	.794	.860	.891

County of San Diego
 N/S: SR-76
 E/W: Olive Hill Road/Camino Del Rey
 Weather: Clear

File Name : 01_CSD_76_Olive Hill_Cm Del Rey PM
 Site Code : 00318811
 Start Date : 11/8/2018
 Page No : 1

Groups Printed- Total Volume

Start Time	SR-76 Southbound				Camino Del Rey Westbound				SR-76 Northbound				Olive Hill Road Eastbound				Int. Total
	Left	Thru	Right	App. Total	Left	Thru	Right	App. Total	Left	Thru	Right	App. Total	Left	Thru	Right	App. Total	
04:00 PM	54	320	12	386	24	23	70	117	39	583	38	660	25	13	20	58	1221
04:15 PM	43	310	18	371	32	24	76	132	43	559	29	631	29	17	26	72	1206
04:30 PM	45	325	12	382	25	28	89	142	31	575	39	645	27	16	35	78	1247
04:45 PM	58	332	16	406	42	33	81	156	30	566	28	624	33	12	33	78	1264
Total	200	1287	58	1545	123	108	316	547	143	2283	134	2560	114	58	114	286	4938
05:00 PM	54	329	10	393	40	32	71	143	39	538	40	617	28	23	27	78	1231
05:15 PM	60	336	11	407	28	25	56	109	39	584	32	655	24	9	28	61	1232
05:30 PM	46	219	15	280	24	27	88	139	43	567	31	641	29	20	20	69	1129
05:45 PM	55	281	10	346	29	22	75	126	36	566	36	638	26	14	16	56	1166
Total	215	1165	46	1426	121	106	290	517	157	2255	139	2551	107	66	91	264	4758
Grand Total	415	2452	104	2971	244	214	606	1064	300	4538	273	5111	221	124	205	550	9696
Apprch %	14	82.5	3.5		22.9	20.1	57		5.9	88.8	5.3		40.2	22.5	37.3		
Total %	4.3	25.3	1.1	30.6	2.5	2.2	6.2	11	3.1	46.8	2.8	52.7	2.3	1.3	2.1	5.7	

Start Time	SR-76 Southbound				Camino Del Rey Westbound				SR-76 Northbound				Olive Hill Road Eastbound				Int. Total
	Left	Thru	Right	App. Total	Left	Thru	Right	App. Total	Left	Thru	Right	App. Total	Left	Thru	Right	App. Total	
Peak Hour Analysis From 04:00 PM to 05:45 PM - Peak 1 of 1																	
Peak Hour for Entire Intersection Begins at 04:30 PM																	
04:30 PM	45	325	12	382	25	28	89	142	31	575	39	645	27	16	35	78	1247
04:45 PM	58	332	16	406	42	33	81	156	30	566	28	624	33	12	33	78	1264
05:00 PM	54	329	10	393	40	32	71	143	39	538	40	617	28	23	27	78	1231
05:15 PM	60	336	11	407	28	25	56	109	39	584	32	655	24	9	28	61	1232
Total Volume	217	1322	49	1588	135	118	297	550	139	2263	139	2541	112	60	123	295	4974
% App. Total	13.7	83.2	3.1		24.5	21.5	54		5.5	89.1	5.5		38	20.3	41.7		
PHF	.904	.984	.766	.975	.804	.894	.834	.881	.891	.969	.869	.970	.848	.652	.879	.946	.984

County of San Diego
 N/S: SR-76
 E/W: Olive Hill Road/Camino Del Rey
 Weather: Clear

File Name : 01_CSD_76_Olive Hill_Cm Del Rey PM
 Site Code : 00318811
 Start Date : 11/8/2018
 Page No : 2

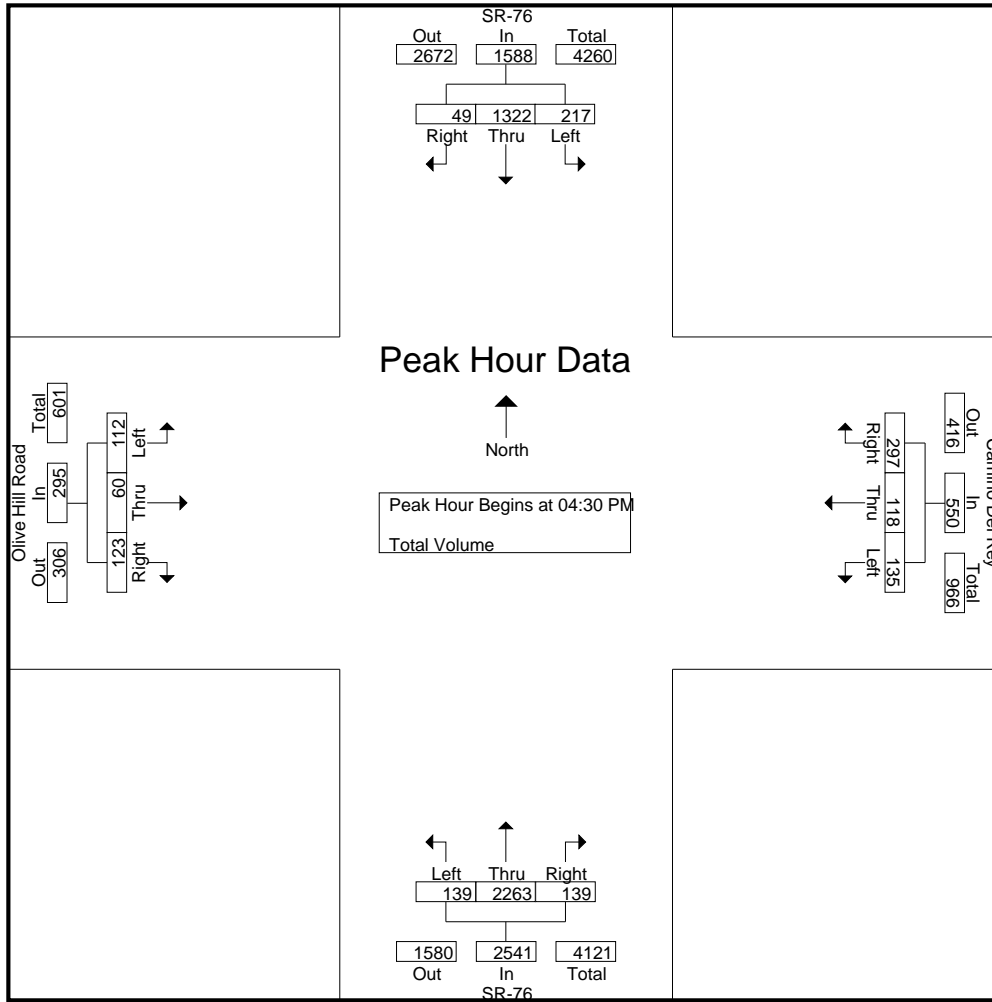

Peak Hour Analysis From 04:00 PM to 05:45 PM - Peak 1 of 1
 Peak Hour for Each Approach Begins at:

	04:30 PM				04:15 PM				04:00 PM				04:15 PM			
+0 mins.	45	325	12	382	32	24	76	132	39	583	38	660	29	17	26	72
+15 mins.	58	332	16	406	25	28	89	142	43	559	29	631	27	16	35	78
+30 mins.	54	329	10	393	42	33	81	156	31	575	39	645	33	12	33	78
+45 mins.	60	336	11	407	40	32	71	143	30	566	28	624	28	23	27	78
Total Volume	217	1322	49	1588	139	117	317	573	143	2283	134	2560	117	68	121	306
% App. Total	13.7	83.2	3.1		24.3	20.4	55.3		5.6	89.2	5.2		38.2	22.2	39.5	
PHF	.904	.984	.766	.975	.827	.886	.890	.918	.831	.979	.859	.970	.886	.739	.864	.981

County of San Diego
 N/S: Camino Del Rey/Old River Road
 E/W: Camino Del Rey
 Weather: Clear

File Name : 02_CSD_Cm Del Rey_Old River AM
 Site Code : 00318811
 Start Date : 11/8/2018
 Page No : 1

Groups Printed- Total Volume

Start Time	Camino Del Rey Southbound			Old River Road Northbound			Camino Del Rey Eastbound			Int. Total
	Thru	Right	App. Total	Left	Thru	App. Total	Left	Right	App. Total	
07:00 AM	33	54	87	13	14	27	75	68	143	257
07:15 AM	29	64	93	22	15	37	105	77	182	312
07:30 AM	21	54	75	47	11	58	178	69	247	380
07:45 AM	21	72	93	52	20	72	219	51	270	435
Total	104	244	348	134	60	194	577	265	842	1384
08:00 AM	15	96	111	38	17	55	109	17	126	292
08:15 AM	19	114	133	14	5	19	70	21	91	243
08:30 AM	12	72	84	9	9	18	95	15	110	212
08:45 AM	13	59	72	12	2	14	61	18	79	165
Total	59	341	400	73	33	106	335	71	406	912
Grand Total	163	585	748	207	93	300	912	336	1248	2296
Apprch %	21.8	78.2		69	31		73.1	26.9		
Total %	7.1	25.5	32.6	9	4.1	13.1	39.7	14.6	54.4	

Start Time	Camino Del Rey Southbound			Old River Road Northbound			Camino Del Rey Eastbound			Int. Total
	Thru	Right	App. Total	Left	Thru	App. Total	Left	Right	App. Total	
07:15 AM	29	64	93	22	15	37	105	77	182	312
07:30 AM	21	54	75	47	11	58	178	69	247	380
07:45 AM	21	72	93	52	20	72	219	51	270	435
08:00 AM	15	96	111	38	17	55	109	17	126	292
Total Volume	86	286	372	159	63	222	611	214	825	1419
% App. Total	23.1	76.9		71.6	28.4		74.1	25.9		
PHF	.741	.745	.838	.764	.788	.771	.697	.695	.764	.816

Peak Hour Analysis From 07:00 AM to 08:45 AM - Peak 1 of 1

Peak Hour for Entire Intersection Begins at 07:15 AM

County of San Diego
 N/S: Camino Del Rey/Old River Road
 E/W: Camino Del Rey
 Weather: Clear

File Name : 02_CSD_Cm Del Rey_Old River AM
 Site Code : 00318811
 Start Date : 11/8/2018
 Page No : 2

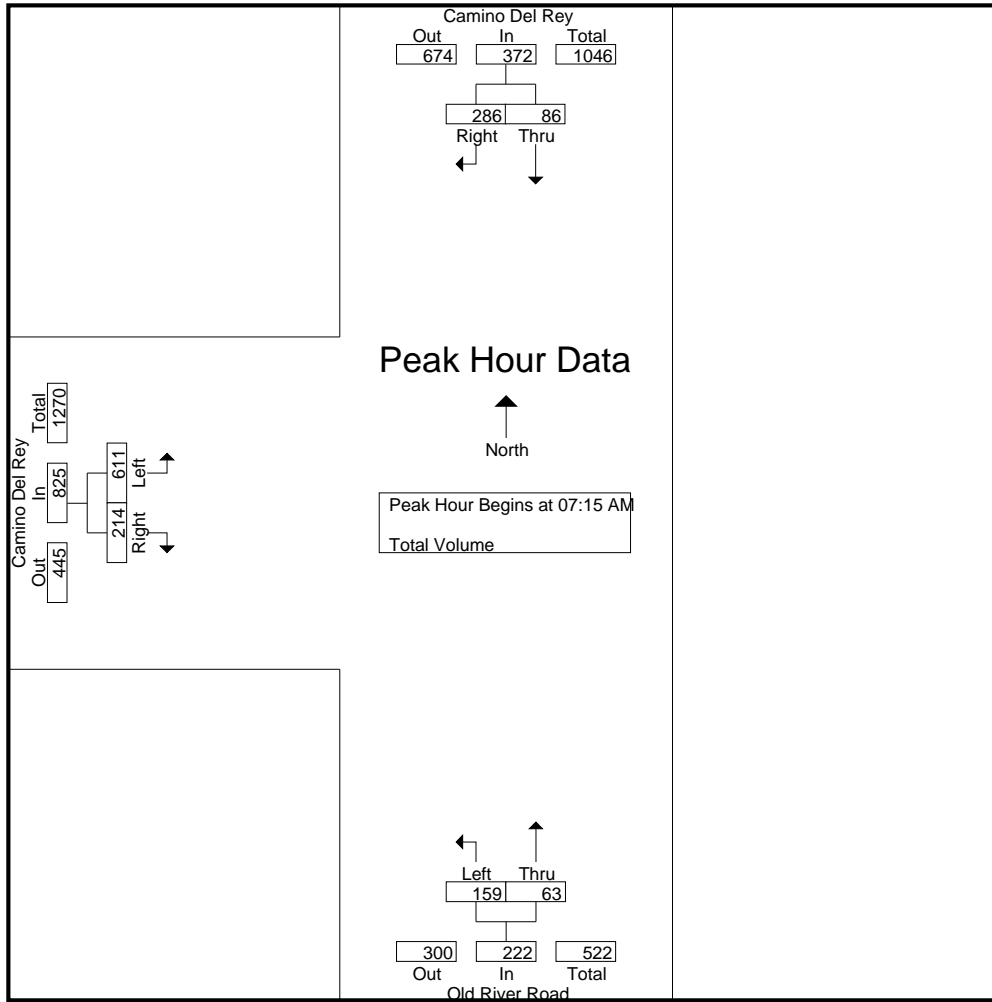

Peak Hour Analysis From 07:00 AM to 08:45 AM - Peak 1 of 1
 Peak Hour for Each Approach Begins at:

	07:45 AM			07:15 AM			07:00 AM		
+0 mins.	21	72	93	22	15	37	75	68	143
+15 mins.	15	96	111	47	11	58	105	77	182
+30 mins.	19	114	133	52	20	72	178	69	247
+45 mins.	12	72	84	38	17	55	219	51	270
Total Volume	67	354	421	159	63	222	577	265	842
% App. Total	15.9	84.1		71.6	28.4		68.5	31.5	
PHF	.798	.776	.791	.764	.788	.771	.659	.860	.780

County of San Diego
 N/S: Camino Del Rey/Old River Road
 E/W: Camino Del Rey
 Weather: Clear

File Name : 02_CSD_Cm Del Rey_Old River PM
 Site Code : 00318811
 Start Date : 11/8/2018
 Page No : 1

Groups Printed- Total Volume

Start Time	Camino Del Rey Southbound			Old River Road Northbound			Camino Del Rey Eastbound			Int. Total
	Thru	Right	App. Total	Left	Thru	App. Total	Left	Right	App. Total	
04:00 PM	11	109	120	25	9	34	98	20	118	272
04:15 PM	11	136	147	14	11	25	74	10	84	256
04:30 PM	20	121	141	26	16	42	85	11	96	279
04:45 PM	6	133	139	23	12	35	69	26	95	269
Total	48	499	547	88	48	136	326	67	393	1076
05:00 PM	16	115	131	24	16	40	86	21	107	278
05:15 PM	11	109	120	19	18	37	80	21	101	258
05:30 PM	10	135	145	15	8	23	83	4	87	255
05:45 PM	11	115	126	15	12	27	97	10	107	260
Total	48	474	522	73	54	127	346	56	402	1051
Grand Total	96	973	1069	161	102	263	672	123	795	2127
Apprch %	9	91		61.2	38.8		84.5	15.5		
Total %	4.5	45.7	50.3	7.6	4.8	12.4	31.6	5.8	37.4	

Start Time	Camino Del Rey Southbound			Old River Road Northbound			Camino Del Rey Eastbound			Int. Total
	Thru	Right	App. Total	Left	Thru	App. Total	Left	Right	App. Total	
04:30 PM	20	121	141	26	16	42	85	11	96	279
04:45 PM	6	133	139	23	12	35	69	26	95	269
05:00 PM	16	115	131	24	16	40	86	21	107	278
05:15 PM	11	109	120	19	18	37	80	21	101	258
Total Volume	53	478	531	92	62	154	320	79	399	1084
% App. Total	10	90		59.7	40.3		80.2	19.8		
PHF	.663	.898	.941	.885	.861	.917	.930	.760	.932	.971

Peak Hour Analysis From 04:00 PM to 05:45 PM - Peak 1 of 1

Peak Hour for Entire Intersection Begins at 04:30 PM

County of San Diego
 N/S: Camino Del Rey/Old River Road
 E/W: Camino Del Rey
 Weather: Clear

File Name : 02_CSD_Cm Del Rey_Old River PM
 Site Code : 00318811
 Start Date : 11/8/2018
 Page No : 2

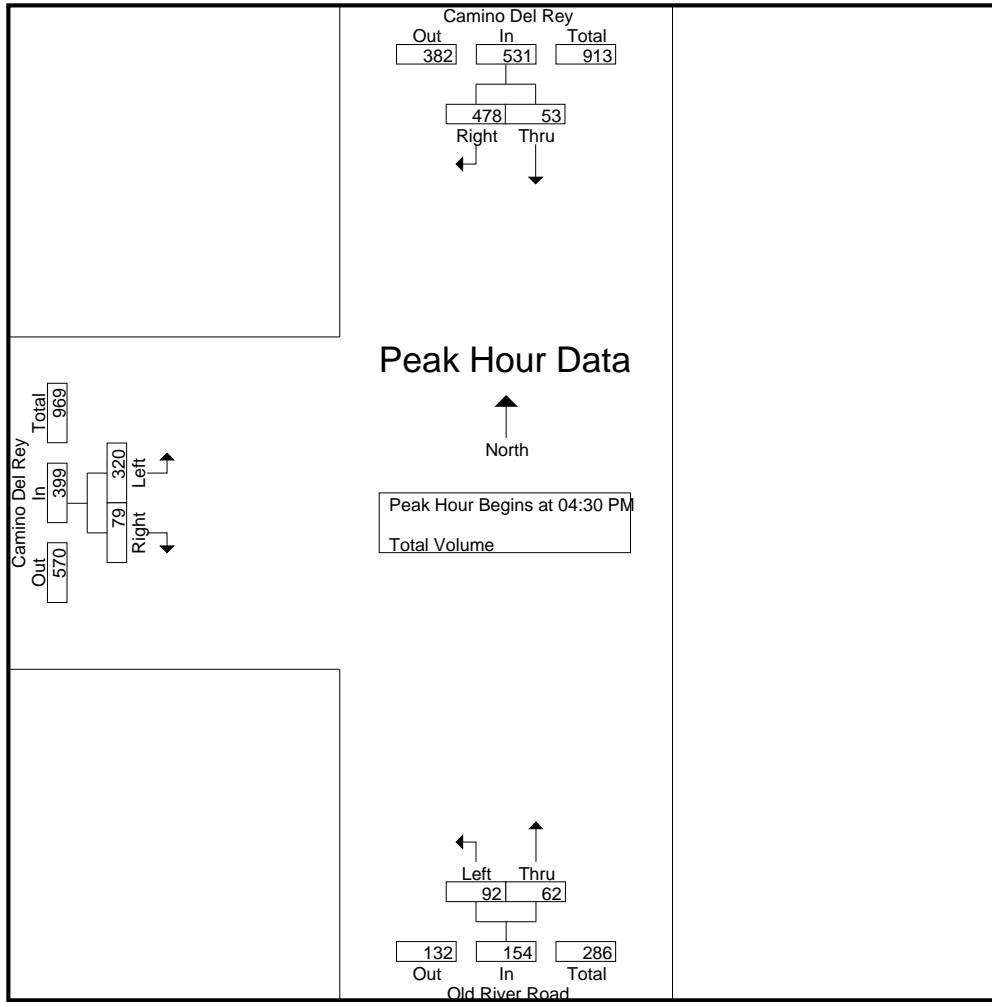

Peak Hour Analysis From 04:00 PM to 05:45 PM - Peak 1 of 1

Peak Hour for Each Approach Begins at:

	04:15 PM			04:30 PM			05:00 PM		
+0 mins.	11	136	147	26	16	42	86	21	107
+15 mins.	20	121	141	23	12	35	80	21	101
+30 mins.	6	133	139	24	16	40	83	4	87
+45 mins.	16	115	131	19	18	37	97	10	107
Total Volume	53	505	558	92	62	154	346	56	402
% App. Total	9.5	90.5		59.7	40.3		86.1	13.9	
PHF	.663	.928	.949	.885	.861	.917	.892	.667	.939

County of San Diego
 N/S: West Lilac Road
 E/W: Camino Del Rey
 Weather: Clear

File Name : 03_CSD_W Lilac_CM Del Rey AM
 Site Code : 00318811
 Start Date : 11/8/2018
 Page No : 1

Groups Printed- Total Volume

Start Time	West Lilac Road Southbound			Camino Del Rey Westbound			Camino Del Rey Eastbound			Int. Total
	Left	Right	App. Total	Thru	Right	App. Total	Left	Thru	App. Total	
07:00 AM	1	21	22	74	4	78	16	66	82	182
07:15 AM	2	35	37	87	2	89	26	77	103	229
07:30 AM	1	40	41	106	3	109	57	117	174	324
07:45 AM	1	35	36	72	5	77	118	99	217	330
Total	5	131	136	339	14	353	217	359	576	1065
08:00 AM	4	56	60	52	8	60	99	81	180	300
08:15 AM	8	67	75	58	3	61	21	51	72	208
08:30 AM	2	40	42	56	4	60	26	76	102	204
08:45 AM	2	21	23	48	0	48	8	52	60	131
Total	16	184	200	214	15	229	154	260	414	843
Grand Total	21	315	336	553	29	582	371	619	990	1908
Apprch %	6.2	93.8		95	5		37.5	62.5		
Total %	1.1	16.5	17.6	29	1.5	30.5	19.4	32.4	51.9	

Start Time	West Lilac Road Southbound			Camino Del Rey Westbound			Camino Del Rey Eastbound			Int. Total
	Left	Right	App. Total	Thru	Right	App. Total	Left	Thru	App. Total	
07:15 AM	2	35	37	87	2	89	26	77	103	229
07:30 AM	1	40	41	106	3	109	57	117	174	324
07:45 AM	1	35	36	72	5	77	118	99	217	330
08:00 AM	4	56	60	52	8	60	99	81	180	300
Total Volume	8	166	174	317	18	335	300	374	674	1183
% App. Total	4.6	95.4		94.6	5.4		44.5	55.5		
PHF	.500	.741	.725	.748	.563	.768	.636	.799	.776	.896

Peak Hour Analysis From 07:00 AM to 08:45 AM - Peak 1 of 1

Peak Hour for Entire Intersection Begins at 07:15 AM

County of San Diego
 N/S: West Lilac Road
 E/W: Camino Del Rey
 Weather: Clear

File Name : 03_CSD_W Lilac_CM Del Rey AM
 Site Code : 00318811
 Start Date : 11/8/2018
 Page No : 2

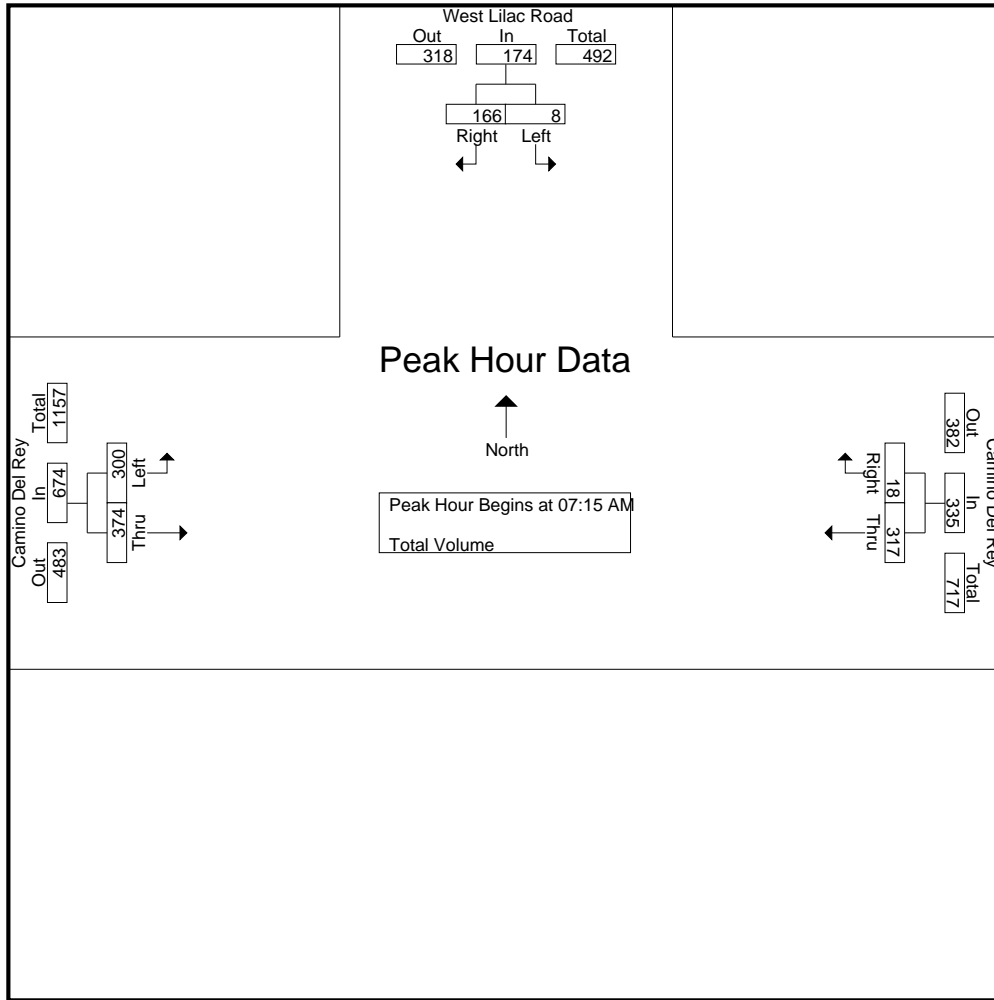

Peak Hour Analysis From 07:00 AM to 08:45 AM - Peak 1 of 1

Peak Hour for Each Approach Begins at:

	07:45 AM			07:00 AM			07:15 AM		
+0 mins.	1	35	36	74	4	78	26	77	103
+15 mins.	4	56	60	87	2	89	57	117	174
+30 mins.	8	67	75	106	3	109	118	99	217
+45 mins.	2	40	42	72	5	77	99	81	180
Total Volume	15	198	213	339	14	353	300	374	674
% App. Total	7	93		96	4		44.5	55.5	
PHF	.469	.739	.710	.800	.700	.810	.636	.799	.776

County of San Diego
 N/S: West Lilac Road
 E/W: Camino Del Rey
 Weather: Clear

File Name : 03_CSD_W Lilac_CM Del Rey PM
 Site Code : 00318811
 Start Date : 11/8/2018
 Page No : 1

Groups Printed- Total Volume

Start Time	West Lilac Road Southbound			Camino Del Rey Westbound			Camino Del Rey Eastbound			Int. Total
	Left	Right	App. Total	Thru	Right	App. Total	Left	Thru	App. Total	
04:00 PM	1	20	21	104	1	105	32	76	108	234
04:15 PM	0	29	29	114	3	117	22	61	83	229
04:30 PM	0	33	33	120	4	124	30	70	100	257
04:45 PM	0	24	24	113	2	115	23	57	80	219
Total	1	106	107	451	10	461	107	264	371	939
05:00 PM	0	22	22	105	1	106	23	77	100	228
05:15 PM	3	19	22	109	1	110	17	80	97	229
05:30 PM	4	40	44	109	2	111	18	70	88	243
05:45 PM	2	35	37	100	0	100	20	71	91	228
Total	9	116	125	423	4	427	78	298	376	928
Grand Total	10	222	232	874	14	888	185	562	747	1867
Apprch %	4.3	95.7		98.4	1.6		24.8	75.2		
Total %	0.5	11.9	12.4	46.8	0.7	47.6	9.9	30.1	40	

Start Time	West Lilac Road Southbound			Camino Del Rey Westbound			Camino Del Rey Eastbound			Int. Total
	Left	Right	App. Total	Thru	Right	App. Total	Left	Thru	App. Total	
04:00 PM	1	20	21	104	1	105	32	76	108	234
04:15 PM	0	29	29	114	3	117	22	61	83	229
04:30 PM	0	33	33	120	4	124	30	70	100	257
04:45 PM	0	24	24	113	2	115	23	57	80	219
Total Volume	1	106	107	451	10	461	107	264	371	939
% App. Total	0.9	99.1		97.8	2.2		28.8	71.2		
PHF	.250	.803	.811	.940	.625	.929	.836	.868	.859	.913

Peak Hour Analysis From 04:00 PM to 05:45 PM - Peak 1 of 1
 Peak Hour for Entire Intersection Begins at 04:00 PM

County of San Diego
 N/S: West Lilac Road
 E/W: Camino Del Rey
 Weather: Clear

File Name : 03_CSD_W Lilac_CM Del Rey PM
 Site Code : 00318811
 Start Date : 11/8/2018
 Page No : 2

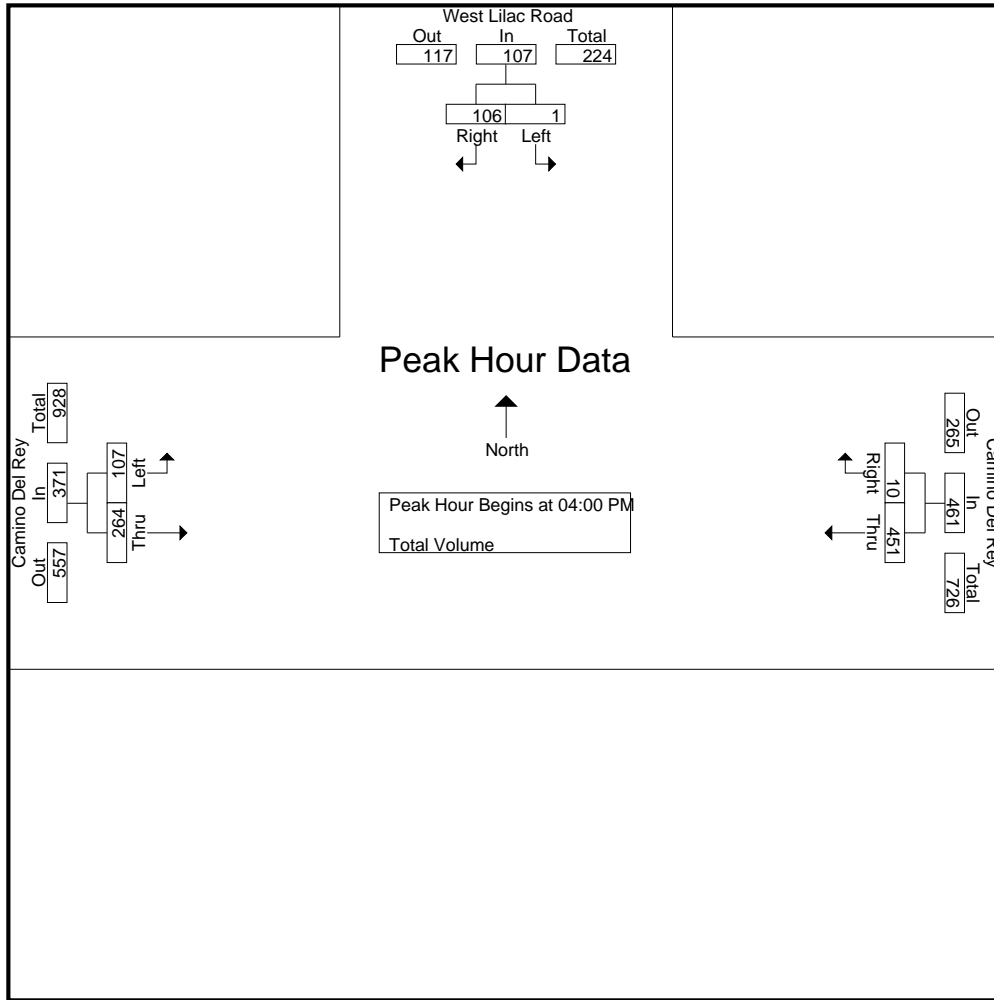

Peak Hour Analysis From 04:00 PM to 05:45 PM - Peak 1 of 1
 Peak Hour for Each Approach Begins at:

	05:00 PM			04:15 PM			04:30 PM		
+0 mins.	0	22	22	114	3	117	30	70	100
+15 mins.	3	19	22	120	4	124	23	57	80
+30 mins.	4	40	44	113	2	115	23	77	100
+45 mins.	2	35	37	105	1	106	17	80	97
Total Volume	9	116	125	452	10	462	93	284	377
% App. Total	7.2	92.8		97.8	2.2		24.7	75.3	
PHF	.563	.725	.710	.942	.625	.931	.775	.888	.943

County of San Diego
 N/S: Old Highway 395
 E/W: SR-76
 Weather: Clear

File Name : 04_CSD_Old Hwy 395_SR-76 AM
 Site Code : 00318811
 Start Date : 11/8/2018
 Page No : 1

Groups Printed- Total Volume

Start Time	Old Highway 395 Southbound				SR-76 Westbound				Old Highway 395 Northbound				SR-76 Eastbound				Int. Total
	Left	Thru	Right	App. Total	Left	Thru	Right	App. Total	Left	Thru	Right	App. Total	Left	Thru	Right	App. Total	
07:00 AM	33	94	35	162	54	224	31	309	39	12	5	56	23	131	35	189	716
07:15 AM	29	106	57	192	55	289	18	362	42	16	10	68	15	156	42	213	835
07:30 AM	37	88	35	160	88	268	18	374	66	23	7	96	11	154	30	195	825
07:45 AM	24	65	20	109	56	283	18	357	23	10	14	47	20	180	43	243	756
Total	123	353	147	623	253	1064	85	1402	170	61	36	267	69	621	150	840	3132
08:00 AM	36	48	42	126	46	258	25	329	28	19	14	61	33	198	39	270	786
08:15 AM	34	45	32	111	60	311	18	389	27	26	16	69	20	197	31	248	817
08:30 AM	46	38	32	116	14	260	26	300	17	16	7	40	19	163	20	202	658
08:45 AM	51	14	27	92	16	233	20	269	28	13	14	55	27	169	17	213	629
Total	167	145	133	445	136	1062	89	1287	100	74	51	225	99	727	107	933	2890
Grand Total	290	498	280	1068	389	2126	174	2689	270	135	87	492	168	1348	257	1773	6022
Apprch %	27.2	46.6	26.2		14.5	79.1	6.5		54.9	27.4	17.7		9.5	76	14.5		
Total %	4.8	8.3	4.6	17.7	6.5	35.3	2.9	44.7	4.5	2.2	1.4	8.2	2.8	22.4	4.3	29.4	

Start Time	Old Highway 395 Southbound				SR-76 Westbound				Old Highway 395 Northbound				SR-76 Eastbound				Int. Total
	Left	Thru	Right	App. Total	Left	Thru	Right	App. Total	Left	Thru	Right	App. Total	Left	Thru	Right	App. Total	
Peak Hour Analysis From 07:00 AM to 08:45 AM - Peak 1 of 1																	
Peak Hour for Entire Intersection Begins at 07:15 AM																	
07:15 AM	29	106	57	192	55	289	18	362	42	16	10	68	15	156	42	213	835
07:30 AM	37	88	35	160	88	268	18	374	66	23	7	96	11	154	30	195	825
07:45 AM	24	65	20	109	56	283	18	357	23	10	14	47	20	180	43	243	756
08:00 AM	36	48	42	126	46	258	25	329	28	19	14	61	33	198	39	270	786
Total Volume	126	307	154	587	245	1098	79	1422	159	68	45	272	79	688	154	921	3202
% App. Total	21.5	52.3	26.2		17.2	77.2	5.6		58.5	25	16.5		8.6	74.7	16.7		
PHF	.851	.724	.675	.764	.696	.950	.790	.951	.602	.739	.804	.708	.598	.869	.895	.853	.959

County of San Diego
 N/S: Old Highway 395
 E/W: SR-76
 Weather: Clear

File Name : 04_CSD_Old Hwy 395_SR-76 AM
 Site Code : 00318811
 Start Date : 11/8/2018
 Page No : 2

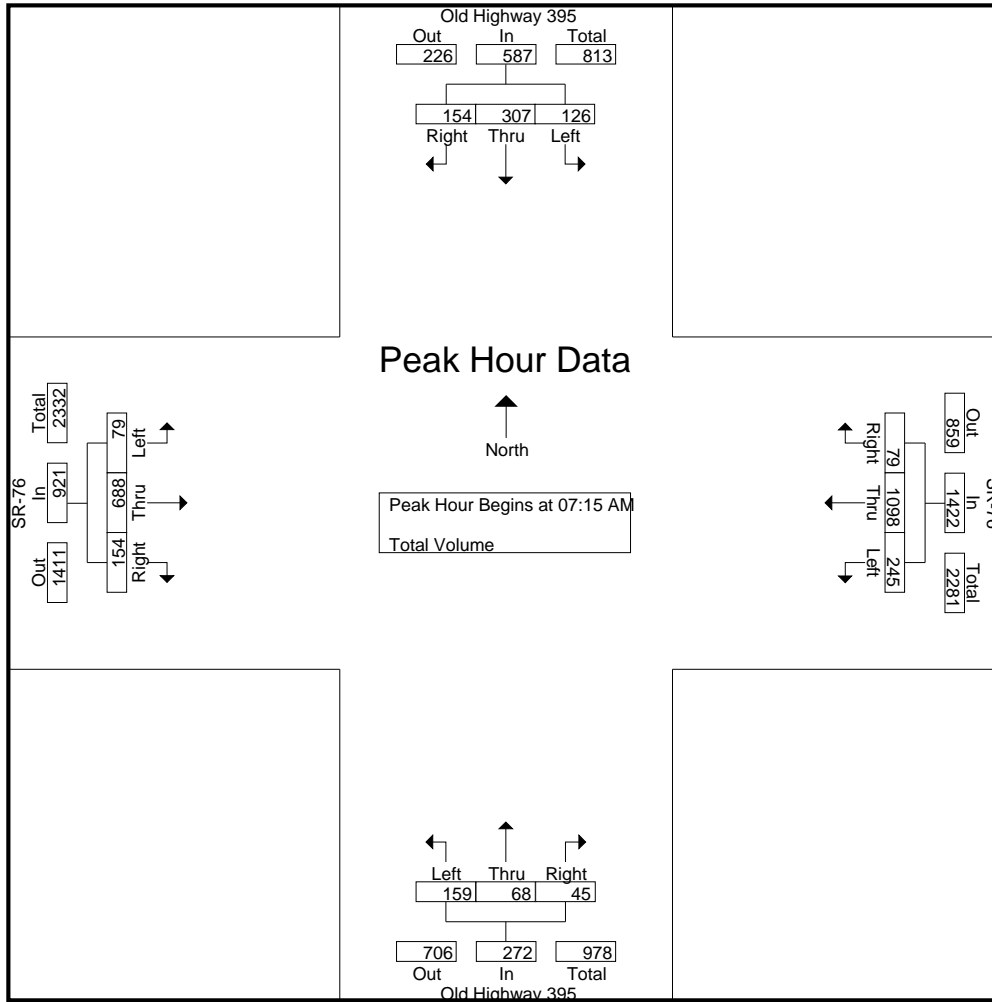

Peak Hour Analysis From 07:00 AM to 08:45 AM - Peak 1 of 1
 Peak Hour for Each Approach Begins at:

	07:00 AM				07:30 AM				07:30 AM				07:45 AM			
+0 mins.	33	94	35	162	88	268	18	374	66	23	7	96	20	180	43	243
+15 mins.	29	106	57	192	56	283	18	357	23	10	14	47	33	198	39	270
+30 mins.	37	88	35	160	46	258	25	329	28	19	14	61	20	197	31	248
+45 mins.	24	65	20	109	60	311	18	389	27	26	16	69	19	163	20	202
Total Volume	123	353	147	623	250	1120	79	1449	144	78	51	273	92	738	133	963
% App. Total	19.7	56.7	23.6		17.3	77.3	5.5		52.7	28.6	18.7		9.6	76.6	13.8	
PHF	.831	.833	.645	.811	.710	.900	.790	.931	.545	.750	.797	.711	.697	.932	.773	.892

County of San Diego
 N/S: Old Highway 395
 E/W: SR-76
 Weather: Clear

File Name : 04_CSD_Old Hwy 395_SR-76 PM
 Site Code : 00318811
 Start Date : 11/8/2018
 Page No : 1

Groups Printed- Total Volume

Start Time	Old Highway 395 Southbound				SR-76 Westbound				Old Highway 395 Northbound				SR-76 Eastbound				Int. Total
	Left	Thru	Right	App. Total	Left	Thru	Right	App. Total	Left	Thru	Right	App. Total	Left	Thru	Right	App. Total	
04:00 PM	75	18	19	112	10	236	41	287	27	52	21	100	33	270	28	331	830
04:15 PM	51	22	21	94	14	204	66	284	25	37	8	70	49	297	39	385	833
04:30 PM	29	18	14	61	6	209	62	277	34	37	14	85	37	253	19	309	732
04:45 PM	36	13	8	57	8	219	60	287	27	34	7	68	36	257	27	320	732
Total	191	71	62	324	38	868	229	1135	113	160	50	323	155	1077	113	1345	3127
05:00 PM	26	17	9	52	8	212	85	305	29	41	6	76	52	238	30	320	753
05:15 PM	46	15	23	84	14	188	64	266	17	40	8	65	57	243	24	324	739
05:30 PM	31	12	22	65	13	218	72	303	20	41	7	68	41	252	25	318	754
05:45 PM	32	19	24	75	10	177	61	248	28	25	6	59	65	261	30	356	738
Total	135	63	78	276	45	795	282	1122	94	147	27	268	215	994	109	1318	2984
Grand Total	326	134	140	600	83	1663	511	2257	207	307	77	591	370	2071	222	2663	6111
Apprch %	54.3	22.3	23.3		3.7	73.7	22.6		35	51.9	13		13.9	77.8	8.3		
Total %	5.3	2.2	2.3	9.8	1.4	27.2	8.4	36.9	3.4	5	1.3	9.7	6.1	33.9	3.6	43.6	

Start Time	Old Highway 395 Southbound				SR-76 Westbound				Old Highway 395 Northbound				SR-76 Eastbound				Int. Total
	Left	Thru	Right	App. Total	Left	Thru	Right	App. Total	Left	Thru	Right	App. Total	Left	Thru	Right	App. Total	
Peak Hour Analysis From 04:00 PM to 05:45 PM - Peak 1 of 1																	
Peak Hour for Entire Intersection Begins at 04:00 PM																	
04:00 PM	75	18	19	112	10	236	41	287	27	52	21	100	33	270	28	331	830
04:15 PM	51	22	21	94	14	204	66	284	25	37	8	70	49	297	39	385	833
04:30 PM	29	18	14	61	6	209	62	277	34	37	14	85	37	253	19	309	732
04:45 PM	36	13	8	57	8	219	60	287	27	34	7	68	36	257	27	320	732
Total Volume	191	71	62	324	38	868	229	1135	113	160	50	323	155	1077	113	1345	3127
% App. Total	59	21.9	19.1		3.3	76.5	20.2		35	49.5	15.5		11.5	80.1	8.4		
PHF	.637	.807	.738	.723	.679	.919	.867	.989	.831	.769	.595	.808	.791	.907	.724	.873	.938

County of San Diego
 N/S: Old Highway 395
 E/W: SR-76
 Weather: Clear

File Name : 04_CSD_Old Hwy 395_SR-76 PM
 Site Code : 00318811
 Start Date : 11/8/2018
 Page No : 2

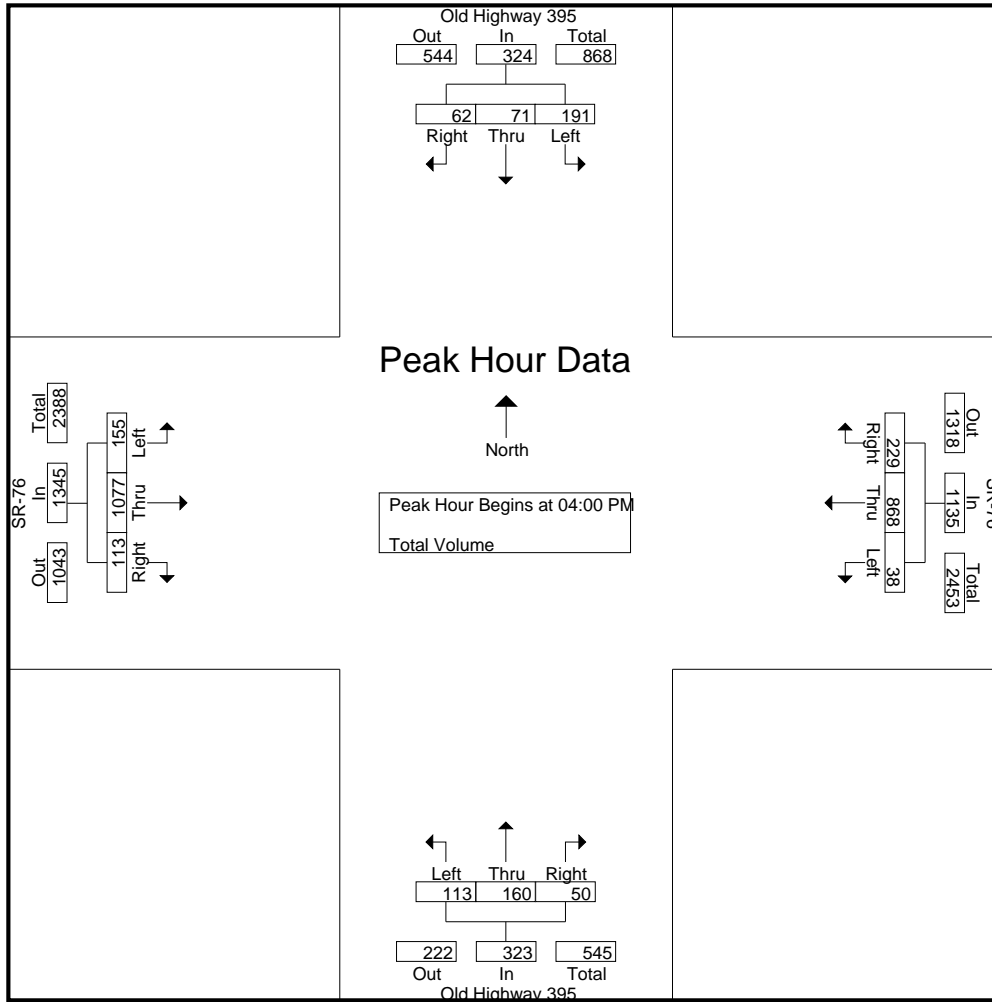

Peak Hour Analysis From 04:00 PM to 05:45 PM - Peak 1 of 1
 Peak Hour for Each Approach Begins at:

	04:00 PM				04:45 PM				04:00 PM				04:00 PM			
+0 mins.	75	18	19	112	8	219	60	287	27	52	21	100	33	270	28	331
+15 mins.	51	22	21	94	8	212	85	305	25	37	8	70	49	297	39	385
+30 mins.	29	18	14	61	14	188	64	266	34	37	14	85	37	253	19	309
+45 mins.	36	13	8	57	13	218	72	303	27	34	7	68	36	257	27	320
Total Volume	191	71	62	324	43	837	281	1161	113	160	50	323	155	1077	113	1345
% App. Total	59	21.9	19.1		3.7	72.1	24.2		35	49.5	15.5		11.5	80.1	8.4	
PHF	.637	.807	.738	.723	.768	.955	.826	.952	.831	.769	.595	.808	.791	.907	.724	.873

County of San Diego
 N/S: Old Highway 395
 E/W: Dulin Road
 Weather: Clear

File Name : 05_CSD_Old Hwy 395_Dulin AM
 Site Code : 00318811
 Start Date : 11/8/2018
 Page No : 1

Groups Printed- Total Volume

Start Time	Old Highway 395 Southbound			Dulin Road Westbound			Old Highway 395 Northbound			Int. Total
	Left	Thru	App. Total	Left	Right	App. Total	Thru	Right	App. Total	
07:00 AM	6	160	166	49	39	88	16	0	16	270
07:15 AM	6	185	191	53	52	105	22	1	23	319
07:30 AM	10	181	191	39	62	101	26	14	40	332
07:45 AM	17	128	145	31	19	50	26	25	51	246
Total	39	654	693	172	172	344	90	40	130	1167
08:00 AM	16	99	115	27	16	43	56	27	83	241
08:15 AM	14	122	136	29	17	46	47	21	68	250
08:30 AM	9	64	73	26	15	41	29	13	42	156
08:45 AM	7	37	44	13	17	30	27	11	38	112
Total	46	322	368	95	65	160	159	72	231	759
Grand Total	85	976	1061	267	237	504	249	112	361	1926
Apprch %	8	92		53	47		69	31		
Total %	4.4	50.7	55.1	13.9	12.3	26.2	12.9	5.8	18.7	

Start Time	Old Highway 395 Southbound			Dulin Road Westbound			Old Highway 395 Northbound			Int. Total
	Left	Thru	App. Total	Left	Right	App. Total	Thru	Right	App. Total	
07:00 AM	6	160	166	49	39	88	16	0	16	270
07:15 AM	6	185	191	53	52	105	22	1	23	319
07:30 AM	10	181	191	39	62	101	26	14	40	332
07:45 AM	17	128	145	31	19	50	26	25	51	246
Total Volume	39	654	693	172	172	344	90	40	130	1167
% App. Total	5.6	94.4		50	50		69.2	30.8		
PHF	.574	.884	.907	.811	.694	.819	.865	.400	.637	.879

Peak Hour Analysis From 07:00 AM to 08:45 AM - Peak 1 of 1

Peak Hour for Entire Intersection Begins at 07:00 AM

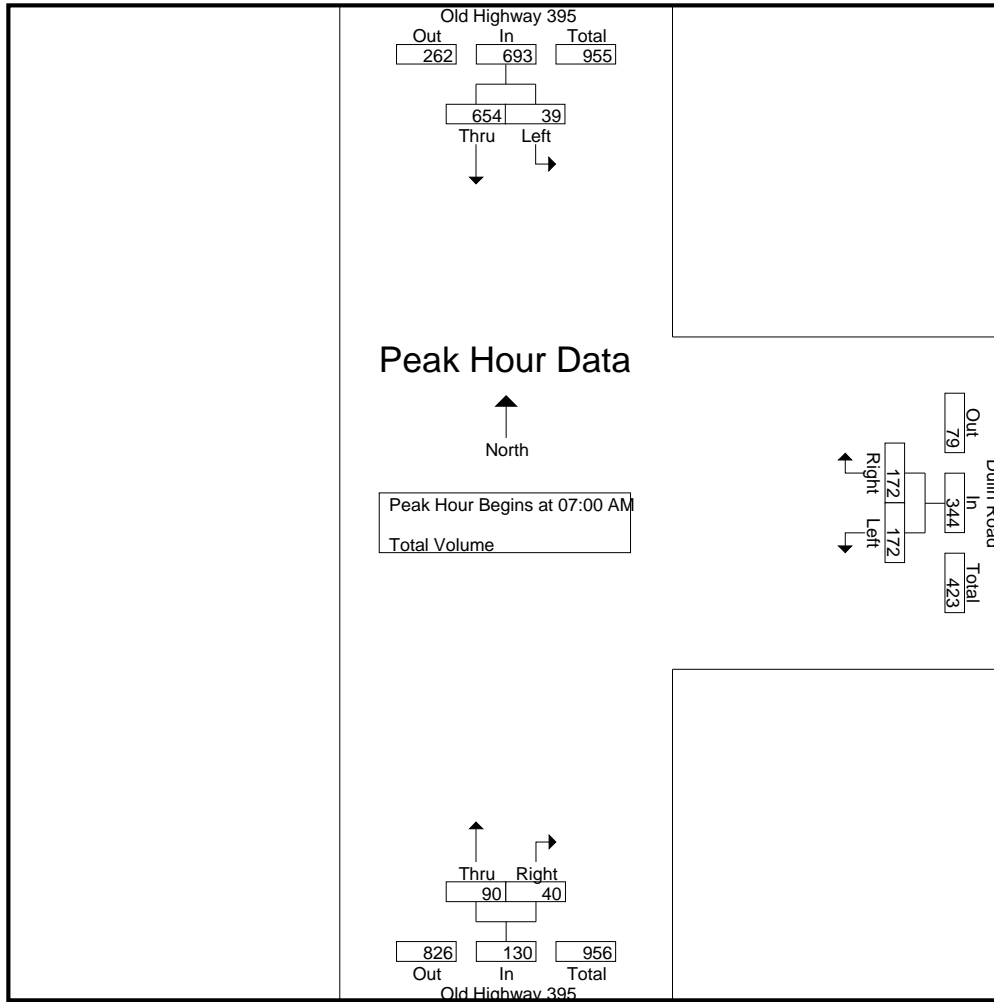

Peak Hour Analysis From 07:00 AM to 08:45 AM - Peak 1 of 1

Peak Hour for Each Approach Begins at:

	07:00 AM			07:00 AM			07:45 AM		
+0 mins.	6	160	166	49	39	88	26	25	51
+15 mins.	6	185	191	53	52	105	56	27	83
+30 mins.	10	181	191	39	62	101	47	21	68
+45 mins.	17	128	145	31	19	50	29	13	42
Total Volume	39	654	693	172	172	344	158	86	244
% App. Total	5.6	94.4		50	50		64.8	35.2	
PHF	.574	.884	.907	.811	.694	.819	.705	.796	.735

County of San Diego
 N/S: Old Highway 395
 E/W: Dulin Road
 Weather: Clear

File Name : 05_CSD_Old Hwy 395_Dulin PM
 Site Code : 00318811
 Start Date : 11/8/2018
 Page No : 1

Groups Printed- Total Volume

Start Time	Old Highway 395 Southbound			Dulin Road Westbound			Old Highway 395 Northbound			Int. Total
	Left	Thru	App. Total	Left	Right	App. Total	Thru	Right	App. Total	
04:00 PM	19	32	51	7	14	21	67	32	99	171
04:15 PM	33	41	74	3	14	17	38	25	63	154
04:30 PM	29	20	49	13	16	29	68	26	94	172
04:45 PM	25	23	48	7	17	24	58	23	81	153
Total	106	116	222	30	61	91	231	106	337	650
05:00 PM	26	27	53	8	13	21	60	32	92	166
05:15 PM	32	21	53	6	10	16	44	40	84	153
05:30 PM	26	26	52	8	21	29	53	31	84	165
05:45 PM	29	25	54	7	15	22	39	30	69	145
Total	113	99	212	29	59	88	196	133	329	629
Grand Total	219	215	434	59	120	179	427	239	666	1279
Apprch %	50.5	49.5		33	67		64.1	35.9		
Total %	17.1	16.8	33.9	4.6	9.4	14	33.4	18.7	52.1	

Start Time	Old Highway 395 Southbound			Dulin Road Westbound			Old Highway 395 Northbound			Int. Total
	Left	Thru	App. Total	Left	Right	App. Total	Thru	Right	App. Total	
04:00 PM	19	32	51	7	14	21	67	32	99	171
04:15 PM	33	41	74	3	14	17	38	25	63	154
04:30 PM	29	20	49	13	16	29	68	26	94	172
04:45 PM	25	23	48	7	17	24	58	23	81	153
Total Volume	106	116	222	30	61	91	231	106	337	650
% App. Total	47.7	52.3		33	67		68.5	31.5		
PHF	.803	.707	.750	.577	.897	.784	.849	.828	.851	.945

Peak Hour Analysis From 04:00 PM to 05:45 PM - Peak 1 of 1

Peak Hour for Entire Intersection Begins at 04:00 PM

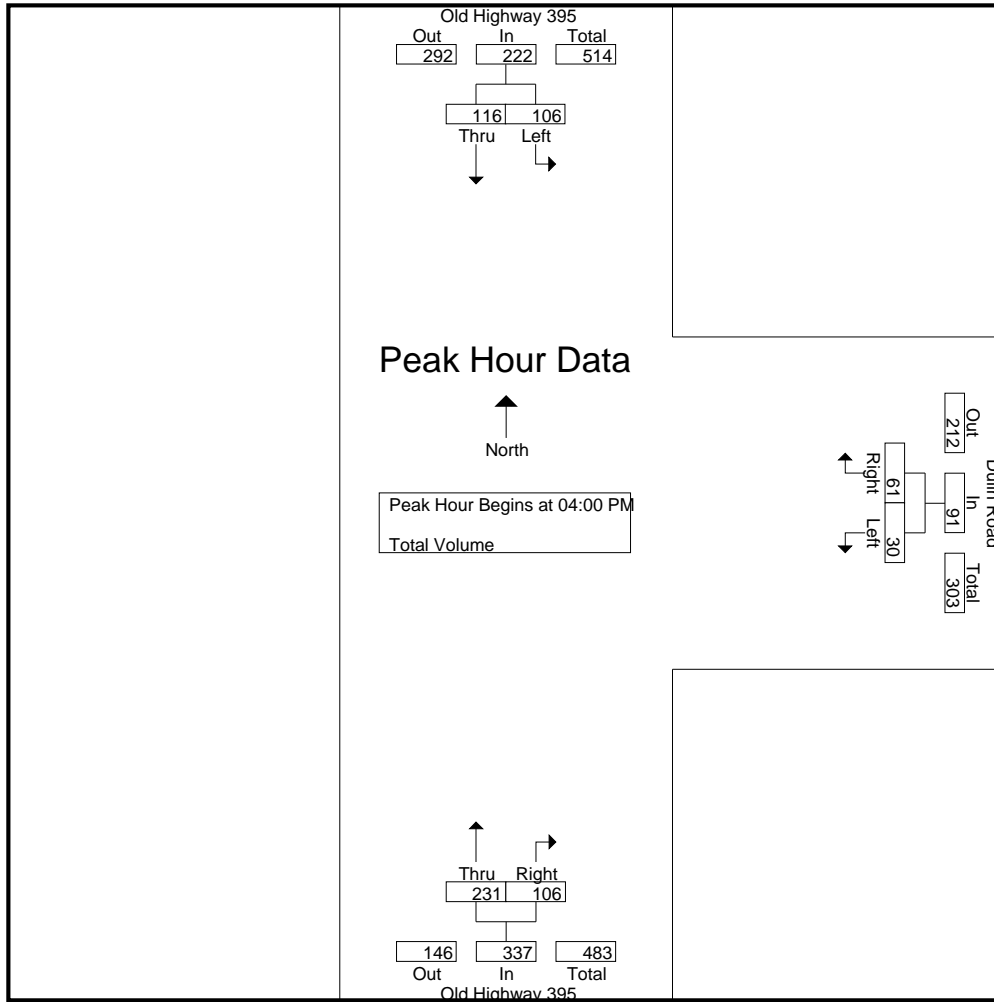

Peak Hour Analysis From 04:00 PM to 05:45 PM - Peak 1 of 1

Peak Hour for Each Approach Begins at:

	04:15 PM			04:00 PM			04:30 PM		
+0 mins.	33	41	74	7	14	21	68	26	94
+15 mins.	29	20	49	3	14	17	58	23	81
+30 mins.	25	23	48	13	16	29	60	32	92
+45 mins.	26	27	53	7	17	24	44	40	84
Total Volume	113	111	224	30	61	91	230	121	351
% App. Total	50.4	49.6		33	67		65.5	34.5	
PHF	.856	.677	.757	.577	.897	.784	.846	.756	.934

County of San Diego
 N/S: Old Highway 395
 E/W: West Lilac Road
 Weather: Clear

File Name : 06_CSD_Old Hwy 395_W Lilac AM
 Site Code : 00318811
 Start Date : 11/8/2018
 Page No : 1

Groups Printed- Total Volume

Start Time	Old Highway 395 Southbound				West Lilac Road Westbound				Old Highway 395 Northbound				West Lilac Road Eastbound				Int. Total
	Left	Thru	Right	App. Total	Left	Thru	Right	App. Total	Left	Thru	Right	App. Total	Left	Thru	Right	App. Total	
07:00 AM	2	163	11	176	9	7	6	22	12	10	2	24	5	1	10	16	238
07:15 AM	3	193	30	226	2	5	3	10	7	7	0	14	12	0	8	20	270
07:30 AM	10	150	26	186	5	7	5	17	14	14	2	30	22	0	12	34	267
07:45 AM	2	80	33	115	8	3	1	12	26	9	4	39	41	6	34	81	247
Total	17	586	100	703	24	22	15	61	59	40	8	107	80	7	64	151	1022
08:00 AM	2	41	30	73	5	2	3	10	21	11	5	37	53	4	30	87	207
08:15 AM	5	73	52	130	6	2	6	14	17	13	4	34	43	5	23	71	249
08:30 AM	5	41	27	73	11	5	4	20	14	13	0	27	15	1	18	34	154
08:45 AM	1	31	12	44	5	1	5	11	8	13	6	27	12	2	5	19	101
Total	13	186	121	320	27	10	18	55	60	50	15	125	123	12	76	211	711
Grand Total	30	772	221	1023	51	32	33	116	119	90	23	232	203	19	140	362	1733
Apprch %	2.9	75.5	21.6		44	27.6	28.4		51.3	38.8	9.9		56.1	5.2	38.7		
Total %	1.7	44.5	12.8	59	2.9	1.8	1.9	6.7	6.9	5.2	1.3	13.4	11.7	1.1	8.1	20.9	

Start Time	Old Highway 395 Southbound				West Lilac Road Westbound				Old Highway 395 Northbound				West Lilac Road Eastbound				Int. Total
	Left	Thru	Right	App. Total	Left	Thru	Right	App. Total	Left	Thru	Right	App. Total	Left	Thru	Right	App. Total	
Peak Hour Analysis From 07:00 AM to 08:45 AM - Peak 1 of 1																	
Peak Hour for Entire Intersection Begins at 07:00 AM																	
07:00 AM	2	163	11	176	9	7	6	22	12	10	2	24	5	1	10	16	238
07:15 AM	3	193	30	226	2	5	3	10	7	7	0	14	12	0	8	20	270
07:30 AM	10	150	26	186	5	7	5	17	14	14	2	30	22	0	12	34	267
07:45 AM	2	80	33	115	8	3	1	12	26	9	4	39	41	6	34	81	247
Total Volume	17	586	100	703	24	22	15	61	59	40	8	107	80	7	64	151	1022
% App. Total	2.4	83.4	14.2		39.3	36.1	24.6		55.1	37.4	7.5		53	4.6	42.4		
PHF	.425	.759	.758	.778	.667	.786	.625	.693	.567	.714	.500	.686	.488	.292	.471	.466	.946

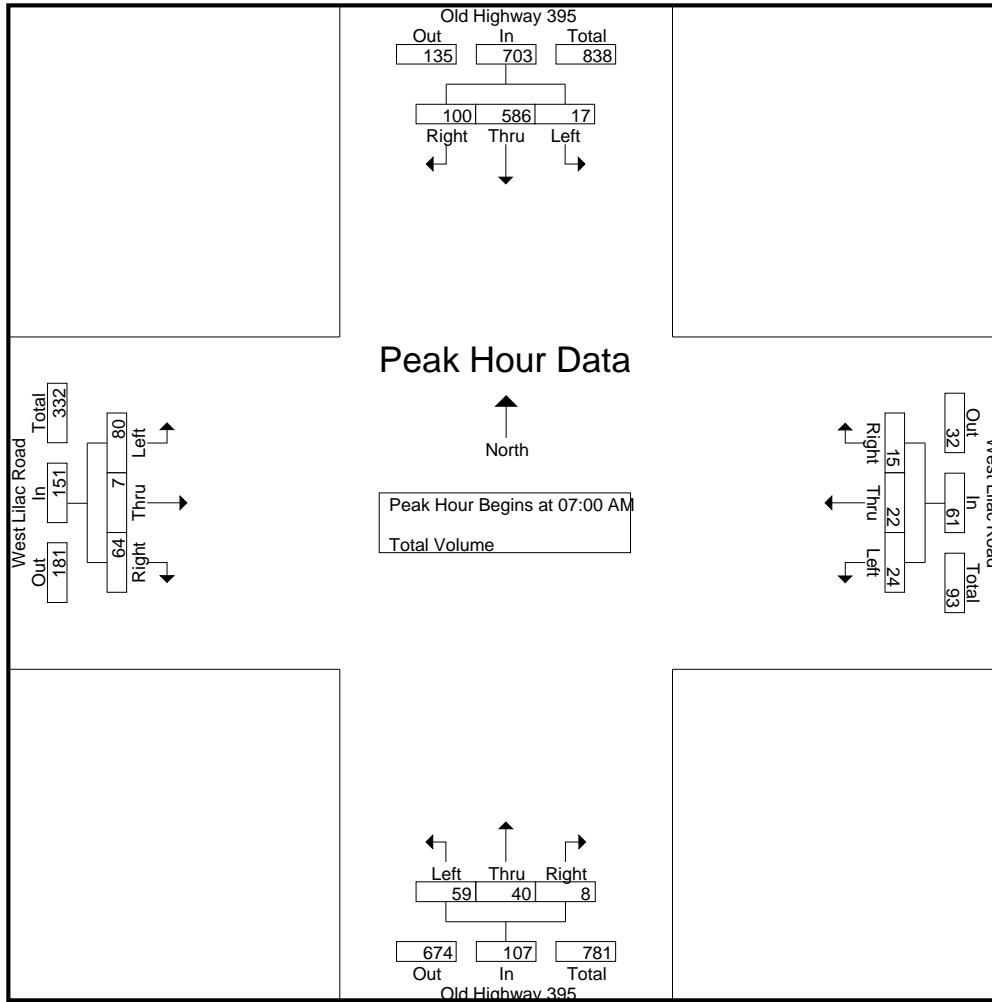

Peak Hour Analysis From 07:00 AM to 08:45 AM - Peak 1 of 1
 Peak Hour for Each Approach Begins at:

	07:00 AM				07:30 AM				07:30 AM							
+0 mins.	2	163	11	176	9	7	6	22	14	14	2	30	22	0	12	34
+15 mins.	3	193	30	226	2	5	3	10	26	9	4	39	41	6	34	81
+30 mins.	10	150	26	186	5	7	5	17	21	11	5	37	53	4	30	87
+45 mins.	2	80	33	115	8	3	1	12	17	13	4	34	43	5	23	71
Total Volume	17	586	100	703	24	22	15	61	78	47	15	140	159	15	99	273
% App. Total	2.4	83.4	14.2		39.3	36.1	24.6		55.7	33.6	10.7		58.2	5.5	36.3	
PHF	.425	.759	.758	.778	.667	.786	.625	.693	.750	.839	.750	.897	.750	.625	.728	.784

County of San Diego
 N/S: Old Highway 395
 E/W: West Lilac Road
 Weather: Clear

File Name : 06_CSD_Old Hwy 395_W Lilac PM
 Site Code : 00318811
 Start Date : 11/8/2018
 Page No : 1

Groups Printed- Total Volume

Start Time	Old Highway 395 Southbound				West Lilac Road Westbound				Old Highway 395 Northbound				West Lilac Road Eastbound				Int. Total
	Left	Thru	Right	App. Total	Left	Thru	Right	App. Total	Left	Thru	Right	App. Total	Left	Thru	Right	App. Total	
04:00 PM	9	23	3	35	5	0	6	11	14	60	7	81	12	4	8	24	151
04:15 PM	7	24	5	36	5	3	10	18	12	65	11	88	9	0	12	21	163
04:30 PM	4	28	8	40	3	2	6	11	19	85	10	114	8	1	10	19	184
04:45 PM	2	26	8	36	1	1	7	9	11	59	6	76	7	5	2	14	135
Total	22	101	24	147	14	6	29	49	56	269	34	359	36	10	32	78	633
05:00 PM	5	22	7	34	9	1	8	18	16	43	11	70	11	2	5	18	140
05:15 PM	10	23	10	43	1	1	8	10	13	61	9	83	8	3	7	18	154
05:30 PM	2	13	5	20	6	1	5	12	8	60	7	75	15	2	8	25	132
05:45 PM	4	11	6	21	2	3	4	9	14	55	5	74	12	0	5	17	121
Total	21	69	28	118	18	6	25	49	51	219	32	302	46	7	25	78	547
Grand Total	43	170	52	265	32	12	54	98	107	488	66	661	82	17	57	156	1180
Apprch %	16.2	64.2	19.6		32.7	12.2	55.1		16.2	73.8	10		52.6	10.9	36.5		
Total %	3.6	14.4	4.4	22.5	2.7	1	4.6	8.3	9.1	41.4	5.6	56	6.9	1.4	4.8	13.2	

Start Time	Old Highway 395 Southbound				West Lilac Road Westbound				Old Highway 395 Northbound				West Lilac Road Eastbound				Int. Total
	Left	Thru	Right	App. Total	Left	Thru	Right	App. Total	Left	Thru	Right	App. Total	Left	Thru	Right	App. Total	
Peak Hour Analysis From 04:00 PM to 05:45 PM - Peak 1 of 1																	
Peak Hour for Entire Intersection Begins at 04:00 PM																	
04:00 PM	9	23	3	35	5	0	6	11	14	60	7	81	12	4	8	24	151
04:15 PM	7	24	5	36	5	3	10	18	12	65	11	88	9	0	12	21	163
04:30 PM	4	28	8	40	3	2	6	11	19	85	10	114	8	1	10	19	184
04:45 PM	2	26	8	36	1	1	7	9	11	59	6	76	7	5	2	14	135
Total Volume	22	101	24	147	14	6	29	49	56	269	34	359	36	10	32	78	633
% App. Total	15	68.7	16.3		28.6	12.2	59.2		15.6	74.9	9.5		46.2	12.8	41		
PHF	.611	.902	.750	.919	.700	.500	.725	.681	.737	.791	.773	.787	.750	.500	.667	.813	.860

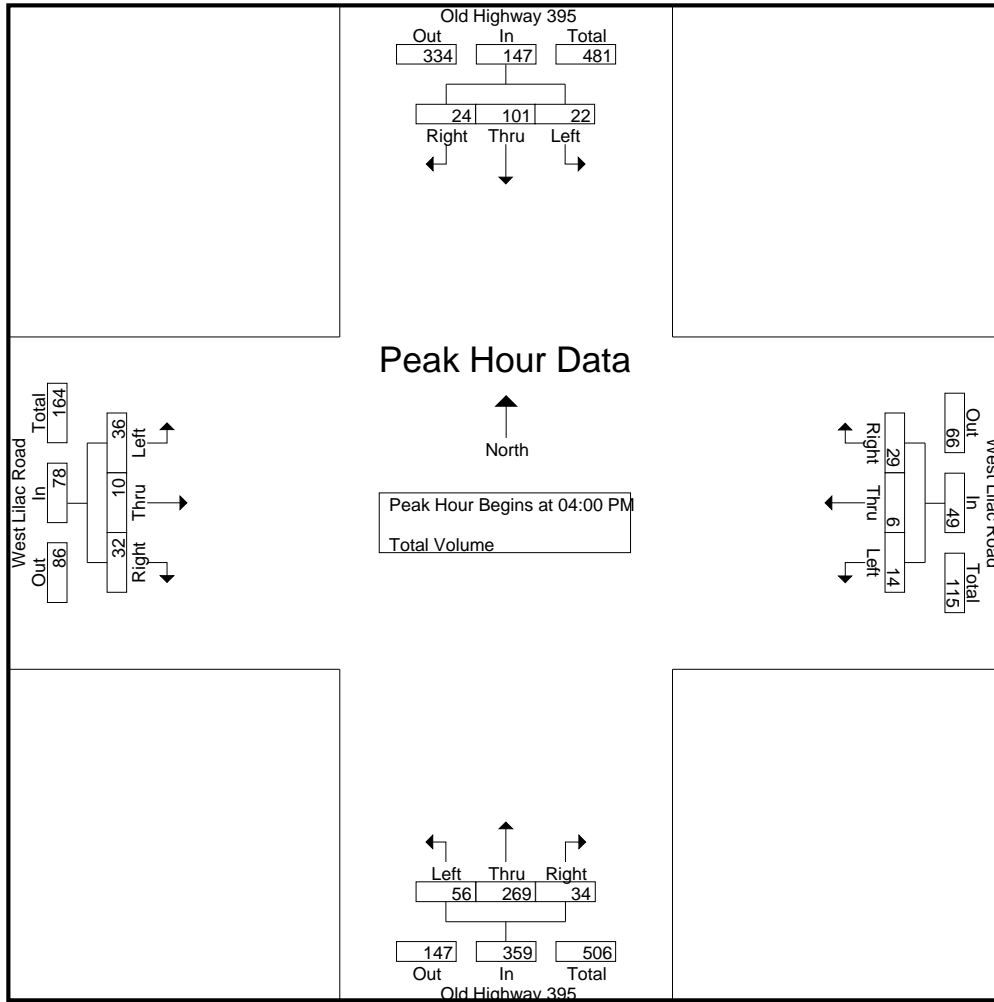

Peak Hour Analysis From 04:00 PM to 05:45 PM - Peak 1 of 1
 Peak Hour for Each Approach Begins at:

	04:30 PM				04:15 PM				04:00 PM				04:00 PM			
+0 mins.	4	28	8	40	5	3	10	18	14	60	7	81	12	4	8	24
+15 mins.	2	26	8	36	3	2	6	11	12	65	11	88	9	0	12	21
+30 mins.	5	22	7	34	1	1	7	9	19	85	10	114	8	1	10	19
+45 mins.	10	23	10	43	9	1	8	18	11	59	6	76	7	5	2	14
Total Volume	21	99	33	153	18	7	31	56	56	269	34	359	36	10	32	78
% App. Total	13.7	64.7	21.6		32.1	12.5	55.4		15.6	74.9	9.5		46.2	12.8	41	
PHF	.525	.884	.825	.890	.500	.583	.775	.778	.737	.791	.773	.787	.750	.500	.667	.813

County of San Diego
 N/S: I-15 Southbound Ramps
 E/W: Old Highway 395
 Weather: Clear

File Name : 07_CSD_15S_Old Hwy 395 AM
 Site Code : 00318811
 Start Date : 11/8/2018
 Page No : 1

Groups Printed- Total Volume

Start Time	I-15 Southbound Off Ramp Southbound				Old Highway 395 Westbound				I-15 Southbound On Ramp Northbound				Old Highway 395 Eastbound				Int. Total
	Left	Thru	Right	App. Total	Left	Thru	Right	App. Total	Left	Thru	Right	App. Total	Left	Thru	Right	App. Total	
07:00 AM	66	5	0	71	3	23	0	26	0	0	0	0	0	100	87	187	284
07:15 AM	33	5	2	40	4	23	0	27	0	0	0	0	0	95	113	208	275
07:30 AM	22	1	2	25	0	35	0	35	0	0	0	0	0	56	117	173	233
07:45 AM	64	1	3	68	0	42	0	42	0	0	0	0	0	60	64	124	234
Total	185	12	7	204	7	123	0	130	0	0	0	0	0	311	381	692	1026
08:00 AM	16	1	5	22	0	30	0	30	0	0	0	0	0	29	54	83	135
08:15 AM	15	2	2	19	2	27	0	29	0	0	0	0	0	36	66	102	150
08:30 AM	21	0	3	24	1	30	0	31	0	0	0	0	0	22	52	74	129
08:45 AM	10	1	2	13	1	23	0	24	0	0	0	0	0	15	31	46	83
Total	62	4	12	78	4	110	0	114	0	0	0	0	0	102	203	305	497
Grand Total	247	16	19	282	11	233	0	244	0	0	0	0	0	413	584	997	1523
Apprch %	87.6	5.7	6.7		4.5	95.5	0		0	0	0	0	0	41.4	58.6		
Total %	16.2	1.1	1.2	18.5	0.7	15.3	0	16	0	0	0	0	0	27.1	38.3	65.5	

Start Time	I-15 Southbound Off Ramp Southbound				Old Highway 395 Westbound				I-15 Southbound On Ramp Northbound				Old Highway 395 Eastbound				Int. Total
	Left	Thru	Right	App. Total	Left	Thru	Right	App. Total	Left	Thru	Right	App. Total	Left	Thru	Right	App. Total	
Peak Hour Analysis From 07:00 AM to 08:45 AM - Peak 1 of 1																	
Peak Hour for Entire Intersection Begins at 07:00 AM																	
07:00 AM	66	5	0	71	3	23	0	26	0	0	0	0	0	100	87	187	284
07:15 AM	33	5	2	40	4	23	0	27	0	0	0	0	0	95	113	208	275
07:30 AM	22	1	2	25	0	35	0	35	0	0	0	0	0	56	117	173	233
07:45 AM	64	1	3	68	0	42	0	42	0	0	0	0	0	60	64	124	234
Total Volume	185	12	7	204	7	123	0	130	0	0	0	0	0	311	381	692	1026
% App. Total	90.7	5.9	3.4		5.4	94.6	0		0	0	0	0	0	44.9	55.1		
PHF	.701	.600	.583	.718	.438	.732	.000	.774	.000	.000	.000	.000	.000	.778	.814	.832	.903

County of San Diego
 N/S: I-15 Southbound Ramps
 E/W: Old Highway 395
 Weather: Clear

File Name : 07_CSD_15S_Old Hwy 395 AM
 Site Code : 00318811
 Start Date : 11/8/2018
 Page No : 2

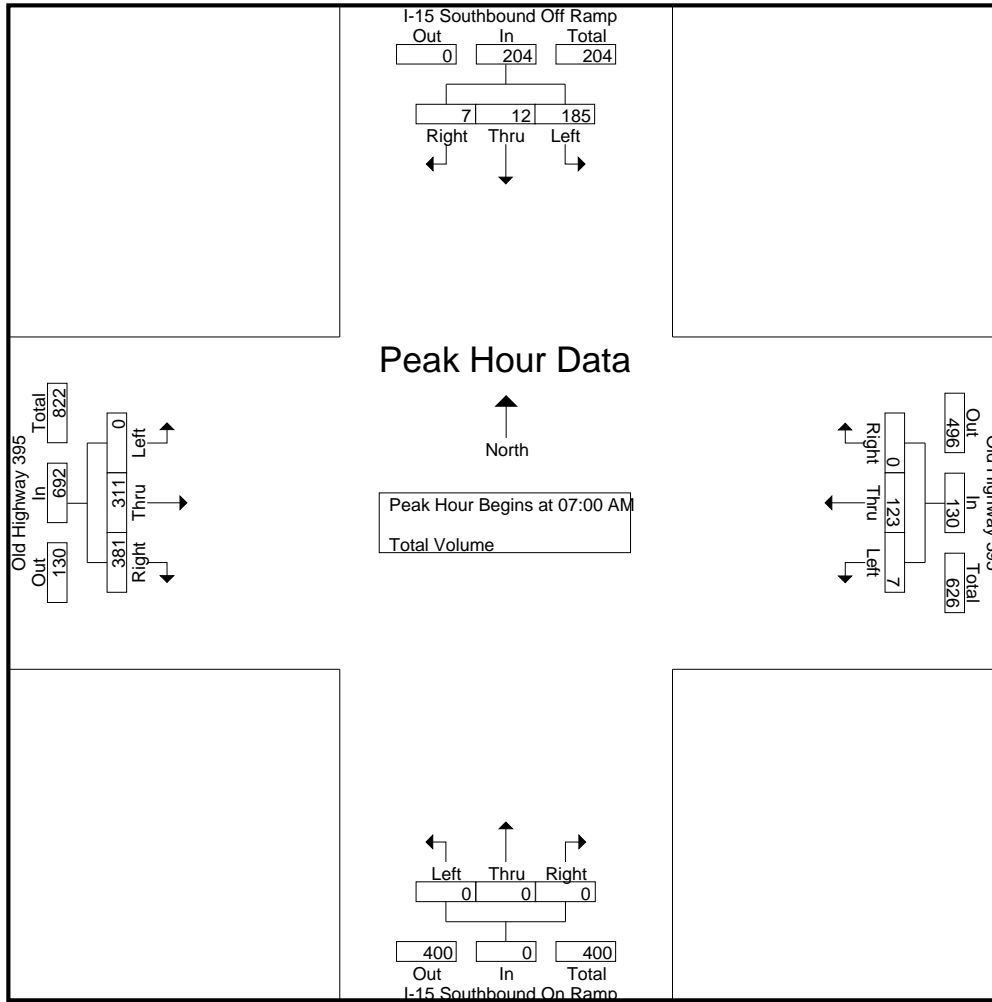

Peak Hour Analysis From 07:00 AM to 08:45 AM - Peak 1 of 1
 Peak Hour for Each Approach Begins at:

	07:00 AM				07:30 AM				07:00 AM				07:00 AM			
+0 mins.	66	5	0	71	0	35	0	35	0	0	0	0	0	100	87	187
+15 mins.	33	5	2	40	0	42	0	42	0	0	0	0	0	95	113	208
+30 mins.	22	1	2	25	0	30	0	30	0	0	0	0	0	56	117	173
+45 mins.	64	1	3	68	2	27	0	29	0	0	0	0	0	60	64	124
Total Volume	185	12	7	204	2	134	0	136	0	0	0	0	0	311	381	692
% App. Total	90.7	5.9	3.4		1.5	98.5	0		0	0	0	0	0	44.9	55.1	
PHF	.701	.600	.583	.718	.250	.798	.000	.810	.000	.000	.000	.000	.000	.778	.814	.832

County of San Diego
 N/S: I-15 Southbound Ramps
 E/W: Old Highway 395
 Weather: Clear

File Name : 07_CSD_15S_Old Hwy 395 PM
 Site Code : 00318811
 Start Date : 11/8/2018
 Page No : 1

Groups Printed- Total Volume

Start Time	I-15 Southbound Off Ramp Southbound				Old Highway 395 Westbound				I-15 Southbound On Ramp Northbound				Old Highway 395 Eastbound				Int. Total
	Left	Thru	Right	App. Total	Left	Thru	Right	App. Total	Left	Thru	Right	App. Total	Left	Thru	Right	App. Total	
04:00 PM	9	1	2	12	4	66	0	70	0	0	0	0	0	16	30	46	128
04:15 PM	17	1	1	19	1	92	0	93	0	0	0	0	0	11	34	45	157
04:30 PM	16	1	6	23	1	99	0	100	0	0	0	0	0	22	30	52	175
04:45 PM	20	0	1	21	2	86	0	88	0	0	0	0	0	17	21	38	147
Total	62	3	10	75	8	343	0	351	0	0	0	0	0	66	115	181	607
05:00 PM	17	4	4	25	1	69	0	70	0	0	0	0	0	7	35	42	137
05:15 PM	14	0	3	17	0	89	0	89	0	0	0	0	0	10	25	35	141
05:30 PM	15	0	3	18	2	79	0	81	0	0	0	0	0	11	21	32	131
05:45 PM	9	0	2	11	2	77	0	79	0	0	0	0	0	3	13	16	106
Total	55	4	12	71	5	314	0	319	0	0	0	0	0	31	94	125	515
Grand Total	117	7	22	146	13	657	0	670	0	0	0	0	0	97	209	306	1122
Apprch %	80.1	4.8	15.1		1.9	98.1	0		0	0	0	0	0	31.7	68.3		
Total %	10.4	0.6	2	13	1.2	58.6	0	59.7	0	0	0	0	0	8.6	18.6	27.3	

Start Time	I-15 Southbound Off Ramp Southbound				Old Highway 395 Westbound				I-15 Southbound On Ramp Northbound				Old Highway 395 Eastbound				Int. Total
	Left	Thru	Right	App. Total	Left	Thru	Right	App. Total	Left	Thru	Right	App. Total	Left	Thru	Right	App. Total	
Peak Hour Analysis From 04:00 PM to 05:45 PM - Peak 1 of 1																	
Peak Hour for Entire Intersection Begins at 04:15 PM																	
04:15 PM	17	1	1	19	1	92	0	93	0	0	0	0	0	11	34	45	157
04:30 PM	16	1	6	23	1	99	0	100	0	0	0	0	0	22	30	52	175
04:45 PM	20	0	1	21	2	86	0	88	0	0	0	0	0	17	21	38	147
05:00 PM	17	4	4	25	1	69	0	70	0	0	0	0	0	7	35	42	137
Total Volume	70	6	12	88	5	346	0	351	0	0	0	0	0	57	120	177	616
% App. Total	79.5	6.8	13.6		1.4	98.6	0		0	0	0	0	0	32.2	67.8		
PHF	.875	.375	.500	.880	.625	.874	.000	.878	.000	.000	.000	.000	.000	.648	.857	.851	.880

County of San Diego
 N/S: I-15 Southbound Ramps
 E/W: Old Highway 395
 Weather: Clear

File Name : 07_CSD_15S_Old Hwy 395 PM
 Site Code : 00318811
 Start Date : 11/8/2018
 Page No : 2

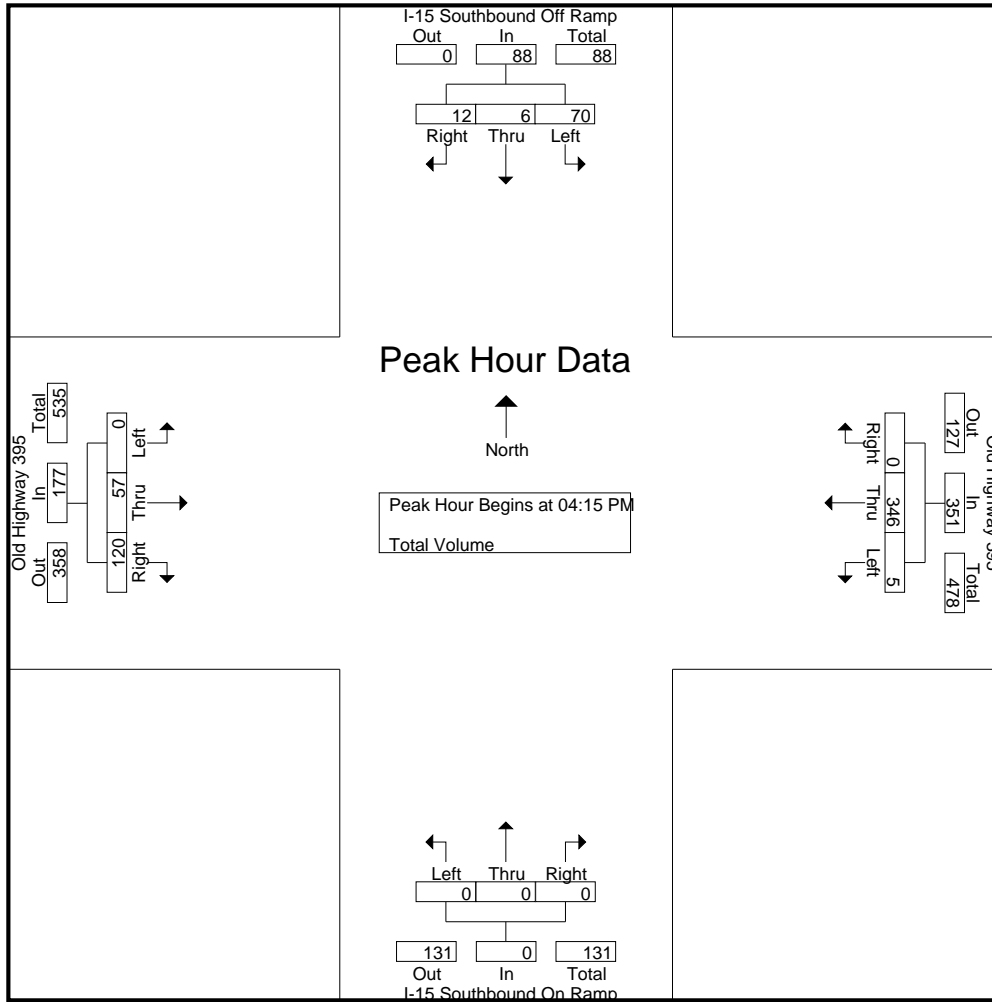

Peak Hour Analysis From 04:00 PM to 05:45 PM - Peak 1 of 1
 Peak Hour for Each Approach Begins at:

	04:15 PM				04:00 PM				04:00 PM				04:00 PM			
+0 mins.	17	1	1	19	4	66	0	70	0	0	0	0	0	16	30	46
+15 mins.	16	1	6	23	1	92	0	93	0	0	0	0	0	11	34	45
+30 mins.	20	0	1	21	1	99	0	100	0	0	0	0	0	22	30	52
+45 mins.	17	4	4	25	2	86	0	88	0	0	0	0	0	17	21	38
Total Volume	70	6	12	88	8	343	0	351	0	0	0	0	0	66	115	181
% App. Total	79.5	6.8	13.6		2.3	97.7	0		0	0	0		0	36.5	63.5	
PHF	.875	.375	.500	.880	.500	.866	.000	.878	.000	.000	.000	.000	.000	.750	.846	.870

County of San Diego
 N/S: I-15 Northbound Ramps
 E/W: Old Highway 395
 Weather: Clear

File Name : 08_CSD_15N_Old Hwy 395 AM
 Site Code : 00318811
 Start Date : 11/8/2018
 Page No : 1

Groups Printed- Total Volume

Start Time	I-15 Northbound On Ramp Southbound				Old Highway 395 Westbound				I-15 Northbound Off Ramp Northbound				Old Highway 395 Eastbound				Int. Total
	Left	Thru	Right	App. Total	Left	Thru	Right	App. Total	Left	Thru	Right	App. Total	Left	Thru	Right	App. Total	
07:00 AM	0	0	0	0	0	9	8	17	20	0	1	21	0	162	1	163	201
07:15 AM	0	0	0	0	0	11	13	24	10	0	0	10	0	125	0	125	159
07:30 AM	0	0	0	0	0	10	15	25	21	0	2	23	0	78	0	78	126
07:45 AM	0	0	0	0	0	12	13	25	30	0	1	31	0	123	4	127	183
Total	0	0	0	0	0	42	49	91	81	0	4	85	0	488	5	493	669
08:00 AM	0	0	0	0	0	18	9	27	13	0	0	13	0	40	5	45	85
08:15 AM	0	0	0	0	0	15	10	25	15	0	2	17	0	49	2	51	93
08:30 AM	0	0	0	0	0	7	15	22	25	0	2	27	0	36	7	43	92
08:45 AM	0	0	0	0	0	10	6	16	16	0	1	17	0	24	0	24	57
Total	0	0	0	0	0	50	40	90	69	0	5	74	0	149	14	163	327
Grand Total	0	0	0	0	0	92	89	181	150	0	9	159	0	637	19	656	996
Apprch %	0	0	0		0	50.8	49.2		94.3	0	5.7		0	97.1	2.9		
Total %	0	0	0	0	0	9.2	8.9	18.2	15.1	0	0.9	16	0	64	1.9	65.9	

Start Time	I-15 Northbound On Ramp Southbound				Old Highway 395 Westbound				I-15 Northbound Off Ramp Northbound				Old Highway 395 Eastbound				Int. Total
	Left	Thru	Right	App. Total	Left	Thru	Right	App. Total	Left	Thru	Right	App. Total	Left	Thru	Right	App. Total	
07:00 AM	0	0	0	0	0	9	8	17	20	0	1	21	0	162	1	163	201
07:15 AM	0	0	0	0	0	11	13	24	10	0	0	10	0	125	0	125	159
07:30 AM	0	0	0	0	0	10	15	25	21	0	2	23	0	78	0	78	126
07:45 AM	0	0	0	0	0	12	13	25	30	0	1	31	0	123	4	127	183
Total Volume	0	0	0	0	0	42	49	91	81	0	4	85	0	488	5	493	669
% App. Total	0	0	0		0	46.2	53.8		95.3	0	4.7		0	99	1		
PHF	.000	.000	.000	.000	.000	.875	.817	.910	.675	.000	.500	.685	.000	.753	.313	.756	.832

Peak Hour Analysis From 07:00 AM to 08:45 AM - Peak 1 of 1
 Peak Hour for Entire Intersection Begins at 07:00 AM

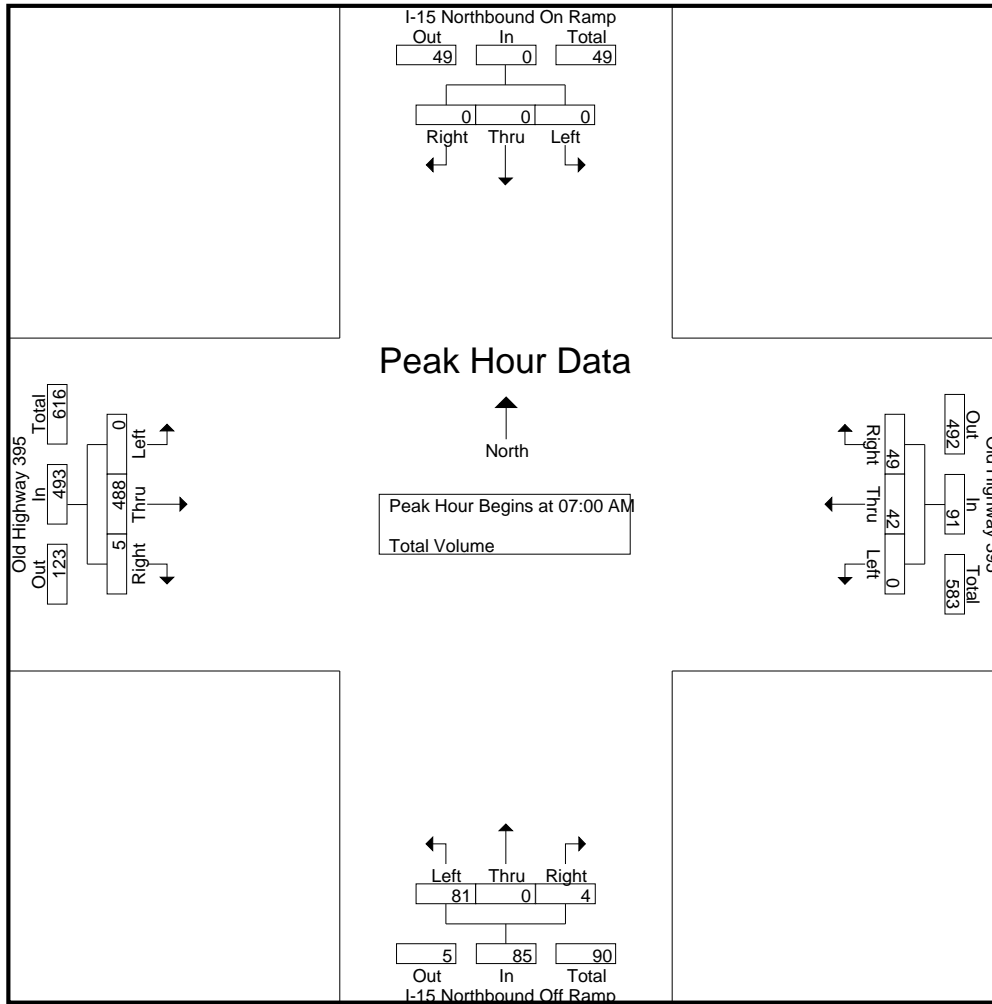

Peak Hour Analysis From 07:00 AM to 08:45 AM - Peak 1 of 1
 Peak Hour for Each Approach Begins at:

	07:00 AM				07:30 AM				07:45 AM				07:00 AM			
+0 mins.	0	0	0	0	0	10	15	25	30	0	1	31	0	162	1	163
+15 mins.	0	0	0	0	0	12	13	25	13	0	0	13	0	125	0	125
+30 mins.	0	0	0	0	0	18	9	27	15	0	2	17	0	78	0	78
+45 mins.	0	0	0	0	0	15	10	25	25	0	2	27	0	123	4	127
Total Volume	0	0	0	0	0	55	47	102	83	0	5	88	0	488	5	493
% App. Total	0	0	0	0	0	53.9	46.1		94.3	0	5.7		0	99	1	
PHF	.000	.000	.000	.000	.000	.764	.783	.944	.692	.000	.625	.710	.000	.753	.313	.756

County of San Diego
 N/S: I-15 Northbound Ramps
 E/W: Old Highway 395
 Weather: Clear

File Name : 08_CSD_15N_Old Hwy 395 PM
 Site Code : 00318811
 Start Date : 11/8/2018
 Page No : 1

Groups Printed- Total Volume

Start Time	I-15 Northbound On Ramp Southbound				Old Highway 395 Westbound				I-15 Northbound Off Ramp Northbound				Old Highway 395 Eastbound				Int. Total
	Left	Thru	Right	App. Total	Left	Thru	Right	App. Total	Left	Thru	Right	App. Total	Left	Thru	Right	App. Total	
04:00 PM	0	0	0	0	0	34	15	49	35	0	3	38	0	24	1	25	112
04:15 PM	0	0	0	0	0	41	9	50	50	0	5	55	0	26	0	26	131
04:30 PM	0	0	0	0	0	40	11	51	64	0	5	69	0	36	0	36	156
04:45 PM	0	0	0	0	0	35	10	45	50	0	5	55	0	33	4	37	137
Total	0	0	0	0	0	150	45	195	199	0	18	217	0	119	5	124	536
05:00 PM	0	0	0	0	0	32	9	41	36	0	6	42	0	27	5	32	115
05:15 PM	0	0	0	0	0	28	12	40	59	0	5	64	0	24	2	26	130
05:30 PM	0	0	0	0	0	34	10	44	51	0	6	57	0	20	7	27	128
05:45 PM	0	0	0	0	0	28	9	37	52	0	2	54	0	13	0	13	104
Total	0	0	0	0	0	122	40	162	198	0	19	217	0	84	14	98	477
Grand Total	0	0	0	0	0	272	85	357	397	0	37	434	0	203	19	222	1013
Apprch %	0	0	0		0	76.2	23.8		91.5	0	8.5		0	91.4	8.6		
Total %	0	0	0	0	0	26.9	8.4	35.2	39.2	0	3.7	42.8	0	20	1.9	21.9	

Start Time	I-15 Northbound On Ramp Southbound				Old Highway 395 Westbound				I-15 Northbound Off Ramp Northbound				Old Highway 395 Eastbound				Int. Total
	Left	Thru	Right	App. Total	Left	Thru	Right	App. Total	Left	Thru	Right	App. Total	Left	Thru	Right	App. Total	
Peak Hour Analysis From 04:00 PM to 05:45 PM - Peak 1 of 1																	
Peak Hour for Entire Intersection Begins at 04:15 PM																	
04:15 PM	0	0	0	0	0	41	9	50	50	0	5	55	0	26	0	26	131
04:30 PM	0	0	0	0	0	40	11	51	64	0	5	69	0	36	0	36	156
04:45 PM	0	0	0	0	0	35	10	45	50	0	5	55	0	33	4	37	137
05:00 PM	0	0	0	0	0	32	9	41	36	0	6	42	0	27	5	32	115
Total Volume	0	0	0	0	0	148	39	187	200	0	21	221	0	122	9	131	539
% App. Total	0	0	0		0	79.1	20.9		90.5	0	9.5		0	93.1	6.9		
PHF	.000	.000	.000	.000	.000	.902	.886	.917	.781	.000	.875	.801	.000	.847	.450	.885	.864

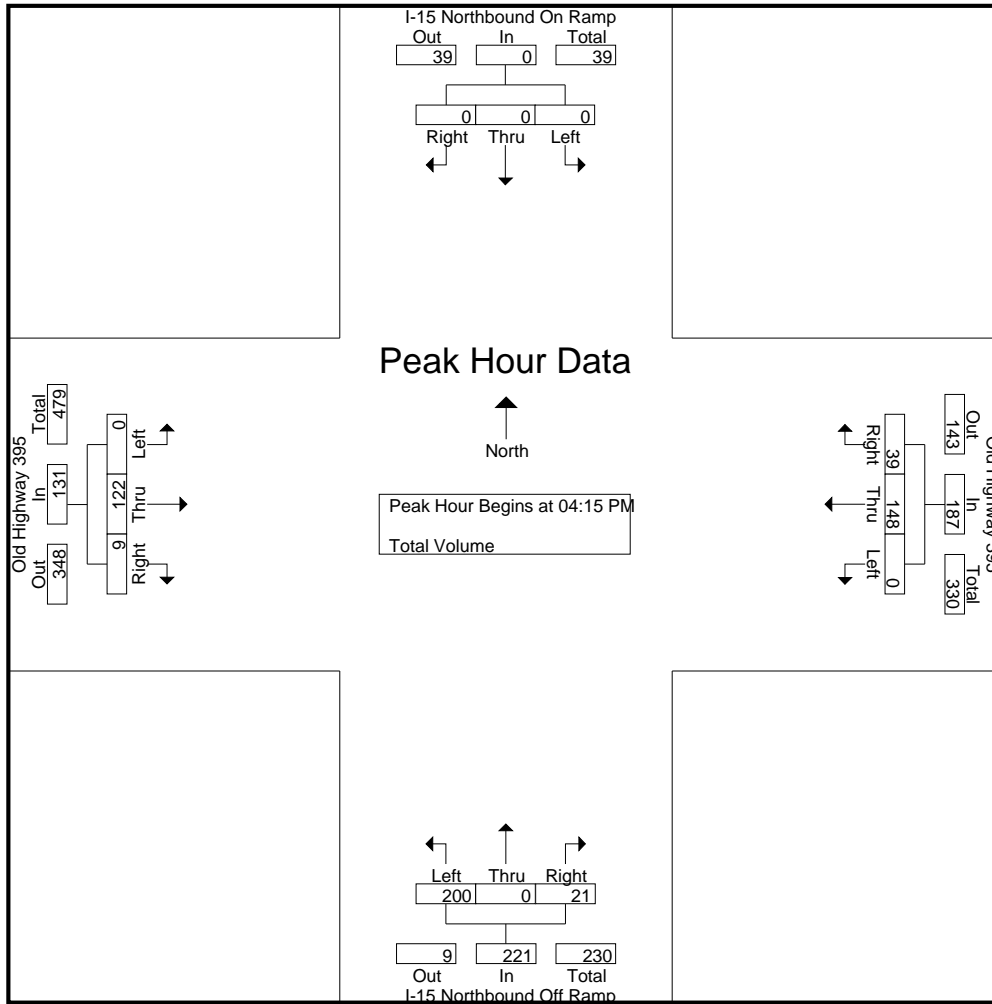

Peak Hour Analysis From 04:00 PM to 05:45 PM - Peak 1 of 1
 Peak Hour for Each Approach Begins at:

	04:00 PM				04:00 PM				04:30 PM				04:15 PM			
+0 mins.	0	0	0	0	0	34	15	49	64	0	5	69	0	26	0	26
+15 mins.	0	0	0	0	0	41	9	50	50	0	5	55	0	36	0	36
+30 mins.	0	0	0	0	0	40	11	51	36	0	6	42	0	33	4	37
+45 mins.	0	0	0	0	0	35	10	45	59	0	5	64	0	27	5	32
Total Volume	0	0	0	0	0	150	45	195	209	0	21	230	0	122	9	131
% App. Total	0	0	0	0	0	76.9	23.1		90.9	0	9.1		0	93.1	6.9	
PHF	.000	.000	.000	.000	.000	.915	.750	.956	.816	.000	.875	.833	.000	.847	.450	.885

County of San Diego
 N/S: Old Highway 395
 E/W: Camino Del Rey
 Weather: Clear

Groups Printed- Total Volume

Start Time	Old Highway 395 Southbound			Old Highway 395 Northbound			Camino Del Rey Eastbound			Int. Total
	Thru	Right	App. Total	Left	Thru	App. Total	Left	Right	App. Total	
07:00 AM	167	7	174	33	12	45	2	64	66	285
07:15 AM	140	14	154	26	21	47	5	71	76	277
07:30 AM	87	6	93	36	13	49	8	86	94	236
07:45 AM	117	9	126	32	16	48	5	59	64	238
Total	511	36	547	127	62	189	20	280	300	1036
08:00 AM	49	5	54	32	23	55	6	63	69	178
08:15 AM	52	0	52	28	25	53	1	62	63	168
08:30 AM	33	3	36	27	20	47	5	50	55	138
08:45 AM	29	3	32	24	17	41	2	45	47	120
Total	163	11	174	111	85	196	14	220	234	604
Grand Total	674	47	721	238	147	385	34	500	534	1640
Apprch %	93.5	6.5		61.8	38.2		6.4	93.6		
Total %	41.1	2.9	44	14.5	9	23.5	2.1	30.5	32.6	

Start Time	Old Highway 395 Southbound			Old Highway 395 Northbound			Camino Del Rey Eastbound			Int. Total
	Thru	Right	App. Total	Left	Thru	App. Total	Left	Right	App. Total	
07:00 AM	167	7	174	33	12	45	2	64	66	285
07:15 AM	140	14	154	26	21	47	5	71	76	277
07:30 AM	87	6	93	36	13	49	8	86	94	236
07:45 AM	117	9	126	32	16	48	5	59	64	238
Total Volume	511	36	547	127	62	189	20	280	300	1036
% App. Total	93.4	6.6		67.2	32.8		6.7	93.3		
PHF	.765	.643	.786	.882	.738	.964	.625	.814	.798	.909

Peak Hour Analysis From 07:00 AM to 08:45 AM - Peak 1 of 1

Peak Hour for Entire Intersection Begins at 07:00 AM

County of San Diego
 N/S: Old Highway 395
 E/W: Camino Del Rey
 Weather: Clear

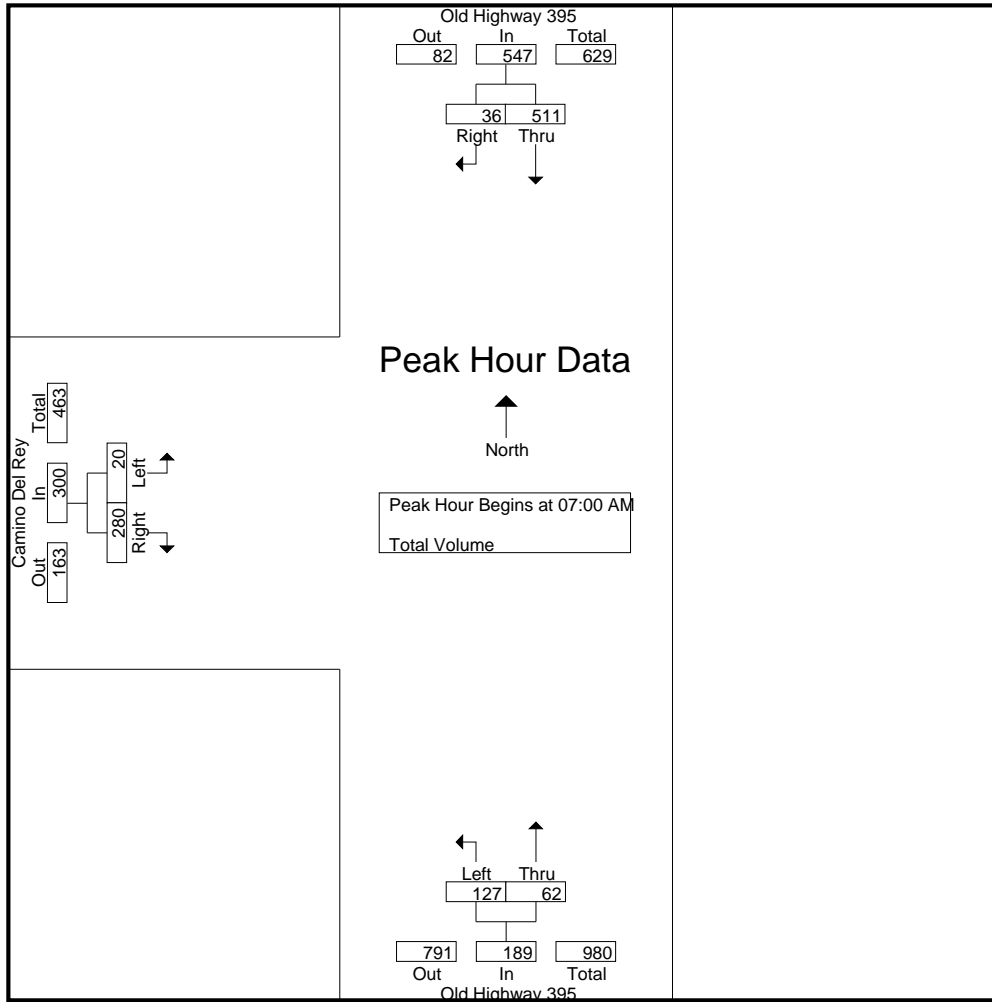

Peak Hour Analysis From 07:00 AM to 08:45 AM - Peak 1 of 1

Peak Hour for Each Approach Begins at:

	07:00 AM			07:30 AM			07:15 AM		
+0 mins.	167	7	174	36	13	49	5	71	76
+15 mins.	140	14	154	32	16	48	8	86	94
+30 mins.	87	6	93	32	23	55	5	59	64
+45 mins.	117	9	126	28	25	53	6	63	69
Total Volume	511	36	547	128	77	205	24	279	303
% App. Total	93.4	6.6		62.4	37.6		7.9	92.1	
PHF	.765	.643	.786	.889	.770	.932	.750	.811	.806

County of San Diego
 N/S: Old Highway 395
 E/W: Camino Del Rey
 Weather: Clear

Groups Printed- Total Volume

Start Time	Old Highway 395 Southbound			Old Highway 395 Northbound			Camino Del Rey Eastbound			Int. Total
	Thru	Right	App. Total	Left	Thru	App. Total	Left	Right	App. Total	
04:00 PM	19	2	21	100	51	151	5	44	49	221
04:15 PM	36	2	38	99	60	159	6	43	49	246
04:30 PM	30	7	37	105	63	168	5	37	42	247
04:45 PM	26	7	33	94	49	143	4	31	35	211
Total	111	18	129	398	223	621	20	155	175	925
05:00 PM	40	3	43	78	43	121	3	38	41	205
05:15 PM	18	1	19	83	58	141	1	35	36	196
05:30 PM	28	4	32	72	49	121	2	34	36	189
05:45 PM	12	4	16	67	52	119	3	26	29	164
Total	98	12	110	300	202	502	9	133	142	754
Grand Total	209	30	239	698	425	1123	29	288	317	1679
Apprch %	87.4	12.6		62.2	37.8		9.1	90.9		
Total %	12.4	1.8	14.2	41.6	25.3	66.9	1.7	17.2	18.9	

Start Time	Old Highway 395 Southbound			Old Highway 395 Northbound			Camino Del Rey Eastbound			Int. Total
	Thru	Right	App. Total	Left	Thru	App. Total	Left	Right	App. Total	
04:00 PM	19	2	21	100	51	151	5	44	49	221
04:15 PM	36	2	38	99	60	159	6	43	49	246
04:30 PM	30	7	37	105	63	168	5	37	42	247
04:45 PM	26	7	33	94	49	143	4	31	35	211
Total Volume	111	18	129	398	223	621	20	155	175	925
% App. Total	86	14		64.1	35.9		11.4	88.6		
PHF	.771	.643	.849	.948	.885	.924	.833	.881	.893	.936

Peak Hour Analysis From 04:00 PM to 05:45 PM - Peak 1 of 1

Peak Hour for Entire Intersection Begins at 04:00 PM

County of San Diego
 N/S: Old Highway 395
 E/W: Camino Del Rey
 Weather: Clear

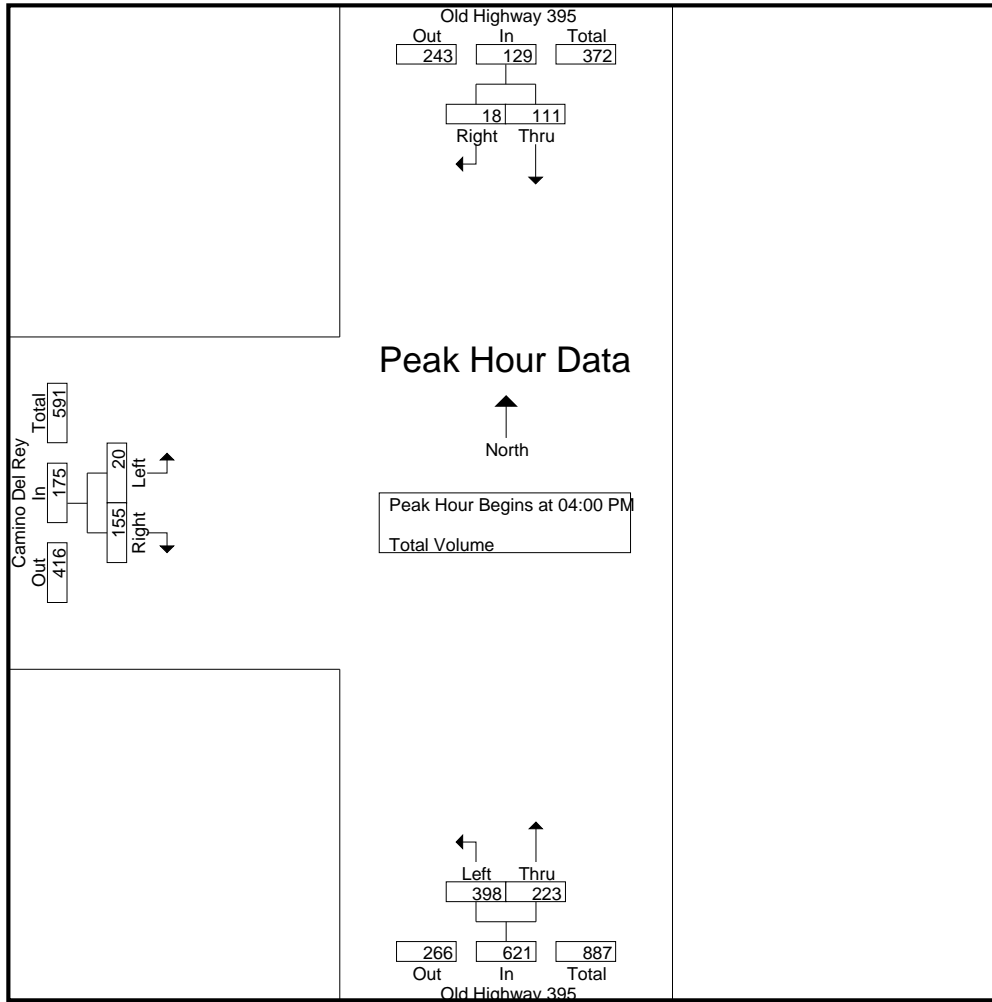

Peak Hour Analysis From 04:00 PM to 05:45 PM - Peak 1 of 1

Peak Hour for Each Approach Begins at:

	04:15 PM			04:00 PM			04:00 PM		
+0 mins.	36	2	38	100	51	151	5	44	49
+15 mins.	30	7	37	99	60	159	6	43	49
+30 mins.	26	7	33	105	63	168	5	37	42
+45 mins.	40	3	43	94	49	143	4	31	35
Total Volume	132	19	151	398	223	621	20	155	175
% App. Total	87.4	12.6		64.1	35.9		11.4	88.6	
PHF	.825	.679	.878	.948	.885	.924	.833	.881	.893

County of San Diego
 N/S: Old Highway 395
 E/W: Circle R Drive
 Weather: Clear

Groups Printed- Total Volume

Start Time	Old Highway 395 Southbound			Circle R Drive Westbound			Old Highway 395 Northbound			Int. Total
	Left	Thru	App. Total	Left	Right	App. Total	Thru	Right	App. Total	
07:00 AM	4	216	220	74	14	88	41	13	54	362
07:15 AM	2	226	228	72	6	78	41	14	55	361
07:30 AM	4	194	198	62	7	69	41	24	65	332
07:45 AM	6	176	182	35	4	39	46	26	72	293
Total	16	812	828	243	31	274	169	77	246	1348
08:00 AM	6	122	128	45	7	52	50	24	74	254
08:15 AM	6	120	126	34	7	41	47	25	72	239
08:30 AM	9	77	86	36	6	42	47	21	68	196
08:45 AM	5	75	80	39	5	44	38	25	63	187
Total	26	394	420	154	25	179	182	95	277	876
Grand Total	42	1206	1248	397	56	453	351	172	523	2224
Apprch %	3.4	96.6		87.6	12.4		67.1	32.9		
Total %	1.9	54.2	56.1	17.9	2.5	20.4	15.8	7.7	23.5	

Start Time	Old Highway 395 Southbound			Circle R Drive Westbound			Old Highway 395 Northbound			Int. Total
	Left	Thru	App. Total	Left	Right	App. Total	Thru	Right	App. Total	
07:00 AM	4	216	220	74	14	88	41	13	54	362
07:15 AM	2	226	228	72	6	78	41	14	55	361
07:30 AM	4	194	198	62	7	69	41	24	65	332
07:45 AM	6	176	182	35	4	39	46	26	72	293
Total Volume	16	812	828	243	31	274	169	77	246	1348
% App. Total	1.9	98.1		88.7	11.3		68.7	31.3		
PHF	.667	.898	.908	.821	.554	.778	.918	.740	.854	.931

Peak Hour Analysis From 07:00 AM to 08:45 AM - Peak 1 of 1

Peak Hour for Entire Intersection Begins at 07:00 AM

County of San Diego
 N/S: Old Highway 395
 E/W: Circle R Drive
 Weather: Clear

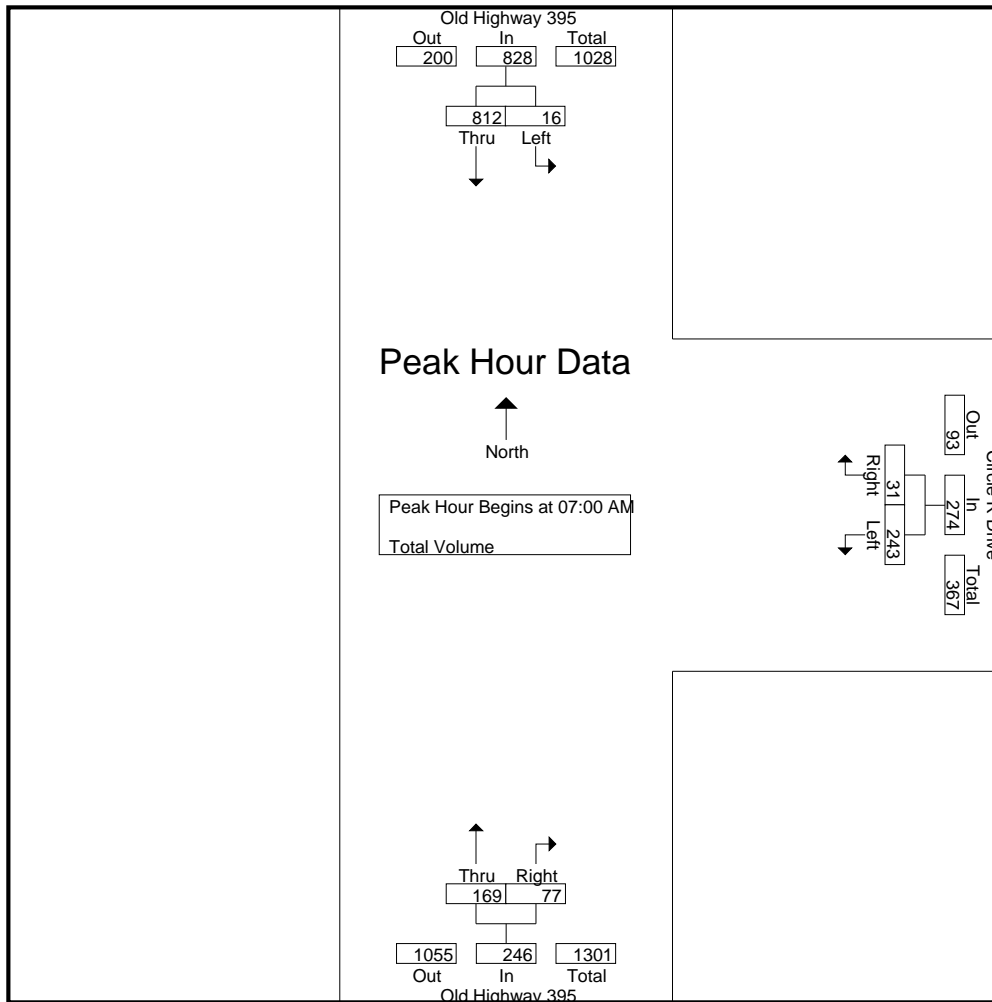

Peak Hour Analysis From 07:00 AM to 08:45 AM - Peak 1 of 1
 Peak Hour for Each Approach Begins at:

	07:00 AM			07:00 AM			07:45 AM		
+0 mins.	4	216	220	74	14	88	46	26	72
+15 mins.	2	226	228	72	6	78	50	24	74
+30 mins.	4	194	198	62	7	69	47	25	72
+45 mins.	6	176	182	35	4	39	47	21	68
Total Volume	16	812	828	243	31	274	190	96	286
% App. Total	1.9	98.1		88.7	11.3		66.4	33.6	
PHF	.667	.898	.908	.821	.554	.778	.950	.923	.966

County of San Diego
 N/S: Old Highway 395
 E/W: Circle R Drive
 Weather: Clear

Groups Printed- Total Volume

Start Time	Old Highway 395 Southbound			Circle R Drive Westbound			Old Highway 395 Northbound			Int. Total
	Left	Thru	App. Total	Left	Right	App. Total	Thru	Right	App. Total	
04:00 PM	8	68	76	32	7	39	148	33	181	296
04:15 PM	8	69	77	34	6	40	168	43	211	328
04:30 PM	12	58	70	41	15	56	162	56	218	344
04:45 PM	10	58	68	33	11	44	141	51	192	304
Total	38	253	291	140	39	179	619	183	802	1272
05:00 PM	11	71	82	31	5	36	123	56	179	297
05:15 PM	6	48	54	22	6	28	144	59	203	285
05:30 PM	6	71	77	18	4	22	121	61	182	281
05:45 PM	14	37	51	18	4	22	125	54	179	252
Total	37	227	264	89	19	108	513	230	743	1115
Grand Total	75	480	555	229	58	287	1132	413	1545	2387
Apprch %	13.5	86.5		79.8	20.2		73.3	26.7		
Total %	3.1	20.1	23.3	9.6	2.4	12	47.4	17.3	64.7	

Start Time	Old Highway 395 Southbound			Circle R Drive Westbound			Old Highway 395 Northbound			Int. Total
	Left	Thru	App. Total	Left	Right	App. Total	Thru	Right	App. Total	
04:15 PM	8	69	77	34	6	40	168	43	211	328
04:30 PM	12	58	70	41	15	56	162	56	218	344
04:45 PM	10	58	68	33	11	44	141	51	192	304
05:00 PM	11	71	82	31	5	36	123	56	179	297
Total Volume	41	256	297	139	37	176	594	206	800	1273
% App. Total	13.8	86.2		79	21		74.2	25.8		
PHF	.854	.901	.905	.848	.617	.786	.884	.920	.917	.925

Peak Hour Analysis From 04:00 PM to 05:45 PM - Peak 1 of 1

Peak Hour for Entire Intersection Begins at 04:15 PM

County of San Diego
 N/S: Old Highway 395
 E/W: Circle R Drive
 Weather: Clear

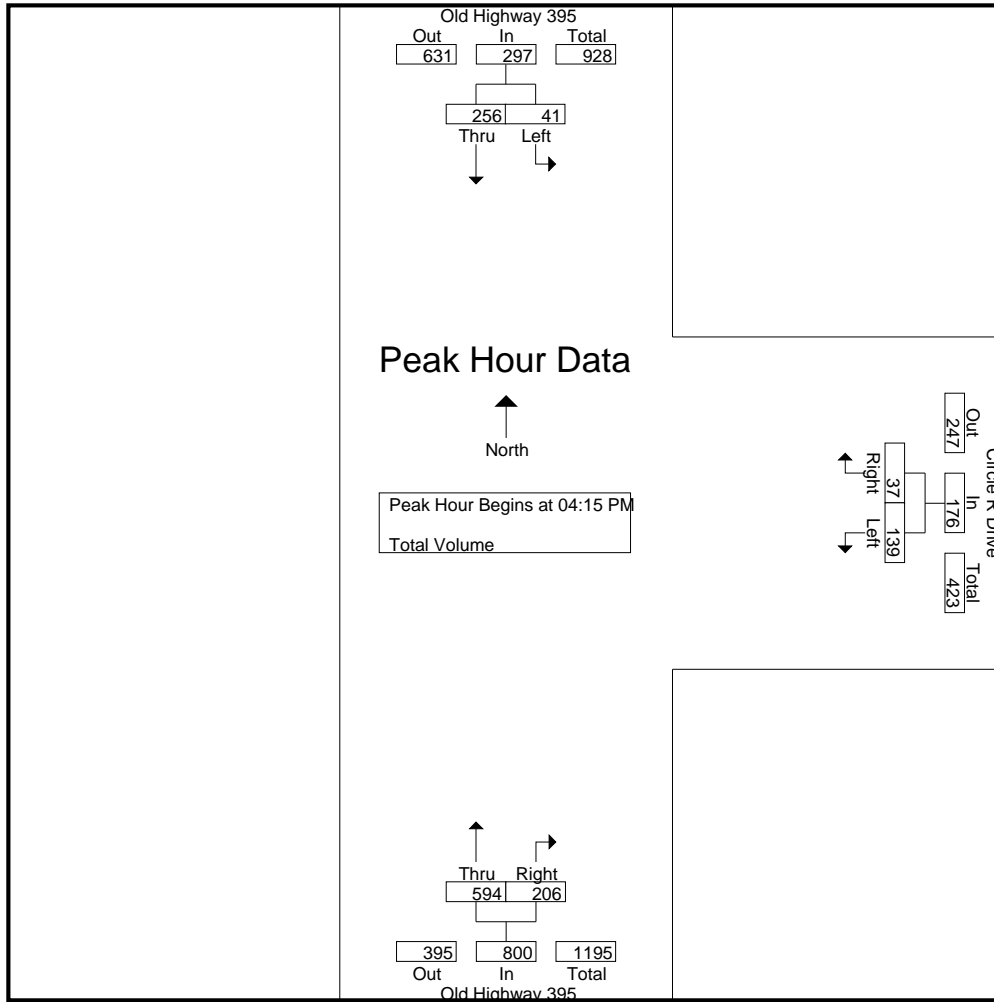

Peak Hour Analysis From 04:00 PM to 05:45 PM - Peak 1 of 1
 Peak Hour for Each Approach Begins at:

	04:15 PM			04:00 PM			04:00 PM		
+0 mins.	8	69	77	32	7	39	148	33	181
+15 mins.	12	58	70	34	6	40	168	43	211
+30 mins.	10	58	68	41	15	56	162	56	218
+45 mins.	11	71	82	33	11	44	141	51	192
Total Volume	41	256	297	140	39	179	619	183	802
% App. Total	13.8	86.2		78.2	21.8		77.2	22.8	
PHF	.854	.901	.905	.854	.650	.799	.921	.817	.920

County of San Diego
 N/S: Old Highway 395/Champagne Boulevard
 E/W: Gopher Canyon Road
 Weather: Clear

File Name : 11_CSD_Old Hwy 395_Gopher Canyon AM
 Site Code : 00318811
 Start Date : 11/8/2018
 Page No : 1

Groups Printed- Total Volume

Start Time	Old Highway 395 Southbound			Champagne Boulevard Northbound			Gopher Canyon Road Eastbound			Int. Total
	Thru	Right	App. Total	Left	Thru	App. Total	Left	Right	App. Total	
07:00 AM	157	132	289	72	11	83	38	51	89	461
07:15 AM	123	168	291	85	24	109	38	42	80	480
07:30 AM	117	141	258	79	27	106	40	37	77	441
07:45 AM	117	97	214	51	36	87	32	40	72	373
Total	514	538	1052	287	98	385	148	170	318	1755
08:00 AM	71	95	166	66	25	91	48	42	90	347
08:15 AM	69	82	151	65	35	100	40	36	76	327
08:30 AM	45	67	112	63	26	89	44	27	71	272
08:45 AM	38	70	108	59	16	75	43	30	73	256
Total	223	314	537	253	102	355	175	135	310	1202
Grand Total	737	852	1589	540	200	740	323	305	628	2957
Apprch %	46.4	53.6		73	27		51.4	48.6		
Total %	24.9	28.8	53.7	18.3	6.8	25	10.9	10.3	21.2	

Start Time	Old Highway 395 Southbound			Champagne Boulevard Northbound			Gopher Canyon Road Eastbound			Int. Total
	Thru	Right	App. Total	Left	Thru	App. Total	Left	Right	App. Total	
07:00 AM	157	132	289	72	11	83	38	51	89	461
07:15 AM	123	168	291	85	24	109	38	42	80	480
07:30 AM	117	141	258	79	27	106	40	37	77	441
07:45 AM	117	97	214	51	36	87	32	40	72	373
Total Volume	514	538	1052	287	98	385	148	170	318	1755
% App. Total	48.9	51.1		74.5	25.5		46.5	53.5		
PHF	.818	.801	.904	.844	.681	.883	.925	.833	.893	.914

Peak Hour Analysis From 07:00 AM to 08:45 AM - Peak 1 of 1

Peak Hour for Entire Intersection Begins at 07:00 AM

County of San Diego
 N/S: Old Highway 395/Champagne Boulevard
 E/W: Gopher Canyon Road
 Weather: Clear

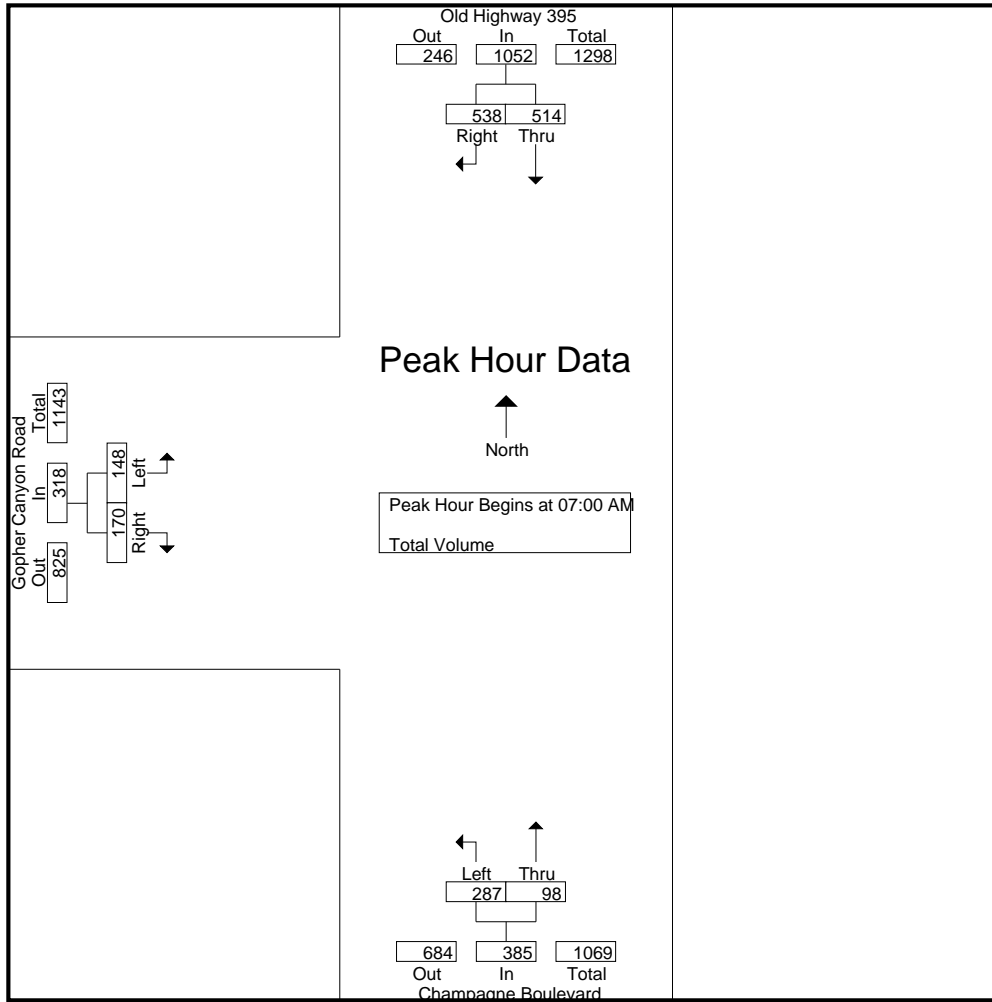

Peak Hour Analysis From 07:00 AM to 08:45 AM - Peak 1 of 1
 Peak Hour for Each Approach Begins at:

	07:00 AM			07:15 AM			07:15 AM		
+0 mins.	157	132	289	85	24	109	38	42	80
+15 mins.	123	168	291	79	27	106	40	37	77
+30 mins.	117	141	258	51	36	87	32	40	72
+45 mins.	117	97	214	66	25	91	48	42	90
Total Volume	514	538	1052	281	112	393	158	161	319
% App. Total	48.9	51.1		71.5	28.5		49.5	50.5	
PHF	.818	.801	.904	.826	.778	.901	.823	.958	.886

County of San Diego
 N/S: Old Highway 395/Champagne Boulevard
 E/W: Gopher Canyon Road
 Weather: Clear

File Name : 11_CSD_Old Hwy 395_Gopher Canyon PM
 Site Code : 00318811
 Start Date : 11/8/2018
 Page No : 1

Groups Printed- Total Volume

Start Time	Old Highway 395 Southbound			Champagne Boulevard Northbound			Gopher Canyon Road Eastbound			Int. Total
	Thru	Right	App. Total	Left	Thru	App. Total	Left	Right	App. Total	
04:00 PM	44	54	98	61	64	125	120	55	175	398
04:15 PM	39	61	100	57	71	128	141	56	197	425
04:30 PM	48	56	104	65	97	162	125	54	179	445
04:45 PM	40	50	90	59	68	127	128	61	189	406
Total	171	221	392	242	300	542	514	226	740	1674
05:00 PM	42	61	103	73	73	146	109	68	177	426
05:15 PM	23	42	65	71	75	146	135	68	203	414
05:30 PM	35	58	93	60	72	132	118	70	188	413
05:45 PM	17	35	52	54	67	121	123	79	202	375
Total	117	196	313	258	287	545	485	285	770	1628
Grand Total	288	417	705	500	587	1087	999	511	1510	3302
Apprch %	40.9	59.1		46	54		66.2	33.8		
Total %	8.7	12.6	21.4	15.1	17.8	32.9	30.3	15.5	45.7	

Start Time	Old Highway 395 Southbound			Champagne Boulevard Northbound			Gopher Canyon Road Eastbound			Int. Total
	Thru	Right	App. Total	Left	Thru	App. Total	Left	Right	App. Total	
04:15 PM	39	61	100	57	71	128	141	56	197	425
04:30 PM	48	56	104	65	97	162	125	54	179	445
04:45 PM	40	50	90	59	68	127	128	61	189	406
05:00 PM	42	61	103	73	73	146	109	68	177	426
Total Volume	169	228	397	254	309	563	503	239	742	1702
% App. Total	42.6	57.4		45.1	54.9		67.8	32.2		
PHF	.880	.934	.954	.870	.796	.869	.892	.879	.942	.956

Peak Hour Analysis From 04:00 PM to 05:45 PM - Peak 1 of 1

Peak Hour for Entire Intersection Begins at 04:15 PM

County of San Diego
 N/S: Old Highway 395/Champagne Boulevard
 E/W: Gopher Canyon Road
 Weather: Clear

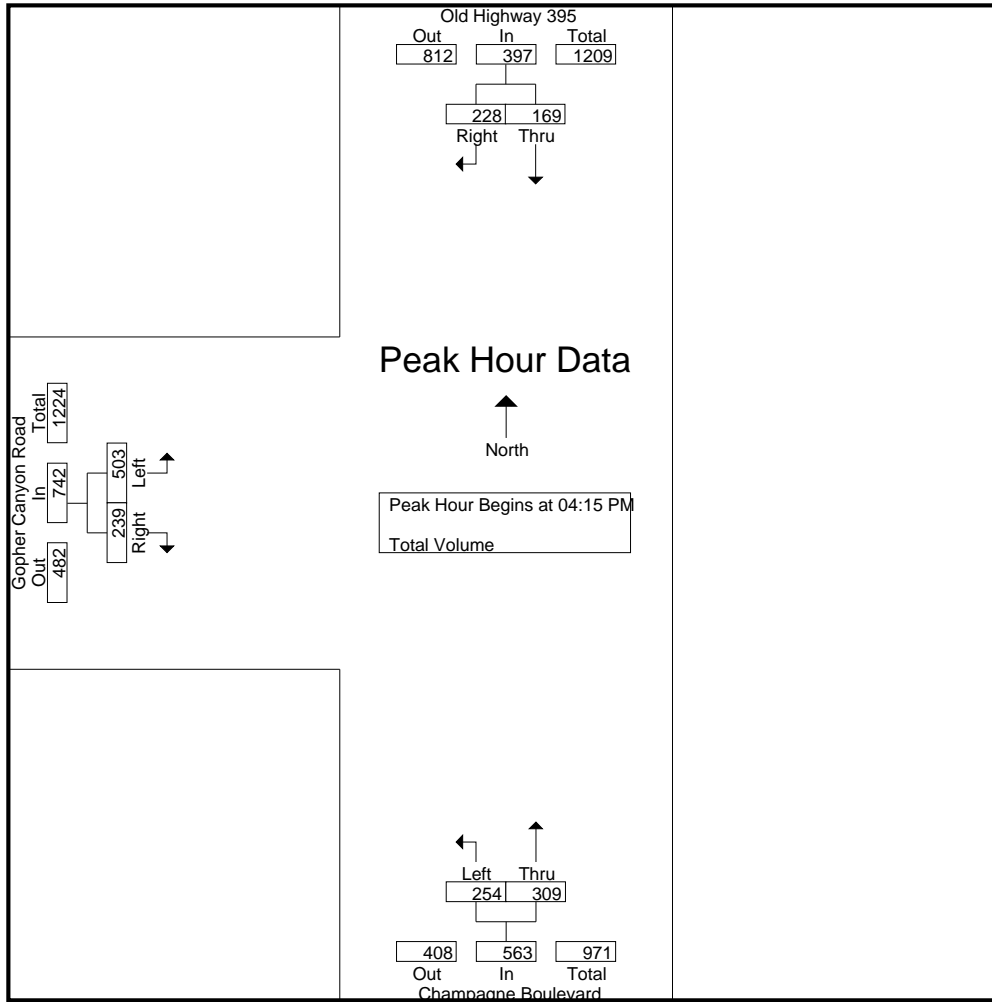

Peak Hour Analysis From 04:00 PM to 05:45 PM - Peak 1 of 1

Peak Hour for Each Approach Begins at:

	04:15 PM			04:30 PM			05:00 PM		
+0 mins.	39	61	100	65	97	162	109	68	177
+15 mins.	48	56	104	59	68	127	135	68	203
+30 mins.	40	50	90	73	73	146	118	70	188
+45 mins.	42	61	103	71	75	146	123	79	202
Total Volume	169	228	397	268	313	581	485	285	770
% App. Total	42.6	57.4		46.1	53.9		63	37	
PHF	.880	.934	.954	.918	.807	.897	.898	.902	.948

County of San Diego
 N/S: West Lilac Road
 E/W: Covey Lane
 Weather: Clear

Groups Printed- Total Volume

Start Time	West Lilac Road Southbound				Covey Lane Westbound				West Lilac Road Northbound				Covey Lane Eastbound				Int. Total
	Left	Thru	Right	App. Total	Left	Thru	Right	App. Total	Left	Thru	Right	App. Total	Left	Thru	Right	App. Total	
07:00 AM	0	2	3	5	0	0	1	1	0	2	2	4	2	0	1	3	13
07:15 AM	1	2	0	3	0	0	0	0	4	1	0	5	2	0	6	8	16
07:30 AM	0	3	0	3	2	0	0	2	0	1	0	1	1	0	1	2	8
07:45 AM	0	6	1	7	1	0	2	3	1	4	1	6	2	0	1	3	19
Total	1	13	4	18	3	0	3	6	5	8	3	16	7	0	9	16	56
08:00 AM	2	3	0	5	1	0	0	1	2	1	0	3	2	0	2	4	13
08:15 AM	0	3	2	5	0	1	0	1	1	6	1	8	5	0	0	5	19
08:30 AM	0	4	0	4	1	0	0	1	1	2	2	5	2	0	2	4	14
08:45 AM	0	1	0	1	0	0	0	0	1	4	0	5	2	0	0	2	8
Total	2	11	2	15	2	1	0	3	5	13	3	21	11	0	4	15	54
Grand Total	3	24	6	33	5	1	3	9	10	21	6	37	18	0	13	31	110
Apprch %	9.1	72.7	18.2		55.6	11.1	33.3		27	56.8	16.2		58.1	0	41.9		
Total %	2.7	21.8	5.5	30	4.5	0.9	2.7	8.2	9.1	19.1	5.5	33.6	16.4	0	11.8	28.2	

Start Time	West Lilac Road Southbound				Covey Lane Westbound				West Lilac Road Northbound				Covey Lane Eastbound				Int. Total
	Left	Thru	Right	App. Total	Left	Thru	Right	App. Total	Left	Thru	Right	App. Total	Left	Thru	Right	App. Total	
Peak Hour Analysis From 07:00 AM to 08:45 AM - Peak 1 of 1																	
Peak Hour for Entire Intersection Begins at 07:45 AM																	
07:45 AM	0	6	1	7	1	0	2	3	1	4	1	6	2	0	1	3	19
08:00 AM	2	3	0	5	1	0	0	1	2	1	0	3	2	0	2	4	13
08:15 AM	0	3	2	5	0	1	0	1	1	6	1	8	5	0	0	5	19
08:30 AM	0	4	0	4	1	0	0	1	1	2	2	5	2	0	2	4	14
Total Volume	2	16	3	21	3	1	2	6	5	13	4	22	11	0	5	16	65
% App. Total	9.5	76.2	14.3		50	16.7	33.3		22.7	59.1	18.2		68.8	0	31.2		
PHF	.250	.667	.375	.750	.750	.250	.250	.500	.625	.542	.500	.688	.550	.000	.625	.800	.855

County of San Diego
 N/S: West Lilac Road
 E/W: Covey Lane
 Weather: Clear

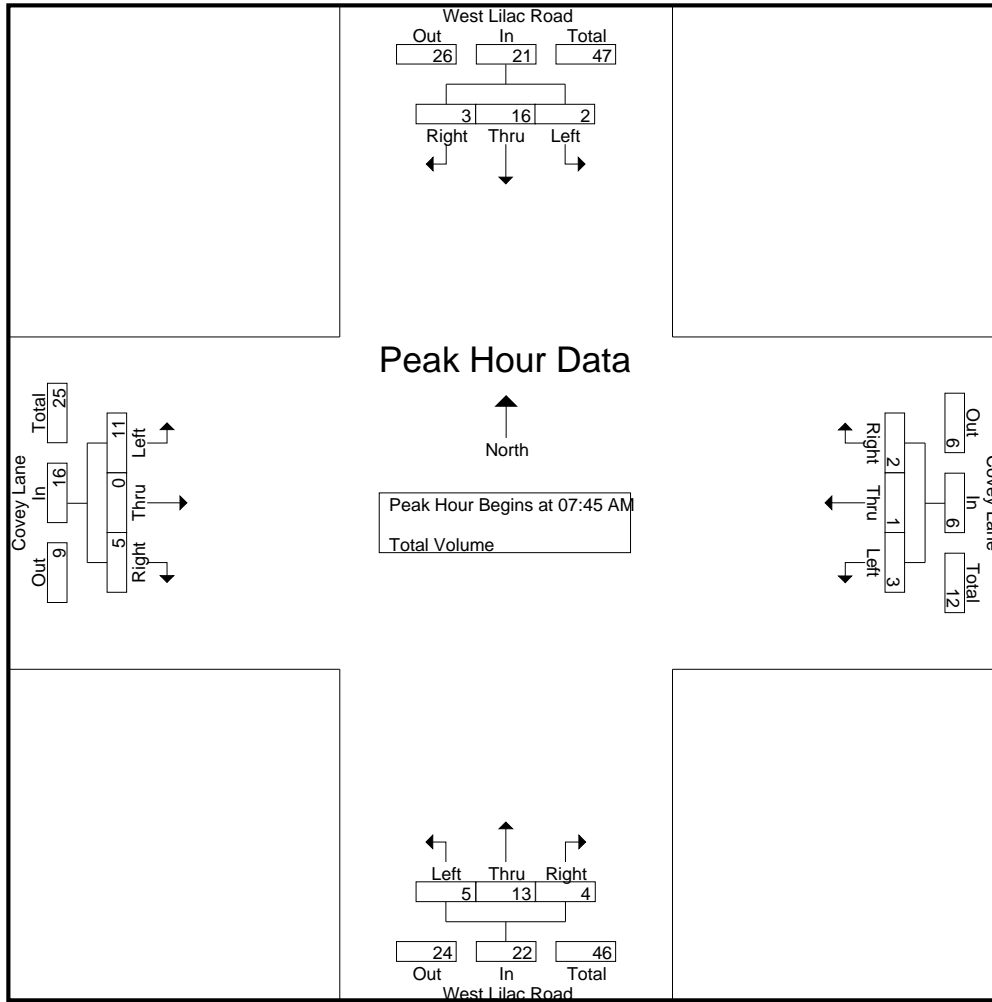

Peak Hour Analysis From 07:00 AM to 08:45 AM - Peak 1 of 1
 Peak Hour for Each Approach Begins at:

	07:45 AM				07:30 AM				07:45 AM				07:15 AM			
+0 mins.	0	6	1	7	2	0	0	2	1	4	1	6	2	0	6	8
+15 mins.	2	3	0	5	1	0	2	3	2	1	0	3	1	0	1	2
+30 mins.	0	3	2	5	1	0	0	1	1	6	1	8	2	0	1	3
+45 mins.	0	4	0	4	0	1	0	1	1	2	2	5	2	0	2	4
Total Volume	2	16	3	21	4	1	2	7	5	13	4	22	7	0	10	17
% App. Total	9.5	76.2	14.3		57.1	14.3	28.6		22.7	59.1	18.2		41.2	0	58.8	
PHF	.250	.667	.375	.750	.500	.250	.250	.583	.625	.542	.500	.688	.875	.000	.417	.531

County of San Diego
 N/S: West Lilac Road
 E/W: Covey Lane
 Weather: Clear

Groups Printed- Total Volume

Start Time	West Lilac Road Southbound				Covey Lane Westbound				West Lilac Road Northbound				Covey Lane Eastbound				Int. Total
	Left	Thru	Right	App. Total	Left	Thru	Right	App. Total	Left	Thru	Right	App. Total	Left	Thru	Right	App. Total	
04:00 PM	0	4	4	8	0	0	0	0	0	3	0	3	2	0	2	4	15
04:15 PM	1	0	4	5	0	0	1	1	1	6	1	8	5	0	1	6	20
04:30 PM	2	6	1	9	1	0	0	1	4	9	1	14	5	0	1	6	30
04:45 PM	2	4	3	9	3	0	0	3	4	4	1	9	0	0	2	2	23
Total	5	14	12	31	4	0	1	5	9	22	3	34	12	0	6	18	88
05:00 PM	1	4	2	7	0	0	1	1	3	3	1	7	1	1	1	3	18
05:15 PM	2	6	2	10	0	0	3	3	5	1	1	7	2	0	1	3	23
05:30 PM	0	5	1	6	0	1	1	2	1	1	0	2	2	0	1	3	13
05:45 PM	1	1	2	4	0	0	0	0	1	2	0	3	0	0	1	1	8
Total	4	16	7	27	0	1	5	6	10	7	2	19	5	1	4	10	62
Grand Total	9	30	19	58	4	1	6	11	19	29	5	53	17	1	10	28	150
Apprch %	15.5	51.7	32.8		36.4	9.1	54.5		35.8	54.7	9.4		60.7	3.6	35.7		
Total %	6	20	12.7	38.7	2.7	0.7	4	7.3	12.7	19.3	3.3	35.3	11.3	0.7	6.7	18.7	

Start Time	West Lilac Road Southbound				Covey Lane Westbound				West Lilac Road Northbound				Covey Lane Eastbound				Int. Total
	Left	Thru	Right	App. Total	Left	Thru	Right	App. Total	Left	Thru	Right	App. Total	Left	Thru	Right	App. Total	
Peak Hour Analysis From 04:00 PM to 05:45 PM - Peak 1 of 1																	
Peak Hour for Entire Intersection Begins at 04:30 PM																	
04:30 PM	2	6	1	9	1	0	0	1	4	9	1	14	5	0	1	6	30
04:45 PM	2	4	3	9	3	0	0	3	4	4	1	9	0	0	2	2	23
05:00 PM	1	4	2	7	0	0	1	1	3	3	1	7	1	1	1	3	18
05:15 PM	2	6	2	10	0	0	3	3	5	1	1	7	2	0	1	3	23
Total Volume	7	20	8	35	4	0	4	8	16	17	4	37	8	1	5	14	94
% App. Total	20	57.1	22.9		50	0	50		43.2	45.9	10.8		57.1	7.1	35.7		
PHF	.875	.833	.667	.875	.333	.000	.333	.667	.800	.472	1.00	.661	.400	.250	.625	.583	.783

County of San Diego
 N/S: West Lilac Road
 E/W: Covey Lane
 Weather: Clear

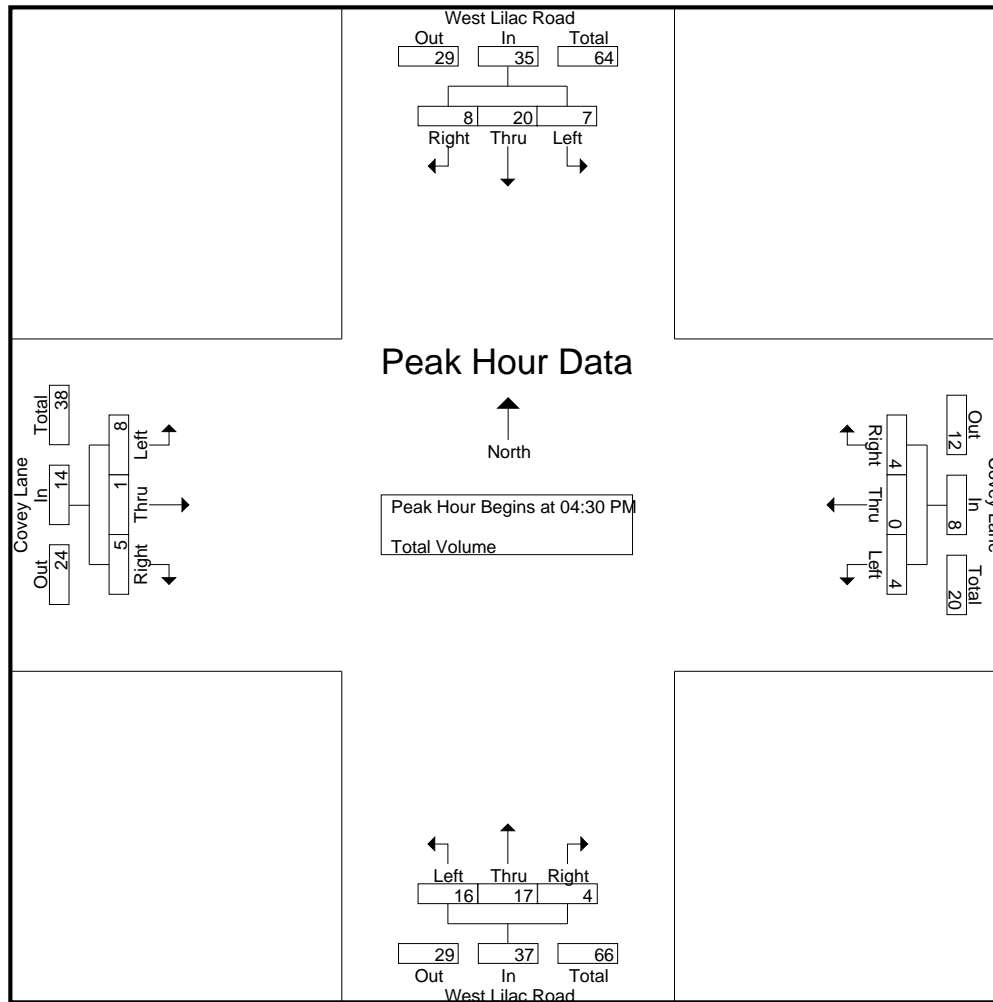

Peak Hour Analysis From 04:00 PM to 05:45 PM - Peak 1 of 1
 Peak Hour for Each Approach Begins at:

	04:30 PM				04:45 PM				04:15 PM				04:00 PM			
+0 mins.	2	6	1	9	3	0	0	3	1	6	1	8	2	0	2	4
+15 mins.	2	4	3	9	0	0	1	1	4	9	1	14	5	0	1	6
+30 mins.	1	4	2	7	0	0	3	3	4	4	1	9	5	0	1	6
+45 mins.	2	6	2	10	0	1	1	2	3	3	1	7	0	0	2	2
Total Volume	7	20	8	35	3	1	5	9	12	22	4	38	12	0	6	18
% App. Total	20	57.1	22.9		33.3	11.1	55.6		31.6	57.9	10.5		66.7	0	33.3	
PHF	.875	.833	.667	.875	.250	.250	.417	.750	.750	.611	1.000	.679	.600	.000	.750	.750

County of San Diego
 N/S: West Lilac Road/Circle R Drive
 E/W: West Lilac Road
 Weather: Clear

Groups Printed- Total Volume

Start Time	West Lilac Road Southbound			West Lilac Road Westbound			Circle R Drive Northbound			Int. Total
	Left	Thru	App. Total	Left	Right	App. Total	Thru	Right	App. Total	
07:00 AM	5	9	14	22	1	23	4	8	12	49
07:15 AM	3	7	10	12	1	13	3	8	11	34
07:30 AM	5	8	13	19	3	22	2	6	8	43
07:45 AM	6	10	16	10	4	14	4	8	12	42
Total	19	34	53	63	9	72	13	30	43	168
08:00 AM	5	4	9	17	1	18	4	4	8	35
08:15 AM	6	6	12	11	7	18	3	7	10	40
08:30 AM	1	6	7	10	4	14	2	4	6	27
08:45 AM	2	6	8	12	2	14	5	6	11	33
Total	14	22	36	50	14	64	14	21	35	135
Grand Total	33	56	89	113	23	136	27	51	78	303
Apprch %	37.1	62.9		83.1	16.9		34.6	65.4		
Total %	10.9	18.5	29.4	37.3	7.6	44.9	8.9	16.8	25.7	

Start Time	West Lilac Road Southbound			West Lilac Road Westbound			Circle R Drive Northbound			Int. Total
	Left	Thru	App. Total	Left	Right	App. Total	Thru	Right	App. Total	
07:00 AM	5	9	14	22	1	23	4	8	12	49
07:15 AM	3	7	10	12	1	13	3	8	11	34
07:30 AM	5	8	13	19	3	22	2	6	8	43
07:45 AM	6	10	16	10	4	14	4	8	12	42
Total Volume	19	34	53	63	9	72	13	30	43	168
% App. Total	35.8	64.2		87.5	12.5		30.2	69.8		
PHF	.792	.850	.828	.716	.563	.783	.813	.938	.896	.857

Peak Hour Analysis From 07:00 AM to 08:45 AM - Peak 1 of 1

Peak Hour for Entire Intersection Begins at 07:00 AM

County of San Diego
 N/S: West Lilac Road/Circle R Drive
 E/W: West Lilac Road
 Weather: Clear

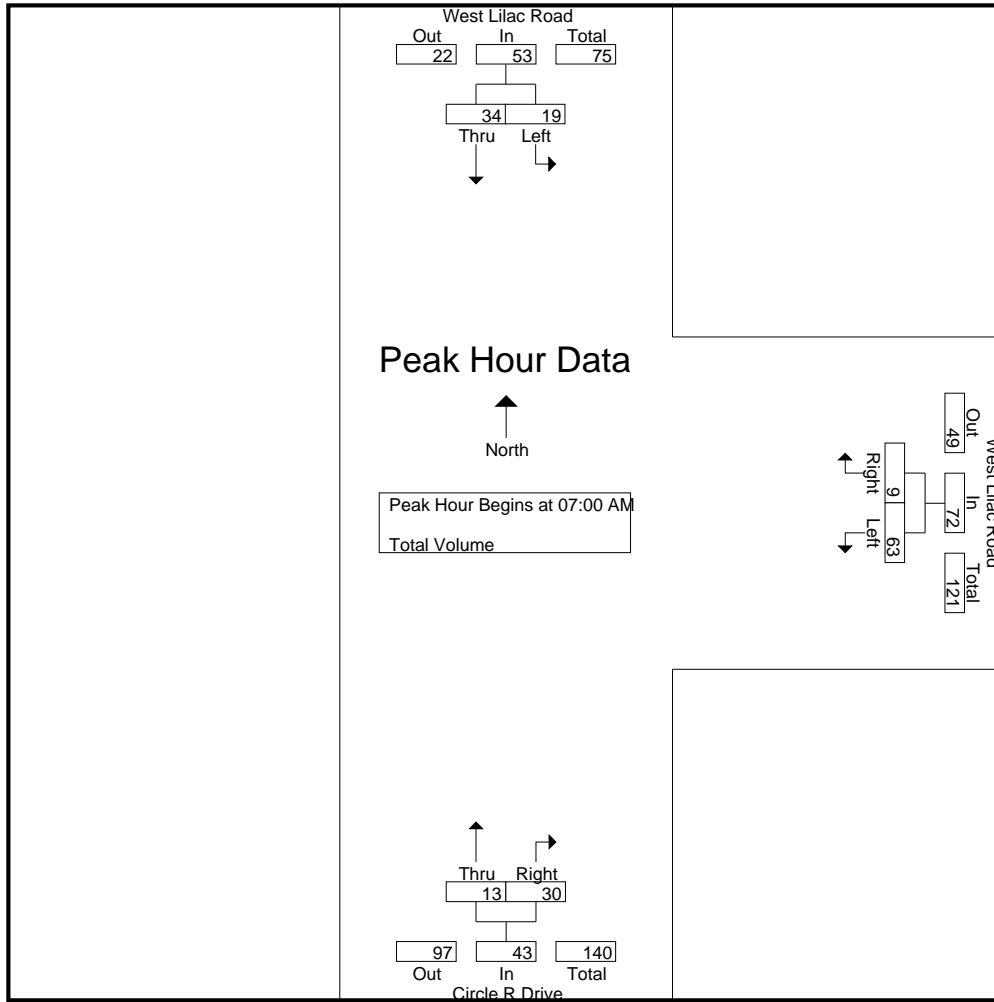

Peak Hour Analysis From 07:00 AM to 08:45 AM - Peak 1 of 1

Peak Hour for Each Approach Begins at:

	07:00 AM			07:00 AM			07:00 AM		
+0 mins.	5	9	14	22	1	23	4	8	12
+15 mins.	3	7	10	12	1	13	3	8	11
+30 mins.	5	8	13	19	3	22	2	6	8
+45 mins.	6	10	16	10	4	14	4	8	12
Total Volume	19	34	53	63	9	72	13	30	43
% App. Total	35.8	64.2		87.5	12.5		30.2	69.8	
PHF	.792	.850	.828	.716	.563	.783	.813	.938	.896

County of San Diego
 N/S: West Lilac Road/Circle R Drive
 E/W: West Lilac Road
 Weather: Clear

Groups Printed- Total Volume

Start Time	West Lilac Road Southbound			West Lilac Road Westbound			Circle R Drive Northbound			Int. Total
	Left	Thru	App. Total	Left	Right	App. Total	Thru	Right	App. Total	
04:00 PM	8	8	16	5	0	5	6	20	26	47
04:15 PM	4	4	8	8	5	13	6	12	18	39
04:30 PM	5	7	12	10	3	13	8	17	25	50
04:45 PM	8	12	20	5	3	8	8	19	27	55
Total	25	31	56	28	11	39	28	68	96	191
05:00 PM	3	5	8	8	0	8	9	19	28	44
05:15 PM	4	2	6	10	4	14	8	12	20	40
05:30 PM	4	3	7	13	3	16	9	17	26	49
05:45 PM	3	3	6	6	2	8	10	13	23	37
Total	14	13	27	37	9	46	36	61	97	170
Grand Total	39	44	83	65	20	85	64	129	193	361
Apprch %	47	53		76.5	23.5		33.2	66.8		
Total %	10.8	12.2	23	18	5.5	23.5	17.7	35.7	53.5	

Start Time	West Lilac Road Southbound			West Lilac Road Westbound			Circle R Drive Northbound			Int. Total
	Left	Thru	App. Total	Left	Right	App. Total	Thru	Right	App. Total	
04:00 PM	8	8	16	5	0	5	6	20	26	47
04:15 PM	4	4	8	8	5	13	6	12	18	39
04:30 PM	5	7	12	10	3	13	8	17	25	50
04:45 PM	8	12	20	5	3	8	8	19	27	55
Total Volume	25	31	56	28	11	39	28	68	96	191
% App. Total	44.6	55.4		71.8	28.2		29.2	70.8		
PHF	.781	.646	.700	.700	.550	.750	.875	.850	.889	.868

Peak Hour Analysis From 04:00 PM to 05:45 PM - Peak 1 of 1

Peak Hour for Entire Intersection Begins at 04:00 PM

County of San Diego
 N/S: West Lilac Road/Circle R Drive
 E/W: West Lilac Road
 Weather: Clear

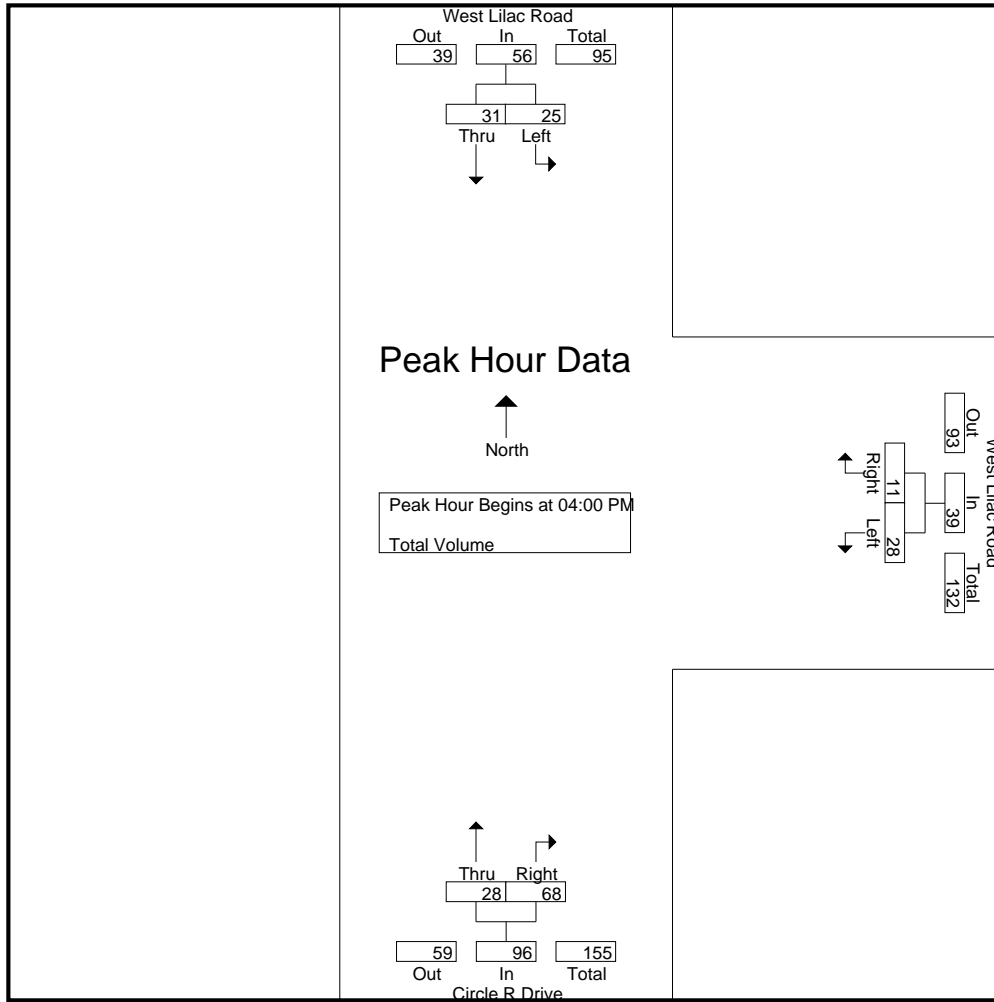

Peak Hour Analysis From 04:00 PM to 05:45 PM - Peak 1 of 1

Peak Hour for Each Approach Begins at:

	04:00 PM			04:45 PM			04:45 PM		
+0 mins.	8	8	16	5	3	8	8	19	27
+15 mins.	4	4	8	8	0	8	9	19	28
+30 mins.	5	7	12	10	4	14	8	12	20
+45 mins.	8	12	20	13	3	16	9	17	26
Total Volume	25	31	56	36	10	46	34	67	101
% App. Total	44.6	55.4		78.3	21.7		33.7	66.3	
PHF	.781	.646	.700	.692	.625	.719	.944	.882	.902

County of San Diego
 N/S: Lilac Road
 E/W: West Lilac Road
 Weather: Clear

File Name : 14_CSD_Lilac_W Lilac AM
 Site Code : 00318811
 Start Date : 11/8/2018
 Page No : 1

Groups Printed- Total Volume

Start Time	Lilac Road Southbound			Lilac Road Northbound			West Lilac Road Eastbound			Int. Total
	Thru	Right	App. Total	Left	Thru	App. Total	Left	Right	App. Total	
07:00 AM	20	11	31	3	5	8	4	10	14	53
07:15 AM	17	8	25	2	5	7	2	11	13	45
07:30 AM	25	15	40	5	18	23	3	11	14	77
07:45 AM	21	11	32	5	13	18	0	16	16	66
Total	83	45	128	15	41	56	9	48	57	241
08:00 AM	24	12	36	3	11	14	2	12	14	64
08:15 AM	18	3	21	8	12	20	3	10	13	54
08:30 AM	6	5	11	9	15	24	1	7	8	43
08:45 AM	17	11	28	4	7	11	2	5	7	46
Total	65	31	96	24	45	69	8	34	42	207
Grand Total	148	76	224	39	86	125	17	82	99	448
Apprch %	66.1	33.9		31.2	68.8		17.2	82.8		
Total %	33	17	50	8.7	19.2	27.9	3.8	18.3	22.1	

Start Time	Lilac Road Southbound			Lilac Road Northbound			West Lilac Road Eastbound			Int. Total
	Thru	Right	App. Total	Left	Thru	App. Total	Left	Right	App. Total	
07:30 AM	25	15	40	5	18	23	3	11	14	77
07:45 AM	21	11	32	5	13	18	0	16	16	66
08:00 AM	24	12	36	3	11	14	2	12	14	64
08:15 AM	18	3	21	8	12	20	3	10	13	54
Total Volume	88	41	129	21	54	75	8	49	57	261
% App. Total	68.2	31.8		28	72		14	86		
PHF	.880	.683	.806	.656	.750	.815	.667	.766	.891	.847

Peak Hour Analysis From 07:00 AM to 08:45 AM - Peak 1 of 1

Peak Hour for Entire Intersection Begins at 07:30 AM

County of San Diego
 N/S: Lilac Road
 E/W: West Lilac Road
 Weather: Clear

File Name : 14_CSD_Lilac_W Lilac AM
 Site Code : 00318811
 Start Date : 11/8/2018
 Page No : 2

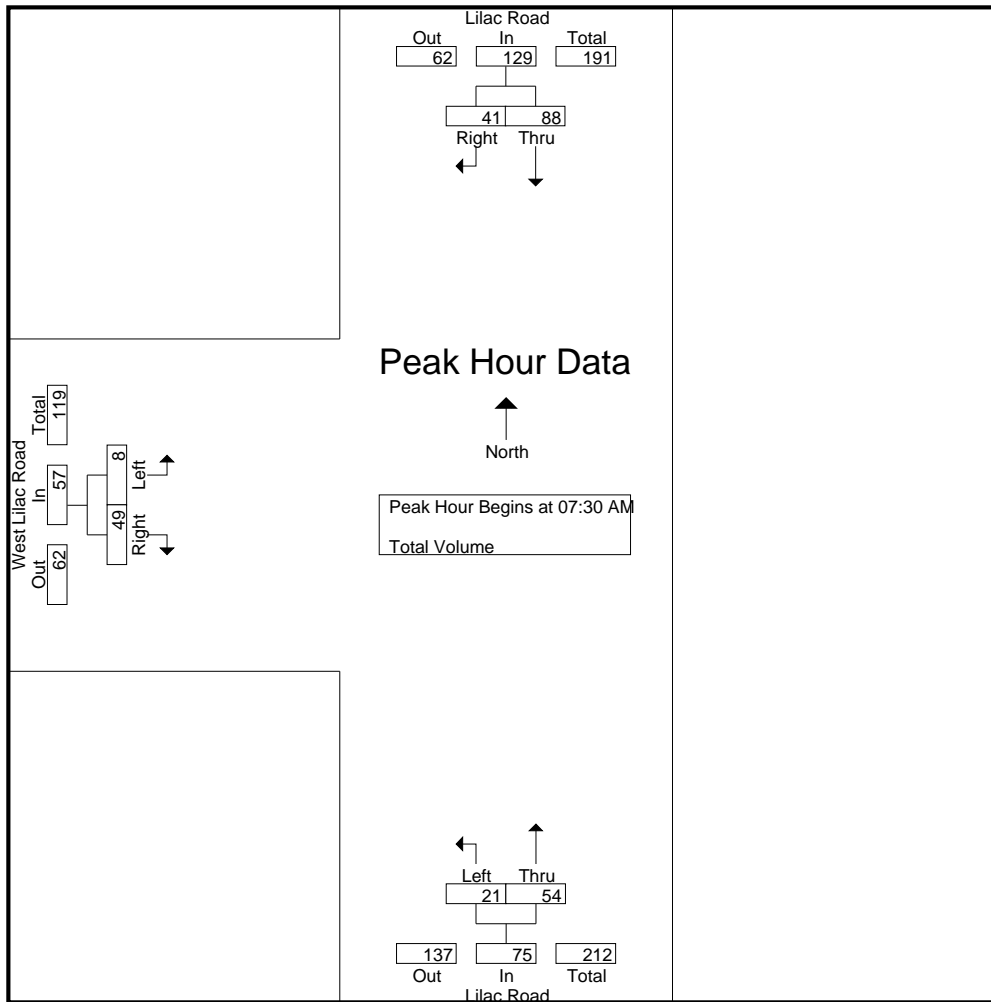

Peak Hour Analysis From 07:00 AM to 08:45 AM - Peak 1 of 1
 Peak Hour for Each Approach Begins at:

	07:15 AM			07:45 AM			07:00 AM		
+0 mins.	17	8	25	5	13	18	4	10	14
+15 mins.	25	15	40	3	11	14	2	11	13
+30 mins.	21	11	32	8	12	20	3	11	14
+45 mins.	24	12	36	9	15	24	0	16	16
Total Volume	87	46	133	25	51	76	9	48	57
% App. Total	65.4	34.6		32.9	67.1		15.8	84.2	
PHF	.870	.767	.831	.694	.850	.792	.563	.750	.891

County of San Diego
 N/S: Lilac Road
 E/W: West Lilac Road
 Weather: Clear

File Name : 14_CSD_Lilac_W Lilac PM
 Site Code : 00318811
 Start Date : 11/8/2018
 Page No : 1

Groups Printed- Total Volume

Start Time	Lilac Road Southbound			Lilac Road Northbound			West Lilac Road Eastbound			Int. Total
	Thru	Right	App. Total	Left	Thru	App. Total	Left	Right	App. Total	
04:00 PM	15	2	17	2	17	19	12	8	20	56
04:15 PM	18	6	24	12	32	44	10	11	21	89
04:30 PM	20	6	26	5	24	29	12	9	21	76
04:45 PM	19	3	22	7	18	25	13	11	24	71
Total	72	17	89	26	91	117	47	39	86	292
05:00 PM	12	3	15	12	30	42	8	6	14	71
05:15 PM	20	6	26	10	16	26	11	4	15	67
05:30 PM	10	7	17	7	23	30	10	4	14	61
05:45 PM	14	3	17	7	18	25	8	7	15	57
Total	56	19	75	36	87	123	37	21	58	256
Grand Total	128	36	164	62	178	240	84	60	144	548
Apprch %	78	22		25.8	74.2		58.3	41.7		
Total %	23.4	6.6	29.9	11.3	32.5	43.8	15.3	10.9	26.3	

Start Time	Lilac Road Southbound			Lilac Road Northbound			West Lilac Road Eastbound			Int. Total
	Thru	Right	App. Total	Left	Thru	App. Total	Left	Right	App. Total	
04:15 PM	18	6	24	12	32	44	10	11	21	89
04:30 PM	20	6	26	5	24	29	12	9	21	76
04:45 PM	19	3	22	7	18	25	13	11	24	71
05:00 PM	12	3	15	12	30	42	8	6	14	71
Total Volume	69	18	87	36	104	140	43	37	80	307
% App. Total	79.3	20.7		25.7	74.3		53.8	46.2		
PHF	.863	.750	.837	.750	.813	.795	.827	.841	.833	.862

Peak Hour Analysis From 04:00 PM to 05:45 PM - Peak 1 of 1

Peak Hour for Entire Intersection Begins at 04:15 PM

County of San Diego
 N/S: Lilac Road
 E/W: West Lilac Road
 Weather: Clear

File Name : 14_CSD_Lilac_W Lilac PM
 Site Code : 00318811
 Start Date : 11/8/2018
 Page No : 2

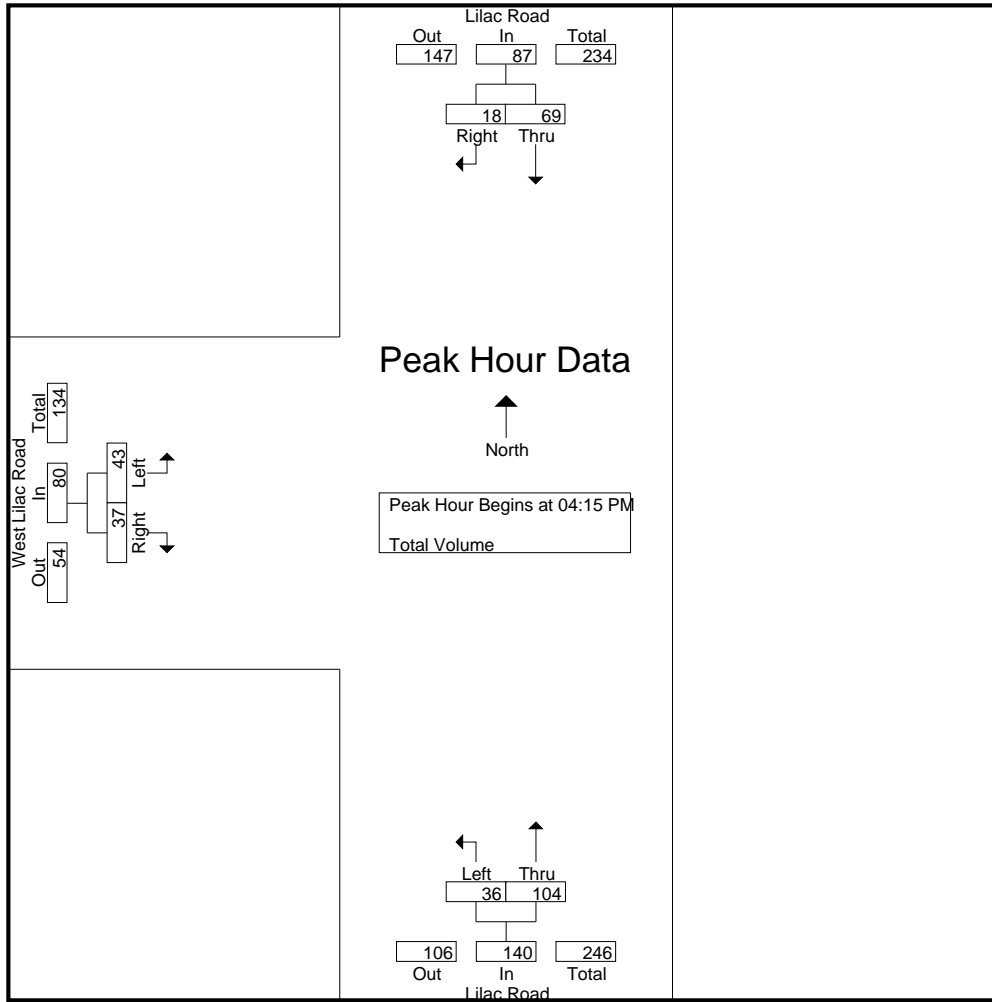

Peak Hour Analysis From 04:00 PM to 05:45 PM - Peak 1 of 1
 Peak Hour for Each Approach Begins at:

	04:00 PM			04:15 PM			04:00 PM		
+0 mins.	15	2	17	12	32	44	12	8	20
+15 mins.	18	6	24	5	24	29	10	11	21
+30 mins.	20	6	26	7	18	25	12	9	21
+45 mins.	19	3	22	12	30	42	13	11	24
Total Volume	72	17	89	36	104	140	47	39	86
% App. Total	80.9	19.1		25.7	74.3		54.7	45.3	
PHF	.900	.708	.856	.750	.813	.795	.904	.886	.896

County of San Diego
 N/S: Lilac Road
 E/W: Old Castle Road/Lilac Road
 Weather: Clear

Groups Printed- Total Volume

Start Time	Lilac Road Southbound			Lilac Road Westbound			Old Castle Road Eastbound			Int. Total
	Left	Right	App. Total	Thru	Right	App. Total	Left	Thru	App. Total	
07:00 AM	29	8	37	55	8	63	6	40	46	146
07:15 AM	27	13	40	89	24	113	16	40	56	209
07:30 AM	46	25	71	69	42	111	16	50	66	248
07:45 AM	62	25	87	54	41	95	17	30	47	229
Total	164	71	235	267	115	382	55	160	215	832
08:00 AM	45	27	72	51	41	92	22	36	58	222
08:15 AM	47	14	61	68	29	97	7	36	43	201
08:30 AM	24	10	34	49	23	72	5	33	38	144
08:45 AM	28	13	41	39	13	52	3	25	28	121
Total	144	64	208	207	106	313	37	130	167	688
Grand Total	308	135	443	474	221	695	92	290	382	1520
Apprch %	69.5	30.5		68.2	31.8		24.1	75.9		
Total %	20.3	8.9	29.1	31.2	14.5	45.7	6.1	19.1	25.1	

Start Time	Lilac Road Southbound			Lilac Road Westbound			Old Castle Road Eastbound			Int. Total
	Left	Right	App. Total	Thru	Right	App. Total	Left	Thru	App. Total	
07:15 AM	27	13	40	89	24	113	16	40	56	209
07:30 AM	46	25	71	69	42	111	16	50	66	248
07:45 AM	62	25	87	54	41	95	17	30	47	229
08:00 AM	45	27	72	51	41	92	22	36	58	222
Total Volume	180	90	270	263	148	411	71	156	227	908
% App. Total	66.7	33.3		64	36		31.3	68.7		
PHF	.726	.833	.776	.739	.881	.909	.807	.780	.860	.915

Peak Hour Analysis From 07:00 AM to 08:45 AM - Peak 1 of 1

Peak Hour for Entire Intersection Begins at 07:15 AM

County of San Diego
 N/S: Lilac Road
 E/W: Old Castle Road/Lilac Road
 Weather: Clear

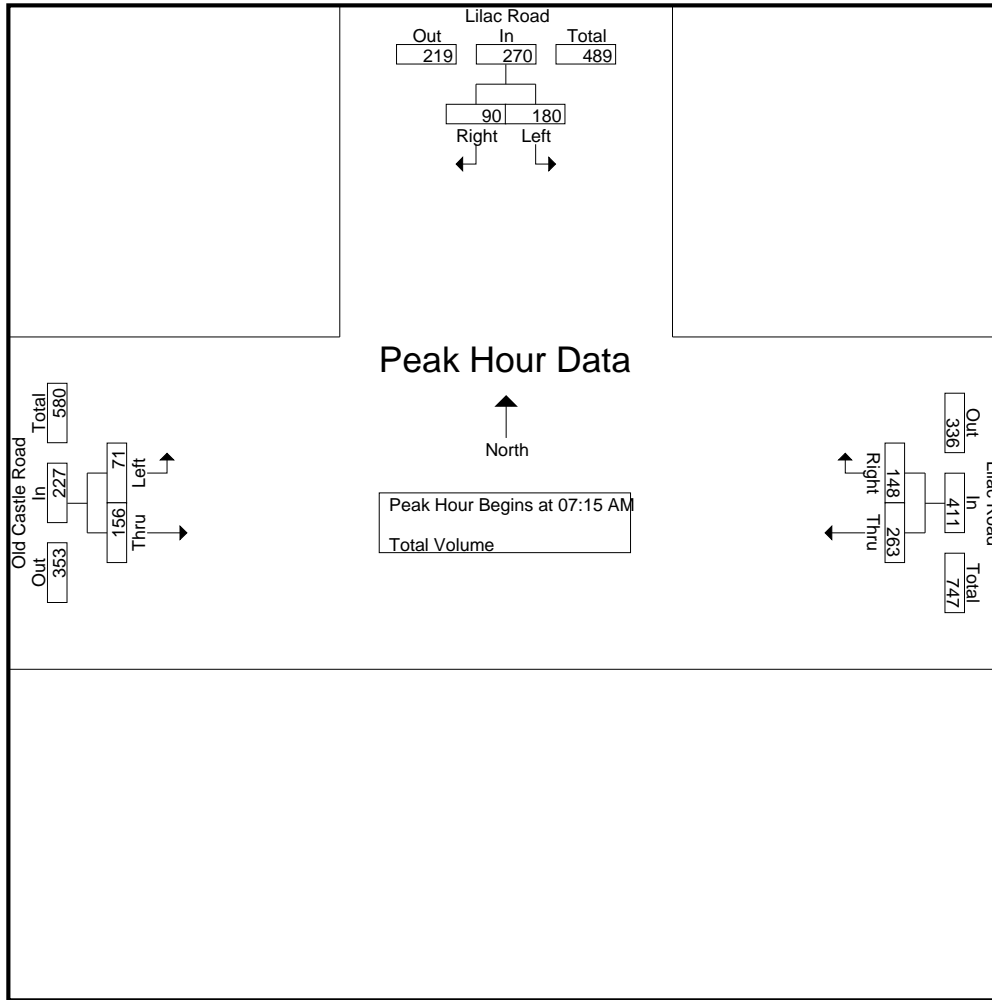

Peak Hour Analysis From 07:00 AM to 08:45 AM - Peak 1 of 1
 Peak Hour for Each Approach Begins at:

	07:30 AM			07:15 AM			07:15 AM		
+0 mins.	46	25	71	89	24	113	16	40	56
+15 mins.	62	25	87	69	42	111	16	50	66
+30 mins.	45	27	72	54	41	95	17	30	47
+45 mins.	47	14	61	51	41	92	22	36	58
Total Volume	200	91	291	263	148	411	71	156	227
% App. Total	68.7	31.3		64	36		31.3	68.7	
PHF	.806	.843	.836	.739	.881	.909	.807	.780	.860

County of San Diego
 N/S: Lilac Road
 E/W: Old Castle Road/Lilac Road
 Weather: Clear

Groups Printed- Total Volume

Start Time	Lilac Road Southbound			Lilac Road Westbound			Old Castle Road Eastbound			Int. Total
	Left	Right	App. Total	Thru	Right	App. Total	Left	Thru	App. Total	
04:00 PM	22	4	26	42	31	73	11	81	92	191
04:15 PM	35	4	39	49	33	82	17	74	91	212
04:30 PM	37	3	40	46	36	82	15	75	90	212
04:45 PM	32	8	40	56	30	86	13	80	93	219
Total	126	19	145	193	130	323	56	310	366	834
05:00 PM	25	3	28	45	37	82	13	87	100	210
05:15 PM	24	10	34	53	35	88	17	69	86	208
05:30 PM	18	2	20	39	30	69	11	59	70	159
05:45 PM	17	6	23	36	21	57	15	78	93	173
Total	84	21	105	173	123	296	56	293	349	750
Grand Total	210	40	250	366	253	619	112	603	715	1584
Apprch %	84	16		59.1	40.9		15.7	84.3		
Total %	13.3	2.5	15.8	23.1	16	39.1	7.1	38.1	45.1	

Start Time	Lilac Road Southbound			Lilac Road Westbound			Old Castle Road Eastbound			Int. Total
	Left	Right	App. Total	Thru	Right	App. Total	Left	Thru	App. Total	
04:15 PM	35	4	39	49	33	82	17	74	91	212
04:30 PM	37	3	40	46	36	82	15	75	90	212
04:45 PM	32	8	40	56	30	86	13	80	93	219
05:00 PM	25	3	28	45	37	82	13	87	100	210
Total Volume	129	18	147	196	136	332	58	316	374	853
% App. Total	87.8	12.2		59	41		15.5	84.5		
PHF	.872	.563	.919	.875	.919	.965	.853	.908	.935	.974

Peak Hour Analysis From 04:00 PM to 05:45 PM - Peak 1 of 1

Peak Hour for Entire Intersection Begins at 04:15 PM

County of San Diego
 N/S: Lilac Road
 E/W: Old Castle Road/Lilac Road
 Weather: Clear

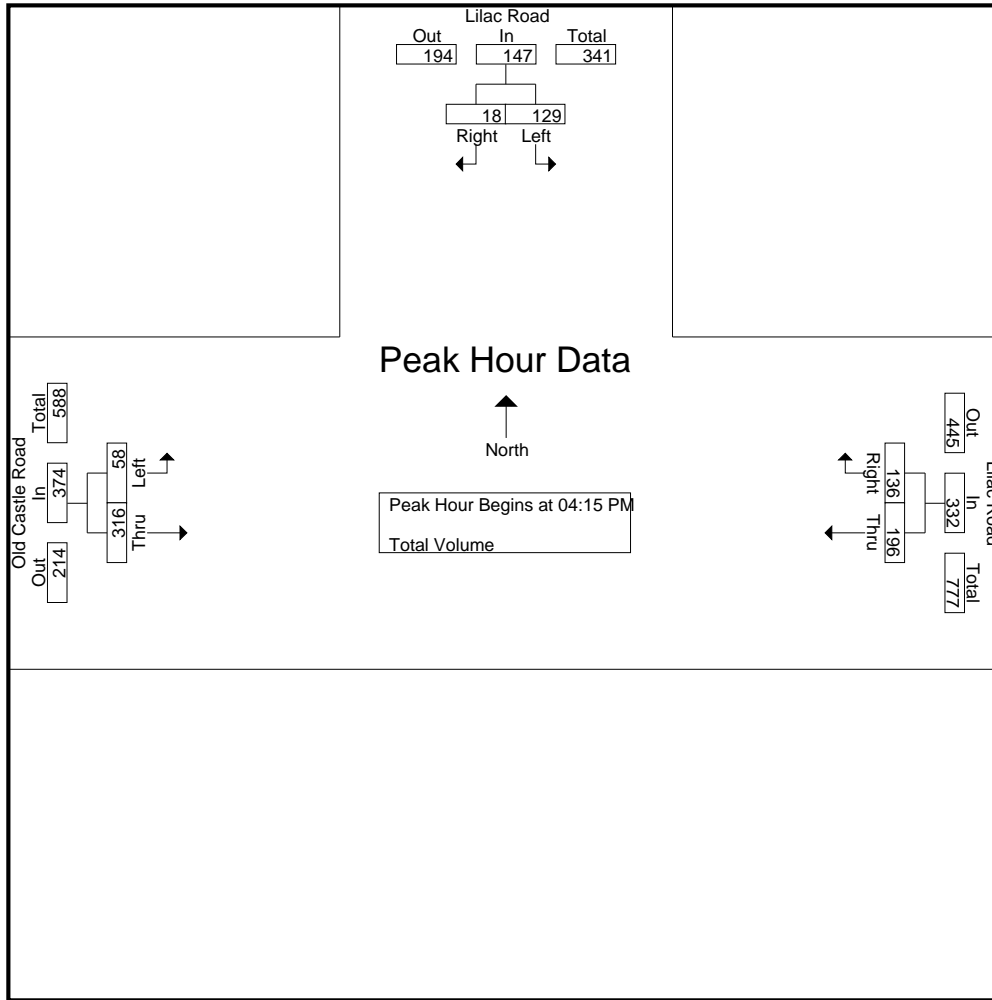

Peak Hour Analysis From 04:00 PM to 05:45 PM - Peak 1 of 1
 Peak Hour for Each Approach Begins at:

	04:15 PM			04:30 PM			04:45 PM		
+0 mins.	35	4	39	46	36	82	17	74	91
+15 mins.	37	3	40	56	30	86	15	75	90
+30 mins.	32	8	40	45	37	82	13	80	93
+45 mins.	25	3	28	53	35	88	13	87	100
Total Volume	129	18	147	200	138	338	58	316	374
% App. Total	87.8	12.2		59.2	40.8		15.5	84.5	
PHF	.872	.563	.919	.893	.932	.960	.853	.908	.935

Counts Unlimited, Inc.

County of San Diego
 Dulin Road
 B/ Old Highway 395 - Lake Circle Drive
 24 Hour Directional Volume Count

PO Box 1178
 Corona, CA 92878
 Phone: 951-268-6268
 email: counts@countsunlimited.com

CSD001
 Site Code: 003-18811

Start Time	08-Nov-18 Thu	Eastbound		Hour Totals		Westbound		Hour Totals		Combined Totals	
		Morning	Afternoon	Morning	Afternoon	Morning	Afternoon	Morning	Afternoon	Morning	Afternoon
12:00		8	20			3	44				
12:15		4	22			1	31				
12:30		8	22			2	42				
12:45		1	23	21	87	1	33	7	150	28	237
01:00		0	38			1	24				
01:15		1	52			1	24				
01:30		3	27			0	26				
01:45		2	39	6	156	2	30	4	104	10	260
02:00		1	46			0	34				
02:15		1	46			1	40				
02:30		2	41			1	21				
02:45		1	46	5	179	1	32	3	127	8	306
03:00		0	37			1	19				
03:15		2	35			5	22				
03:30		0	54			3	27				
03:45		2	51	4	177	4	16	13	84	17	261
04:00		2	44			6	24				
04:15		0	48			5	24				
04:30		0	56			14	24				
04:45		0	62	2	210	10	24	35	96	37	306
05:00		2	52			13	26				
05:15		4	56			34	26				
05:30		5	64			37	32				
05:45		4	66	15	238	45	30	129	114	144	352
06:00		6	64			59	22				
06:15		7	53			64	28				
06:30		9	60			62	16				
06:45		10	38	32	215	64	14	249	80	281	295
07:00		5	43			83	16				
07:15		7	33			108	15				
07:30		13	34			101	10				
07:45		34	22	59	132	44	6	336	47	395	179
08:00		36	23			51	7				
08:15		38	30			54	3				
08:30		19	23			46	10				
08:45		24	24	117	100	35	8	186	28	303	128
09:00		16	24			21	6				
09:15		16	18			31	7				
09:30		12	20			38	5				
09:45		15	18	59	80	29	10	119	28	178	108
10:00		18	22			18	1				
10:15		15	10			26	5				
10:30		14	7			22	2				
10:45		12	4	59	43	21	1	87	9	146	52
11:00		13	9			26	1				
11:15		28	6			25	1				
11:30		26	5			32	1				
11:45		22	8	89	28	22	2	105	5	194	33
Total		468	1645	468	1645	1273	872	1273	872	1741	2517
Combined Total		2113		2113		2145		2145		4258	
AM Peak	-	07:45	-	-	-	06:45	-	-	-	-	-
Vol.	-	127	-	-	-	356	-	-	-	-	-
P.H.F.	-	0.836	-	-	-	0.824	-	-	-	-	-
PM Peak	-	-	05:15	-	-	-	12:00	-	-	-	-
Vol.	-	-	250	-	-	-	150	-	-	-	-
P.H.F.	-	-	0.947	-	-	-	0.852	-	-	-	-
Percentage		22.1%	77.9%			59.3%	40.7%				
ADT/AADT		ADT 4,258		AADT 4,258							

Counts Unlimited, Inc.

County of San Diego
 West Lilac Road
 B/ Camino del Rey - Vessels Ranch Road
 24 Hour Directional Volume Count

PO Box 1178
 Corona, CA 92878
 Phone: 951-268-6268
 email: counts@countsunlimited.com

CSD002
 Site Code: 003-18811

Start Time	08-Nov-18 Thu	Eastbound		Hour Totals		Westbound		Hour Totals		Combined Totals	
		Morning	Afternoon	Morning	Afternoon	Morning	Afternoon	Morning	Afternoon	Morning	Afternoon
12:00		1	22			0	15				
12:15		1	19			2	12				
12:30		0	18			3	24				
12:45		1	49	3	108	0	35	5	86	8	194
01:00		2	82			0	31				
01:15		0	48			0	24				
01:30		0	30			0	21				
01:45		0	30	2	190	0	98	0	174	2	364
02:00		0	39			0	41				
02:15		0	26			1	60				
02:30		0	21			0	32				
02:45		0	16	0	102	0	14	1	147	1	249
03:00		0	17			0	18				
03:15		0	22			0	17				
03:30		0	19			0	22				
03:45		0	18	0	76	0	26	0	83	0	159
04:00		1	30			0	24				
04:15		1	26			0	25				
04:30		1	34			1	31				
04:45		0	25	3	115	6	22	7	102	10	217
05:00		2	24			3	22				
05:15		2	18			4	23				
05:30		10	18			6	45				
05:45		8	20	22	80	4	36	17	126	39	206
06:00		13	14			8	9				
06:15		10	14			9	13				
06:30		14	9			16	14				
06:45		18	11	55	48	16	6	49	42	104	90
07:00		19	7			22	14				
07:15		27	14			36	11				
07:30		64	7			70	6				
07:45		130	11	240	39	34	4	162	35	402	74
08:00		95	13			58	2				
08:15		26	8			82	4				
08:30		29	6			32	1				
08:45		8	11	158	38	20	10	192	17	350	55
09:00		10	4			18	2				
09:15		14	6			4	4				
09:30		17	5			10	5				
09:45		7	4	48	19	18	2	50	13	98	32
10:00		21	5			4	2				
10:15		12	2			4	3				
10:30		17	1			21	1				
10:45		18	2	68	10	22	0	51	6	119	16
11:00		14	2			15	2				
11:15		16	0			15	2				
11:30		16	1			16	0				
11:45		10	2	56	5	28	0	74	4	130	9
Total		655	830	655	830	608	835	608	835	1263	1665
Combined Total		1485		1485		1443		1443		2928	
AM Peak	-	07:15	-	-	-	07:30	-	-	-	-	-
Vol.	-	316	-	-	-	244	-	-	-	-	-
P.H.F.	-	0.608	-	-	-	0.744	-	-	-	-	-
PM Peak	-	-	00:45	-	-	-	01:45	-	-	-	-
Vol.	-	-	209	-	-	-	231	-	-	-	-
P.H.F.	-	-	0.637	-	-	-	0.589	-	-	-	-
Percentage		44.1%	55.9%			42.1%	57.9%				
ADT/AADT		ADT 2,928		AADT 2,928							

Counts Unlimited, Inc.

County of San Diego
 West Lilac Road
 B/ Interstate 15 - Standel Lane
 24 Hour Directional Volume Count

PO Box 1178
 Corona, CA 92878
 Phone: 951-268-6268
 email: counts@countsunlimited.com

CSD005
 Site Code: 003-18811

Start Time	08-Nov-18 Thu	Eastbound		Hour Totals		Westbound		Hour Totals		Combined Totals	
		Morning	Afternoon	Morning	Afternoon	Morning	Afternoon	Morning	Afternoon	Morning	Afternoon
12:00		3	5			0	15				
12:15		2	6			0	15				
12:30		1	9			1	10				
12:45		1	5	7	25	1	6	2	46	9	71
01:00		1	5			0	6				
01:15		0	11			0	10				
01:30		0	11			0	12				
01:45		0	14	1	41	0	11	0	39	1	80
02:00		0	22			0	10				
02:15		0	18			1	9				
02:30		0	20			0	10				
02:45		0	19	0	79	0	7	1	36	1	115
03:00		0	20			1	12				
03:15		2	26			1	10				
03:30		1	34			0	16				
03:45		0	26	3	106	0	14	2	52	5	158
04:00		0	20			2	10				
04:15		0	18			4	18				
04:30		1	16			3	12				
04:45		0	14	1	68	4	10	13	50	14	118
05:00		1	16			3	17				
05:15		1	24			2	10				
05:30		10	13			10	15				
05:45		8	14	20	67	18	10	33	52	53	119
06:00		10	18			16	6				
06:15		5	16			9	8				
06:30		14	10			9	3				
06:45		11	10	40	54	19	7	53	24	93	78
07:00		5	10			23	4				
07:15		4	6			9	4				
07:30		10	6			16	11				
07:45		13	10	32	32	12	3	60	22	92	54
08:00		11	10			10	9				
08:15		16	8			16	14				
08:30		6	5			22	6				
08:45		8	7	41	30	11	12	59	41	100	71
09:00		8	8			10	6				
09:15		12	6			12	5				
09:30		11	7			12	6				
09:45		10	4	41	25	14	12	48	29	89	54
10:00		10	6			9	8				
10:15		6	4			7	10				
10:30		13	6			12	6				
10:45		8	4	37	20	15	8	43	32	80	52
11:00		7	6			16	3				
11:15		10	0			14	1				
11:30		14	1			9	0				
11:45		8	1	39	8	9	0	48	4	87	12
Total		262	555	262	555	362	427	362	427	624	982
Combined Total		817		817		789		789		1606	
AM Peak	-	07:30	-	-	-	06:45	-	-	-	-	-
Vol.	-	50	-	-	-	67	-	-	-	-	-
P.H.F.	-	0.781	-	-	-	0.728	-	-	-	-	-
PM Peak	-	-	03:00	-	-	-	03:30	-	-	-	-
Vol.	-	-	106	-	-	-	58	-	-	-	-
P.H.F.	-	-	0.779	-	-	-	0.806	-	-	-	-
Percentage		32.1%	67.9%			45.9%	54.1%				
ADT/AADT		ADT 1,606		AADT 1,606							

Counts Unlimited, Inc.

County of San Diego
 West Lilac Road
 B/ Circle R Drive - Lal Bagh Lane
 24 Hour Directional Volume Count

PO Box 1178
 Corona, CA 92878
 Phone: 951-268-6268
 email: counts@countsunlimited.com

CSD006
 Site Code: 003-18811

Start Time	08-Nov-18 Thu	Northbound		Hour Totals		Southbound		Hour Totals		Combined Totals	
		Morning	Afternoon	Morning	Afternoon	Morning	Afternoon	Morning	Afternoon	Morning	Afternoon
12:00		0	16			0	4				
12:15		1	8			0	11				
12:30		0	4			0	6				
12:45		0	10	1	38	0	9	0	30	1	68
01:00		0	3			0	8				
01:15		2	7			0	11				
01:30		0	5			0	7				
01:45		1	7	3	22	1	12	1	38	4	60
02:00		0	8			0	10				
02:15		1	13			0	12				
02:30		0	8			0	12				
02:45		0	10	1	39	0	8	0	42	1	81
03:00		0	12			0	8				
03:15		0	13			0	2				
03:30		0	8			0	9				
03:45		0	2	0	35	1	10	1	29	1	64
04:00		0	8			1	16				
04:15		1	12			2	8				
04:30		1	12			2	13				
04:45		0	12	2	44	0	18	5	55	7	99
05:00		0	9			2	8				
05:15		2	12			6	6				
05:30		10	16			7	6				
05:45		10	13	22	50	7	6	22	26	44	76
06:00		7	12			12	3				
06:15		4	8			7	5				
06:30		5	9			15	4				
06:45		8	6	24	35	15	5	49	17	73	52
07:00		5	6			10	2				
07:15		4	5			12	0				
07:30		7	3			13	4				
07:45		6	3	22	17	12	1	47	7	69	24
08:00		4	1			10	2				
08:15		10	5			10	1				
08:30		6	6			10	0				
08:45		8	3	28	15	5	7	35	10	63	25
09:00		4	0			7	1				
09:15		4	4			3	0				
09:30		2	3			10	2				
09:45		3	8	13	15	7	1	27	4	40	19
10:00		6	2			6	1				
10:15		6	1			4	0				
10:30		2	2			9	1				
10:45		2	1	16	6	7	1	26	3	42	9
11:00		14	2			10	1				
11:15		6	2			10	1				
11:30		7	3			12	0				
11:45		13	0	40	7	7	0	39	2	79	9
Total		172	323	172	323	252	263	252	263	424	586
Combined Total		495		495		515		515		1010	
AM Peak	-	11:00	-	-	-	06:30	-	-	-	-	-
Vol.	-	40	-	-	-	52	-	-	-	-	-
P.H.F.		0.714				0.867					
PM Peak	-	-	05:15	-	-	-	04:00	-	-	-	-
Vol.	-	-	53	-	-	-	55	-	-	-	-
P.H.F.			0.828				0.764				
Percentage		34.7%	65.3%			48.9%	51.1%				
ADT/AADT		ADT 1,010		AADT 1,010							

Counts Unlimited, Inc.

County of San Diego
 West Lilac Road
 B/ Diaz Road - North Berry Road
 24 Hour Directional Volume Count

PO Box 1178
 Corona, CA 92878
 Phone: 951-268-6268
 email: counts@countsunlimited.com

CSD007
 Site Code: 003-18811

Start Time	08-Nov-18 Thu	Eastbound		Hour Totals		Westbound		Hour Totals		Combined Totals	
		Morning	Afternoon	Morning	Afternoon	Morning	Afternoon	Morning	Afternoon	Morning	Afternoon
12:00		0	8			0	16				
12:15		1	7			1	11				
12:30		1	5			1	9				
12:45		0	7	2	27	0	6	2	42	4	69
01:00		0	14			0	3				
01:15		0	8			1	11				
01:30		1	14			1	7				
01:45		0	9	1	45	0	7	2	28	3	73
02:00		0	18			0	10				
02:15		0	15			1	12				
02:30		0	5			0	11				
02:45		0	15	0	53	0	12	1	45	1	98
03:00		1	6			0	6				
03:15		0	13			0	12				
03:30		1	15			0	15				
03:45		0	20	2	54	1	5	1	38	3	92
04:00		0	19			3	2				
04:15		0	20			1	10				
04:30		1	23			5	12				
04:45		1	23	2	85	3	10	12	34	14	119
05:00		0	21			7	11				
05:15		7	15			8	8				
05:30		4	18			16	14				
05:45		5	16	16	70	21	10	52	43	68	113
06:00		6	22			17	5				
06:15		5	9			17	2				
06:30		6	6			7	5				
06:45		5	11	22	48	19	2	60	14	82	62
07:00		14	7			15	4				
07:15		11	5			8	5				
07:30		12	5			22	3				
07:45		13	9	50	26	17	4	62	16	112	42
08:00		12	4			16	4				
08:15		10	10			12	4				
08:30		6	5			12	4				
08:45		4	8	32	27	16	2	56	14	88	41
09:00		8	4			11	1				
09:15		2	5			10	1				
09:30		6	7			10	1				
09:45		5	5	21	21	7	2	38	5	59	26
10:00		4	2			5	2				
10:15		8	3			10	2				
10:30		10	5			10	1				
10:45		11	0	33	10	5	0	30	5	63	15
11:00		9	6			15	1				
11:15		11	1			6	0				
11:30		9	0			16	1				
11:45		8	0	37	7	20	1	57	3	94	10
Total		218	473	218	473	373	287	373	287	591	760
Combined Total		691		691		660		660		1351	
AM Peak	-	07:00	-	-	-	05:30	-	-	-	-	-
Vol.	-	50	-	-	-	71	-	-	-	-	-
P.H.F.	-	0.893	-	-	-	0.845	-	-	-	-	-
PM Peak	-	-	04:15	-	-	-	02:00	-	-	-	-
Vol.	-	-	87	-	-	-	45	-	-	-	-
P.H.F.	-	-	0.946	-	-	-	0.938	-	-	-	-
Percentage		31.5%	68.5%			56.5%	43.5%				
ADT/AADT		ADT 1,351		AADT 1,351							

Counts Unlimited, Inc.

County of San Diego
 Camino del Rey
 B/ Old River Road - West Lilac Road
 24 Hour Directional Volume Count

PO Box 1178
 Corona, CA 92878
 Phone: 951-268-6268
 email: counts@countsunlimited.com

CSD008
 Site Code: 003-18811

Start Time	08-Nov-18 Thu	Northbound		Hour Totals		Southbound		Hour Totals		Combined Totals	
		Morning	Afternoon	Morning	Afternoon	Morning	Afternoon	Morning	Afternoon	Morning	Afternoon
12:00		7	72			7	71				
12:15		6	99			3	65				
12:30		1	110			2	84				
12:45		1	93	15	374	6	201	18	421	33	795
01:00		3	89			1	122				
01:15		1	77			1	80				
01:30		2	147			0	90				
01:45		0	90	6	403	2	92	4	384	10	787
02:00		3	116			4	74				
02:15		3	113			0	78				
02:30		1	88			1	79				
02:45		4	79	11	396	0	89	5	320	16	716
03:00		3	111			3	102				
03:15		2	120			8	96				
03:30		7	125			4	109				
03:45		10	123	22	479	12	94	27	401	49	880
04:00		11	147			8	92				
04:15		8	158			18	93				
04:30		16	136			33	87				
04:45		18	120	53	561	38	112	97	384	150	945
05:00		17	131			36	85				
05:15		33	147			61	92				
05:30		26	133			87	86				
05:45		47	79	123	490	83	78	267	341	390	831
06:00		76	92			99	71				
06:15		97	67			111	55				
06:30		89	63			86	61				
06:45		99	49	361	271	78	52	374	239	735	510
07:00		127	46			112	50				
07:15		176	34			179	38				
07:30		115	27			226	53				
07:45		101	28	519	135	160	39	677	180	1196	315
08:00		137	29			79	34				
08:15		89	21			90	17				
08:30		70	36			61	49				
08:45		70	32	366	118	57	30	287	130	653	248
09:00		57	26			77	42				
09:15		52	16			72	35				
09:30		68	18			60	27				
09:45		53	15	230	75	61	22	270	126	500	201
10:00		56	13			65	22				
10:15		69	15			56	16				
10:30		71	15			54	8				
10:45		67	8	263	51	75	7	250	53	513	104
11:00		73	11			58	4				
11:15		77	8			56	4				
11:30		79	1			56	6				
11:45		68	3	297	23	81	4	251	18	548	41
Total		2266	3376	2266	3376	2527	2997	2527	2997	4793	6373
Combined Total		5642		5642		5524		5524		11166	
AM Peak	-	07:15	-	-	-	07:00	-	-	-	-	-
Vol.	-	529	-	-	-	677	-	-	-	-	-
P.H.F.	-	0.751	-	-	-	0.749	-	-	-	-	-
PM Peak	-	-	03:45	-	-	-	00:45	-	-	-	-
Vol.	-	-	564	-	-	-	493	-	-	-	-
P.H.F.	-	-	0.892	-	-	-	0.613	-	-	-	-
Percentage		40.2%	59.8%			45.7%	54.3%				
ADT/AADT		ADT 11,166		AADT 11,166							

Counts Unlimited, Inc.

County of San Diego
 Lilac Road
 B/ West Lilac Road - Old Castle Road
 24 Hour Directional Volume Count

PO Box 1178
 Corona, CA 92878
 Phone: 951-268-6268
 email: counts@countsunlimited.com

CSD009
 Site Code: 003-18811

Start Time	08-Nov-18 Thu	Eastbound		Hour Totals		Westbound		Hour Totals		Combined Totals	
		Morning	Afternoon	Morning	Afternoon	Morning	Afternoon	Morning	Afternoon	Morning	Afternoon
12:00		2	12			0	22				
12:15		0	20			4	22				
12:30		0	15			1	20				
12:45		0	23	2	70	1	14	6	78	8	148
01:00		0	42			2	19				
01:15		0	31			1	33				
01:30		0	47			1	15				
01:45		0	49	0	169	0	27	4	94	4	263
02:00		0	52			1	29				
02:15		0	62			0	24				
02:30		0	43			0	31				
02:45		0	52	0	209	1	22	2	106	2	315
03:00		0	37			1	22				
03:15		2	66			0	39				
03:30		3	64			2	26				
03:45		0	57	5	224	0	25	3	112	8	336
04:00		1	56			0	27				
04:15		4	70			2	33				
04:30		4	75			1	40				
04:45		7	75	16	276	1	29	4	129	20	405
05:00		12	61			2	36				
05:15		17	63			5	44				
05:30		16	51			5	29				
05:45		23	48	68	223	6	29	18	138	86	361
06:00		20	37			4	30				
06:15		20	35			13	18				
06:30		28	33			11	27				
06:45		44	26	112	131	15	17	43	92	155	223
07:00		33	26			8	18				
07:15		34	20			11	16				
07:30		37	19			22	16				
07:45		40	19	144	84	20	16	61	66	205	150
08:00		41	30			15	15				
08:15		28	21			23	10				
08:30		17	12			29	12				
08:45		28	21	114	84	11	11	78	48	192	132
09:00		20	15			10	17				
09:15		25	12			9	7				
09:30		17	8			10	9				
09:45		15	14	77	49	15	10	44	43	121	92
10:00		26	10			23	2				
10:15		16	9			8	5				
10:30		20	4			17	6				
10:45		24	5	86	28	17	2	65	15	151	43
11:00		25	6			20	4				
11:15		21	6			20	4				
11:30		14	8			15	2				
11:45		24	5	84	25	16	4	71	14	155	39
Total		708	1572	708	1572	399	935	399	935	1107	2507
Combined Total		2280		2280		1334		1334		3614	
AM Peak	-	07:15	-	-	-	07:45	-	-	-	-	-
Vol.	-	152	-	-	-	87	-	-	-	-	-
P.H.F.	-	0.927	-	-	-	0.750	-	-	-	-	-
PM Peak	-	-	04:15	-	-	-	04:30	-	-	-	-
Vol.	-	-	281	-	-	-	149	-	-	-	-
P.H.F.	-	-	0.937	-	-	-	0.847	-	-	-	-
Percentage		31.1%	68.9%			29.9%	70.1%				
ADT/AADT		ADT 3,614		AADT 3,614							

Counts Unlimited, Inc.

County of San Diego
 Old Highway 395
 B/ State Route 76 - Dulin Road
 24 Hour Directional Volume Count

PO Box 1178
 Corona, CA 92878
 Phone: 951-268-6268
 email: counts@countsunlimited.com

CSD010
 Site Code: 003-18811

Start Time	08-Nov-18 Thu	Northbound		Hour Totals		Southbound		Hour Totals		Combined Totals	
		Morning	Afternoon	Morning	Afternoon	Morning	Afternoon	Morning	Afternoon	Morning	Afternoon
12:00		4	69			3	29				
12:15		0	55			1	37				
12:30		4	55			3	41				
12:45		1	42	9	221	0	53	7	160	16	381
01:00		0	32			2	53				
01:15		1	29			0	50				
01:30		0	47			5	60				
01:45		2	66	3	174	2	61	9	224	12	398
02:00		1	63			1	73				
02:15		3	75			2	37				
02:30		0	68			2	65				
02:45		0	64	4	270	0	35	5	210	9	480
03:00		1	68			0	48				
03:15		2	80			4	58				
03:30		2	76			1	70				
03:45		2	82	7	306	3	69	8	245	15	551
04:00		5	74			5	48				
04:15		6	78			3	66				
04:30		11	86			8	63				
04:45		6	73	28	311	9	71	25	248	53	559
05:00		7	66			14	62				
05:15		12	63			30	56				
05:30		14	78			48	49				
05:45		37	65	70	272	62	56	154	223	224	495
06:00		31	54			102	47				
06:15		40	56			109	47				
06:30		36	33			153	34				
06:45		46	38	153	181	134	28	498	156	651	337
07:00		65	21			155	45				
07:15		64	22			157	30				
07:30		89	20			148	22				
07:45		64	16	282	79	106	22	566	119	848	198
08:00		72	13			74	28				
08:15		68	15			91	30				
08:30		47	14			57	20				
08:45		48	16	235	58	45	31	267	109	502	167
09:00		23	8			43	25				
09:15		41	13			29	16				
09:30		39	14			31	18				
09:45		43	15	146	50	31	15	134	74	280	124
10:00		33	5			42	19				
10:15		32	7			43	12				
10:30		33	11			35	10				
10:45		37	4	135	27	31	4	151	45	286	72
11:00		50	2			32	9				
11:15		42	2			56	8				
11:30		43	2			42	2				
11:45		47	2	182	8	45	4	175	23	357	31
Total		1254	1957	1254	1957	1999	1836	1999	1836	3253	3793
Combined Total		3211		3211		3835		3835		7046	
AM Peak	-	07:30	-	-	-	06:30	-	-	-	-	-
Vol.	-	293	-	-	-	599	-	-	-	-	-
P.H.F.	-	0.823	-	-	-	0.954	-	-	-	-	-
PM Peak	-	-	03:45	-	-	-	04:15	-	-	-	-
Vol.	-	-	320	-	-	-	262	-	-	-	-
P.H.F.	-	-	0.930	-	-	-	0.923	-	-	-	-
Percentage		39.1%	60.9%			52.1%	47.9%				
ADT/AADT		ADT 7,046		AADT 7,046							

Counts Unlimited, Inc.

County of San Diego
 Old Highway 395
 B/ Dulin Road North - Dulin Road South
 24 Hour Directional Volume Count

PO Box 1178
 Corona, CA 92878
 Phone: 951-268-6268
 email: counts@countsunlimited.com

CSD011
 Site Code: 003-18811

Start Time	08-Nov-18 Thu	Northbound		Hour Totals		Southbound		Hour Totals		Combined Totals	
		Morning	Afternoon	Morning	Afternoon	Morning	Afternoon	Morning	Afternoon	Morning	Afternoon
12:00		9	26			2	33				
12:15		8	38			1	25				
12:30		4	30			1	32				
12:45		1	37	22	131	1	33	5	123	27	254
01:00		0	32			2	42				
01:15		1	31			1	35				
01:30		2	33			3	48				
01:45		2	32	5	128	2	51	8	176	13	304
02:00		1	31			0	43				
02:15		3	48			2	55				
02:30		0	62			0	41				
02:45		0	82	4	223	1	42	3	181	7	404
03:00		1	60			2	58				
03:15		0	127			6	60				
03:30		0	107			2	66				
03:45		2	125	3	419	5	70	15	254	18	673
04:00		2	93			5	33				
04:15		3	99			7	36				
04:30		4	94			16	36				
04:45		6	76	15	362	19	43	47	148	62	510
05:00		2	75			23	54				
05:15		10	88			61	43				
05:30		7	83			74	22				
05:45		12	62	31	308	94	40	252	159	283	467
06:00		15	61			133	18				
06:15		20	41			157	29				
06:30		17	33			174	24				
06:45		30	37	82	172	182	13	646	84	728	256
07:00		20	41			190	14				
07:15		28	38			223	18				
07:30		45	26			175	14				
07:45		57	19	150	124	104	12	692	58	842	182
08:00		73	29			115	7				
08:15		67	22			99	8				
08:30		37	10			69	6				
08:45		38	21	215	82	53	10	336	31	551	113
09:00		22	15			41	11				
09:15		27	17			35	12				
09:30		35	9			52	6				
09:45		33	13	117	54	34	6	162	35	279	89
10:00		23	12			38	4				
10:15		26	7			40	3				
10:30		27	8			38	8				
10:45		30	7	106	34	35	3	151	18	257	52
11:00		42	7			34	3				
11:15		37	3			41	1				
11:30		31	3			36	5				
11:45		35	5	145	18	42	2	153	11	298	29
Total		895	2055	895	2055	2470	1278	2470	1278	3365	3333
Combined Total		2950		2950		3748		3748		6698	
AM Peak	-	07:30	-	-	-	06:45	-	-	-	-	-
Vol.	-	242	-	-	-	770	-	-	-	-	-
P.H.F.	-	0.829	-	-	-	0.863	-	-	-	-	-
PM Peak	-	-	03:15	-	-	-	03:00	-	-	-	-
Vol.	-	-	452	-	-	-	254	-	-	-	-
P.H.F.	-	-	0.890	-	-	-	0.907	-	-	-	-
Percentage		30.3%	69.7%			65.9%	34.1%				
ADT/AADT		ADT 6,698		AADT 6,698							

Counts Unlimited, Inc.

County of San Diego
 Old Highway 395
 B/ West Lilac Road - Via Urner Road
 24 Hour Directional Volume Count

PO Box 1178
 Corona, CA 92878
 Phone: 951-268-6268
 email: counts@countsunlimited.com

CSD012
 Site Code: 003-18811

Start Time	08-Nov-18 Thu	Northbound		Hour Totals		Southbound		Hour Totals		Combined Totals	
		Morning	Afternoon	Morning	Afternoon	Morning	Afternoon	Morning	Afternoon	Morning	Afternoon
12:00		9	36			1	31				
12:15		4	43			1	28				
12:30		2	43			1	28				
12:45		1	34	16	156	2	37	5	124	21	280
01:00		0	45			1	45				
01:15		3	41			0	39				
01:30		1	59			2	33				
01:45		2	48	6	193	0	47	3	164	9	357
02:00		2	70			1	31				
02:15		0	72			0	26				
02:30		0	77			1	33				
02:45		0	69	2	288	1	60	3	150	5	438
03:00		0	99			5	54				
03:15		1	91			3	43				
03:30		1	103			5	46				
03:45		0	83	2	376	4	45	17	188	19	564
04:00		0	83			11	33				
04:15		2	117			15	35				
04:30		3	77			21	37				
04:45		3	67	8	344	28	38	75	143	83	487
05:00		3	81			59	27				
05:15		10	89			73	25				
05:30		16	75			102	17				
05:45		12	80	41	325	150	24	384	93	425	418
06:00		21	63			161	21				
06:15		21	47			158	15				
06:30		29	52			181	14				
06:45		25	29	96	191	182	13	682	63	778	254
07:00		19	23			209	19				
07:15		30	22			151	17				
07:30		42	27			114	10				
07:45		32	12	123	84	80	6	554	52	677	136
08:00		35	27			72	9				
08:15		30	13			75	6				
08:30		23	17			66	7				
08:45		19	21	107	78	63	8	276	30	383	108
09:00		28	16			56	1				
09:15		28	21			69	5				
09:30		24	15			49	2				
09:45		19	11	99	63	46	2	220	10	319	73
10:00		26	9			45	9				
10:15		19	12			44	5				
10:30		29	3			34	2				
10:45		30	10	104	34	36	1	159	17	263	51
11:00		32	8			32	3				
11:15		22	2			36	4				
11:30		29	7			37	1				
11:45		28	3	111	20	24	0	129	8	240	28
Total		715	2152	715	2152	2507	1042	2507	1042	3222	3194
Combined Total		2867		2867		3549		3549		6416	
AM Peak	-	07:15	-	-	-	06:15	-	-	-	-	-
Vol.	-	139	-	-	-	730	-	-	-	-	-
P.H.F.	-	0.827	-	-	-	0.873	-	-	-	-	-
PM Peak	-	-	03:30	-	-	-	02:45	-	-	-	-
Vol.	-	-	386	-	-	-	203	-	-	-	-
P.H.F.	-	-	0.825	-	-	-	0.846	-	-	-	-
Percentage		24.9%	75.1%			70.6%	29.4%				
ADT/AADT		ADT 6,416		AADT 6,416							

Counts Unlimited, Inc.

County of San Diego
Old Highway 395

PO Box 1178
Corona, CA 92878

B/ Interstate 15 Southbound - Interstate 15 Northbound
24 Hour Directional Volume Count

Phone: 951-268-6268
email: counts@countsunlimited.com

CSD013
Site Code: 003-18811

Start Time	08-Nov-18 Thu	Northbound		Hour Totals		Southbound		Hour Totals		Combined Totals	
		Morning	Afternoon	Morning	Afternoon	Morning	Afternoon	Morning	Afternoon	Morning	Afternoon
12:00		12	30			0	30				
12:15		4	38			2	21				
12:30		2	40			0	21				
12:45		1	34	19	142	3	30	5	102	24	244
01:00		0	34			1	24				
01:15		3	32			1	29				
01:30		0	45			2	30				
01:45		1	52	4	163	0	43	4	126	8	289
02:00		2	41			2	26				
02:15		0	56			0	28				
02:30		0	89			1	28				
02:45		0	65	2	251	0	25	3	107	5	358
03:00		0	95			0	27				
03:15		1	97			0	30				
03:30		2	95			0	31				
03:45		0	73	3	360	1	23	1	111	4	471
04:00		1	98			4	28				
04:15		3	76			7	38				
04:30		4	76			7	39				
04:45		7	88	15	338	7	25	25	130	40	468
05:00		4	83			19	24				
05:15		20	89			19	27				
05:30		38	63			47	11				
05:45		22	58	84	293	62	13	147	75	231	368
06:00		36	52			83	18				
06:15		23	37			112	18				
06:30		28	39			137	6				
06:45		28	52	115	180	166	11	498	53	613	233
07:00		18	44			129	11				
07:15		30	28			81	6				
07:30		43	28			125	7				
07:45		32	31	123	131	45	5	380	29	503	160
08:00		28	29			51	13				
08:15		32	18			48	3				
08:30		24	22			27	13				
08:45		20	26	104	95	31	10	157	39	261	134
09:00		30	20			26	2				
09:15		27	11			30	4				
09:30		24	17			29	7				
09:45		21	13	102	61	23	10	108	23	210	84
10:00		28	11			29	3				
10:15		25	7			23	7				
10:30		26	11			25	3				
10:45		31	6	110	35	30	5	107	18	217	53
11:00		30	3			31	3				
11:15		33	3			16	3				
11:30		28	8			18	0				
11:45		29	10	120	24	20	3	85	9	205	33
Total		801	2073	801	2073	1520	822	1520	822	2321	2895
Combined Total		2874		2874		2342		2342		5216	
AM Peak	-	07:30	-	-	-	06:15	-	-	-	-	-
Vol.	-	135	-	-	-	544	-	-	-	-	-
P.H.F.		0.785				0.819					
PM Peak	-	-	03:15	-	-	-	04:00	-	-	-	-
Vol.	-	-	363	-	-	-	130	-	-	-	-
P.H.F.			0.926				0.756				
Percentage		27.9%	72.1%			64.9%	35.1%				
ADT/AADT		ADT 5,216		AADT 5,216							

Counts Unlimited, Inc.

County of San Diego
 Old Highway 395
 B/ Camino del Rey - Nelson Way
 24 Hour Directional Volume Count

PO Box 1178
 Corona, CA 92878
 Phone: 951-268-6268
 email: counts@countsunlimited.com

CSD014
 Site Code: 003-18811

Start Time	08-Nov-18 Thu	Northbound		Hour Totals		Southbound		Hour Totals		Combined Totals	
		Morning	Afternoon	Morning	Afternoon	Morning	Afternoon	Morning	Afternoon	Morning	Afternoon
12:00		4	32			0	23				
12:15		2	23			2	28				
12:30		2	28			1	28				
12:45		0	40	8	123	1	24	4	103	12	226
01:00		0	36			0	29				
01:15		0	48			1	26				
01:30		1	45			1	34				
01:45		0	45	1	174	3	34	5	123	6	297
02:00		0	47			0	40				
02:15		2	50			1	37				
02:30		3	49			1	34				
02:45		0	64	5	210	0	27	2	138	7	348
03:00		0	67			3	31				
03:15		1	66			0	30				
03:30		0	88			0	36				
03:45		1	80	2	301	2	35	5	132	7	433
04:00		1	66			1	26				
04:15		0	65			6	33				
04:30		3	62			7	44				
04:45		2	56	6	249	11	32	25	135	31	384
05:00		4	50			11	36				
05:15		4	59			21	20				
05:30		10	59			36	31				
05:45		14	52	32	220	56	22	124	109	156	329
06:00		18	45			75	14				
06:15		21	40			90	26				
06:30		32	29			123	20				
06:45		17	17	88	131	152	11	440	71	528	202
07:00		18	20			168	15				
07:15		22	19			161	11				
07:30		23	17			106	5				
07:45		26	16	89	72	129	9	564	40	653	112
08:00		28	14			66	2				
08:15		28	16			52	7				
08:30		21	11			39	7				
08:45		28	22	105	63	34	16	191	32	296	95
09:00		24	10			27	4				
09:15		24	8			30	5				
09:30		29	13			35	4				
09:45		26	10	103	41	36	7	128	20	231	61
10:00		21	4			22	10				
10:15		28	8			42	3				
10:30		26	10			23	6				
10:45		33	5	108	27	21	3	108	22	216	49
11:00		27	3			31	4				
11:15		33	4			30	4				
11:30		35	3			26	2				
11:45		55	4	150	14	26	1	113	11	263	25
Total		697	1625	697	1625	1709	936	1709	936	2406	2561
Combined Total		2322		2322		2645		2645		4967	
AM Peak	-	11:00	-	-	-	06:30	-	-	-	-	-
Vol.	-	150	-	-	-	604	-	-	-	-	-
P.H.F.	-	0.682	-	-	-	0.899	-	-	-	-	-
PM Peak	-	-	03:00	-	-	-	01:30	-	-	-	-
Vol.	-	-	301	-	-	-	145	-	-	-	-
P.H.F.	-	-	0.855	-	-	-	0.906	-	-	-	-
Percentage		30.0%	70.0%			64.6%	35.4%				
ADT/AADT		ADT 4,967		AADT 4,967							

Counts Unlimited, Inc.

County of San Diego
 Old Highway 395
 B/ Circle R Drive - Camino Del Rey
 24 Hour Directional Volume Count

PO Box 1178
 Corona, CA 92878
 Phone: 951-268-6268
 email: counts@countsunlimited.com

CSD015
 Site Code: 003-18811

Start Time	08-Nov-18 Thu	Northbound		Hour Totals		Southbound		Hour Totals		Combined Totals	
		Morning	Afternoon	Morning	Afternoon	Morning	Afternoon	Morning	Afternoon	Morning	Afternoon
12:00		9	108			2	50				
12:15		4	133			2	44				
12:30		6	112			2	48				
12:45		1	124	20	477	3	52	9	194	29	671
01:00		1	116			2	68				
01:15		2	142			2	46				
01:30		3	136			1	58				
01:45		3	132	9	526	2	62	7	234	16	760
02:00		1	152			0	52				
02:15		2	136			1	44				
02:30		4	157			3	56				
02:45		1	174	8	619	1	75	5	227	13	846
03:00		2	162			4	60				
03:15		3	191			0	70				
03:30		3	246			2	70				
03:45		4	232	12	831	5	74	11	274	23	1105
04:00		1	217			11	82				
04:15		2	242			9	80				
04:30		6	239			13	73				
04:45		7	214	16	912	24	63	57	298	73	1210
05:00		10	194			38	66				
05:15		16	200			43	64				
05:30		17	196			64	66				
05:45		22	174	65	764	104	53	249	249	314	1013
06:00		29	144			134	45				
06:15		58	134			170	28				
06:30		68	115			194	35				
06:45		68	94	223	487	240	28	738	136	961	623
07:00		50	70			222	27				
07:15		101	76			228	26				
07:30		66	54			198	16				
07:45		54	51	271	251	172	14	820	83	1091	334
08:00		58	60			160	26				
08:15		58	50			116	10				
08:30		52	45			93	14				
08:45		50	59	218	214	88	10	457	60	675	274
09:00		44	56			64	10				
09:15		36	36			64	14				
09:30		44	37			76	16				
09:45		52	41	176	170	79	8	283	48	459	218
10:00		40	23			70	8				
10:15		47	30			57	6				
10:30		42	29			72	4				
10:45		50	26	179	108	56	10	255	28	434	136
11:00		54	19			58	3				
11:15		84	15			52	5				
11:30		106	13			60	1				
11:45		120	10	364	57	66	4	236	13	600	70
Total		1561	5416	1561	5416	3127	1844	3127	1844	4688	7260
Combined Total		6977		6977		4971		4971		11948	
AM Peak	-	11:00	-	-	-	06:45	-	-	-	-	-
Vol.	-	364	-	-	-	888	-	-	-	-	-
P.H.F.	-	0.758	-	-	-	0.925	-	-	-	-	-
PM Peak	-	-	03:30	-	-	-	03:45	-	-	-	-
Vol.	-	-	937	-	-	-	309	-	-	-	-
P.H.F.	-	-	0.952	-	-	-	0.942	-	-	-	-
Percentage		22.4%	77.6%			62.9%	37.1%				
ADT/AADT		ADT 11,948		AADT 11,948							

Counts Unlimited, Inc.

County of San Diego
 Old River Road
 B/ Golf Club Drive - Dentro de Lomas Drive
 24 Hour Directional Volume Count

PO Box 1178
 Corona, CA 92878
 Phone: 951-268-6268
 email: counts@countsunlimited.com

CSD017
 Site Code: 003-18811

Start Time	08-Nov-18 Thu	Eastbound		Hour Totals		Westbound		Hour Totals		Combined Totals	
		Morning	Afternoon	Morning	Afternoon	Morning	Afternoon	Morning	Afternoon	Morning	Afternoon
12:00		0	22			0	18				
12:15		2	29			0	11				
12:30		0	23			0	15				
12:45		0	24	2	98	0	14	0	58	2	156
01:00		1	16			0	34				
01:15		0	19			0	18				
01:30		0	19			0	27				
01:45		0	19	1	73	0	20	0	99	1	172
02:00		0	23			0	27				
02:15		1	20			0	16				
02:30		0	19			0	21				
02:45		0	17	1	79	0	21	0	85	1	164
03:00		0	21			0	19				
03:15		0	32			0	29				
03:30		0	20			1	20				
03:45		0	16	0	89	3	17	4	85	4	174
04:00		0	19			4	26				
04:15		2	19			2	18				
04:30		0	15			0	15				
04:45		0	21	2	74	3	15	9	74	11	148
05:00		1	29			3	21				
05:15		3	21			5	18				
05:30		2	24			9	7				
05:45		4	21	10	95	12	10	29	56	39	151
06:00		3	18			13	12				
06:15		4	11			30	15				
06:30		6	11			60	5				
06:45		15	11	28	51	62	8	165	40	193	91
07:00		11	9			77	9				
07:15		18	6			78	5				
07:30		33	7			64	2				
07:45		26	6	88	28	74	8	293	24	381	52
08:00		15	3			49	5				
08:15		9	3			38	3				
08:30		10	4			28	8				
08:45		9	8	43	18	18	3	133	19	176	37
09:00		10	4			23	4				
09:15		14	5			26	4				
09:30		12	7			15	3				
09:45		14	8	50	24	22	4	86	15	136	39
10:00		9	2			16	3				
10:15		11	1			13	5				
10:30		15	0			19	0				
10:45		18	3	53	6	18	0	66	8	119	14
11:00		27	3			14	0				
11:15		15	3			23	1				
11:30		8	1			16	2				
11:45		10	0	60	7	25	0	78	3	138	10
Total		338	642	338	642	863	566	863	566	1201	1208
Combined Total		980		980		1429		1429		2409	
AM Peak	-	07:15	-	-	-	07:00	-	-	-	-	-
Vol.	-	92	-	-	-	293	-	-	-	-	-
P.H.F.	-	0.697	-	-	-	0.939	-	-	-	-	-
PM Peak	-	-	12:00	-	-	-	01:00	-	-	-	-
Vol.	-	-	98	-	-	-	99	-	-	-	-
P.H.F.	-	-	0.845	-	-	-	0.728	-	-	-	-
Percentage		34.5%	65.5%			60.4%	39.6%				
ADT/AADT		ADT 2,409		AADT 2,409							

Counts Unlimited, Inc.

County of San Diego
 Camino del Rey
 W/ Maria Elena
 24 Hour Directional Volume Count

PO Box 1178
 Corona, CA 92878
 Phone: 951-268-6268
 email: counts@countsunlimited.com

CSD018
 Site Code: 003-18811

Start Time	08-Nov-18 Thu	Eastbound		Hour Totals		Westbound		Hour Totals		Combined Totals	
		Morning	Afternoon	Morning	Afternoon	Morning	Afternoon	Morning	Afternoon	Morning	Afternoon
12:00		1	53			3	39				
12:15		2	40			4	50				
12:30		1	40			4	64				
12:45		1	37	5	170	1	62	12	215	17	385
01:00		1	71			1	34				
01:15		0	52			2	45				
01:30		0	46			1	49				
01:45		0	46	1	215	3	50	7	178	8	393
02:00		0	50			1	52				
02:15		2	51			1	48				
02:30		0	44			1	60				
02:45		0	44	2	189	1	60	4	220	6	409
03:00		1	44			2	60				
03:15		2	62			1	85				
03:30		4	56			4	90				
03:45		6	63	13	225	2	96	9	331	22	556
04:00		8	59			1	96				
04:15		4	52			5	102				
04:30		16	37			2	112				
04:45		30	40	58	188	9	110	17	420	75	608
05:00		28	44			9	84				
05:15		32	47			10	108				
05:30		40	40			11	84				
05:45		81	39	181	170	14	79	44	355	225	525
06:00		80	35			20	64				
06:15		90	32			42	60				
06:30		114	28			42	40				
06:45		80	19	364	114	48	51	152	215	516	329
07:00		62	13			42	40				
07:15		73	18			49	28				
07:30		110	8			64	25				
07:45		80	26	325	65	46	26	201	119	526	184
08:00		81	14			32	26				
08:15		58	10			39	28				
08:30		72	11			48	19				
08:45		49	9	260	44	31	25	150	98	410	142
09:00		42	10			35	24				
09:15		57	16			35	22				
09:30		60	12			34	16				
09:45		49	8	208	46	35	14	139	76	347	122
10:00		38	8			34	8				
10:15		40	6			37	11				
10:30		43	8			35	13				
10:45		38	2	159	24	30	10	136	42	295	66
11:00		48	2			34	7				
11:15		36	2			40	11				
11:30		32	2			46	8				
11:45		41	3	157	9	38	1	158	27	315	36
Total		1733	1459	1733	1459	1029	2296	1029	2296	2762	3755
Combined Total		3192		3192		3325		3325		6517	
AM Peak	-	05:45	-	-	-	06:45	-	-	-	-	-
Vol.	-	365	-	-	-	203	-	-	-	-	-
P.H.F.	-	0.800	-	-	-	0.793	-	-	-	-	-
PM Peak	-	-	03:15	-	-	-	04:00	-	-	-	-
Vol.	-	-	240	-	-	-	420	-	-	-	-
P.H.F.	-	-	0.952	-	-	-	0.938	-	-	-	-
Percentage		54.3%	45.7%			30.9%	69.1%				
ADT/AADT		ADT 6,517		AADT 6,517							



2017 Traffic Volumes (for ALL vehicles on CA State Highways)

2017 Volumes Home

[Return to Census Program](#) or [Jump to 2011](#) | [2012](#) | [2013](#) | [2014](#) | [2015](#) | [2016](#) | [2017](#)

Dist	Rte	CO	Post Mile	Description	Back Peak Hour	Back Peak Month	Back AADT	Ahead Peak Hour	Ahead Peak Month	Ahead AADT
11	015	SD	M 18.176	SAN DIEGO, POWAY ROAD	20200	266000	254000	18300	237000	222000
11	015	SD	M 19.468	JCT. RTE. 56	18300	237000	222000	17900	247000	238000
11	015	SD	M 20.574	CARMEL MOUNTAIN ROAD	17900	247000	238000	16800	236000	227000
11	015	SD	M 21.915	SAN DIEGO, CAMINO DEL NORTE	16800	236000	227000	16700	236000	221000
11	015	SD	M 22.935	SAN DIEGO, BERNARDO CENTER DRIVE	16700	236000	221000	16200	228000	212000
11	015	SD	M 23.687	SAN DIEGO, RANCHO BERNARDO ROAD	16200	228000	212000	16000	223000	216000
11	015	SD	M 26.026	POMERADO ROAD	16000	223000	216000	17200	232000	226000
11	015	SD	M 26.970	ESCONDIDO, FELICITA ROAD	17200	232000	226000	17300	227000	217000
11	015	SD	M 27.650	ESCONDIDO, SOUTH JCT. OF CENTRE CITY PKWY	17300	227000	217000	18200	229000	210000
11	015	SD	R 28.765	CITRACADO PARKWAY	18200	229000	210000	21100	279000	264000
11	015	SD	R 30.090	ESCONDIDO, 9TH AVENUE	21100	279000	264000	18000	231000	211000
11	015	SD	R 30.627	VALLEY PARKWAY	18000	231000	211000	22900	293000	291000
11	015	SD	R 31.517	JCT. RTE. 78	22900	293000	291000	12100	159000	152000
11	015	SD	R 32.861	ESCONDIDO, EL NORTE PARKWAY	12100	159000	152000	10300	139000	134000
11	015	SD	R 33.922	CENTRE CITY PARKWAY	10300	139000	134000	10900	146000	141000
11	015	SD	R 36.636	DEER SPRINGS ROAD	10900	146000	141000	11800	150000	146000
11	015	SD	R 40.842	GOPHER CANYON ROAD	11800	150000	146000	10800	148000	138000
11	015	SD	R 43.279	ESCONDIDO HIGHWAY	10800	148000	138000	10900	142000	137000
11	015	SD	R 46.491	JCT. RTE. 76	10500	142000	137000	13400	180000	146000
11	015	SD	R 50.585	MISSION ROAD	13400	180000	146000	11500	153000	148000
11	015	SD	R 54.070	RAINBOW VALLEY BOULEVARD	11500	153000	148000	11500	152000	147000
11	015	SD	R 54.258	SAN DIEGO/RIVERSIDE COUNTY LINE	11500	152000	147000			



2017 Traffic Volumes (for ALL vehicles on CA State Highways)

2017 Volumes Home ▾

[Return to Census Program](#) or [Jump to 2011](#) | [2012](#) | [2013](#) | [2014](#) | [2015](#) | [2016](#) | [2017](#)

Dist	Rte	CO	Post Mile	Description	Back Peak Hour	Back Peak Month	Back AADT	Ahead Peak Hour	Ahead Peak Month	Ahead AADT
11	075	SD	R 22.261	JCT. RTE. 5	7100	86000	79000			
11	076	SD	R 0.000	JCT. RTE. 5				3700	55000	51000
11	076	SD	R 0.486	OCEANSIDE, LORETTA STREET	3700	55000	51000	3950	53000	45000
11	076	SD	R 1.156	OCEANSIDE, CANYON DRIVE	3700	49500	42000	4050	51000	46500
11	076	SD	R 1.767	OCEANSIDE, BENET ROAD	3750	47500	43000	3850	48500	43000
11	076	SD	R 2.145	OCEANSIDE, AIRPORT ROAD	3850	48500	43000	4050	52000	47500
11	076	SD	R 3.389	OCEANSIDE, EL CAMINO REAL	4050	52000	47500	3650	44000	41500
11	076	SD	R 3.745	OCEANSIDE, DOUGLAS STREET	3650	44000	41500	3850	47500	46500
11	076	SD	R 4.211	OCEANSIDE, RANCHO DEL ORO	3250	40500	36500	3150	39500	36500
11	076	SD	R 5.597	OCEANSIDE, FRAZEE ROAD	3150	39500	36500	3800	47000	43500
11	076	SD	R 6.207	COLLEGE BOULEVARD	3600	44500	41000	4800	47500	46000
11	076	SD	R 6.721	OCEANSIDE, NORTH SANTA FE ROAD	4800	47500	46000	4550	51000	50000
11	076	SD	R 9.490	VISTA WAY	3300	43000	40000	3250	39500	37000
11	076	SD	12.000	OLIVE HILL ROAD	3800	49500	45500	3450	41500	39000
11	076	SD	12.180	THOROUGHbred LN - RT	3800	46000	43000	3450	41500	39000
11	076	SD	12.472	MISSION ROAD	3450	41500	39000	1600	18700	17600
11	076	SD	14.700	GIRD ROAD	1600	18700	17600	2100	24400	23500
11	076	SD	R 17.012	OLD HIGHWAY 15	2100	24400	23500	2600	33500	30500
11	076	SD	R 17.303	JCT. RTE. 15	2500	34000	30500	2150	16000	15100
11	076	SD	23.010	PALA MISSION ROAD	1400	13500	12600	610	7200	6900
11	076	SD	24.130	COUNTY ROAD S 16	690	8200	7800	960	11600	11000
11	076	SD	29.866	COLE GRADE ROAD	1000	12000	11400	860	9300	9100

2016

**Annual Average Daily Truck Traffic
on the
California State Highway System**

Compiled by
Traffic Data Branch

State of California
California State Transportation Agency
Department of Transportation

Prepared in cooperation with the
U.S. Department of Transportation
Federal Highway Administration

PREFACE

The annual average daily truck traffic is shown for selected locations on the State Highway System. Truck traffic is classified by number of axles. The two-axle class includes 11/2-ton trucks with dual rear tires and excludes pickups and vans with only four tires. Total vehicle AADT for the same year is taken from the Traffic Volumes on California State Highways booklet also published by the California Department of Transportation.

Annual average daily truck traffic is the total truck traffic volume divided by 365 days. Truck counting is done throughout the state in a program of continuous truck count sampling. The sampling includes a partial day, 24-hour, 7-day and continuous vehicle classification counts. The partial day and 24-hour counts are usually made on high volume, urban highways. The 7-day counts are made on low volume, rural highways. The counts are usually taken only once in the year. About one-sixth of the locations are counted annually. The resulting counts are adjusted to an estimate of annual average daily truck traffic by compensating for seasonal influence, weekly variation, and other variables that may be present. Annual average daily truck traffic is necessary for presenting a statewide picture of truck flow, evaluating truck trends, planning and designing highways and for other purposes.

The column entitled "Year Ver/Est" indicates the year the truck percent were either verified (V) or estimated (E). It represents the year the truck percentages were verified (counted continuously or quarterly) or estimated. Selected points on a route will be counted and the ones in between will be estimated. At some locations, truck volumes are static and no new counts are made until there is a change in traffic on the route. All truck AADT's listed are for 2016.

California State Highways are listed in legislative route number order. The legislative route number is the same as the signed route number in most cases.

Each count location is identified by the post mile value corresponding to that point on the highway. The post mile values increase from the beginning of a route within a county to the next county line. The post mile values start over again at each county line. Post mile values increase usually from south to north or west to east depending on the general direction the route follows within the state.

The post mile at a given location will remain the same year after year except in a few cases when the route was relocated/re-designated. When a section of road is relocated, new post miles (usually noted by an alphabetical prefix such as "R" or "M") are established for it. If relocation results in a change in length, "post mile equations" are introduced so that post miles on the remainder of the route within the county will remain unchanged. Post mile equations are not shown on this listing.

A leg is given for each count location and is denoted by an A, B or O. For traffic volumes purposes, a highway intersection or interchange has two legs. According to ascending post miles (route direction) and a post mile reference at the center of the intersection or interchange, B = back leg, A = ahead leg, and O = traffic volume is equal for the back and ahead legs.

Truck AADT's are shown as two-way traffic. Equivalent axle loading (EAL) are calculated to represent two-way travel.

Data compiled by:

Division of Traffic Operations, Office of Performance
Traffic Data Branch
(916) 654-4707

Price: \$15.00

2016 Daily Truck Traffic

RTE	DIST	CNTY	POST MILE	L E G	DESCRIPTION	VEHICLE	TRUCK	TRUCK	TRUCK			AADT	TOTAL	%	TRUCK	AADT	EAL		YEAR
						AADT	AADT	% TOT	By Axle			By Axle	By Axle	2-WAY		VER/			
						TOTAL	TOTAL	VEH	2	3	4	5+	2	3	4	5+	(1000)	EST	
15	11	SD	M14.285	A	SAN DIEGO, MIRAMAR/ POMERADO RDS	285000	11114	3.90	6513	1167	433	3001	58.60	11	4	27	1434	85V	
15	11	SD	M18.176	B	SAN DIEGO, POWAY RD	248000	17609	7.10	8593	1990	986	6040	48.80	11	6	34	2713	96E	
15	11	SD	M18.176	A	SAN DIEGO, POWAY RD	216000	15336	7.10	7484	1733	859	5260	48.80	11	6	34	2362	96E	
15	11	SD	M27.65	A	ESCONDIDO, SOUTH JUNCTION OF CENTRE CITY PARKWAY	230000	16329	7.10	7969	1845	914	5601	48.80	11	6	34	2515	96E	
15	11	SD	R30.627	B	VALLEY PARKWAY	226000	16046	7.10	7830	1813	899	5504	48.80	11	6	34	2472	96E	
15	11	SD	R31.517	X	JCT. RTE. 78	122000	7676	6.29	4440	534	278	2424	57.84	7	4	32	1082	16E	
15	11	SD	R31.517	B	JCT. RTE. 78	243000	17253	7.10	8419	1950	966	5918	48.80	11	6	34	2658	96E	
15	11	SD	R31.517	A	JCT. RTE. 78	150000	15150	10.10	6696	1303	788	6363	44.20	9	5	42	2665	80V	
15	11	SD	R36.636	A	DEER SPRINGS RD	129000	17028	13.20	6011	1379	715	8923	35.30	8	4	52	3521	86V	
15	11	SD	R46.491	B	JCT. RTE. 76	132000	13504	10.23	4297	1074	460	7673	31.82	8	3	57	2964	00E	
15	11	SD	R46.491	A	JCT. RTE. 76	139000	11998	8.63	5758	1159	858	4223	47.99	10	7	35	1891	16V	
15	08	RIV	R0	A	SAN DIEGO/RIVERSIDE COUNTY LINE	145000	9789	6.75	3655	697	297	5140	37.34	7	3	53	2009	04V	
15	08	RIV	3.436	B	SOUTH JCT. RTE. 79	145000	9789	6.75	3655	697	297	5140	37.34	7	3	53	2009	04E	
15	08	RIV	3.436	A	SOUTH JCT. RTE. 79	164000	11561	7.05	4317	823	350	6071	37.34	7	3	53	2373	04E	
15	08	RIV	6.623	B	NORTH JCT RTE. 79	174000	11432	6.57	4269	814	346	6003	37.34	7	3	53	2346	04E	
15	08	RIV	8.737	B	JCT. RTE. 215 NORTH	198000	10988	5.55	4103	782	333	5770	37.34	7	3	53	2255	04E	
15	08	RIV	8.737	A	JCT. RTE. 215 NORTH	114000	10260	9.00	4624	824	418	4394	45.07	8	4	43	1815	06E	

2016 Daily Truck Traffic

























RTE	DIST	CNTY	POST MILE	L E G	DESCRIPTION	VEHICLE AADT TOTAL	TRUCK AADT TOTAL	TRUCK % TOT VEH	TRUCK				AADT TOTAL	%	TRUCK			AADT TOTAL	EAL 2-WAY (1000)	YEAR VER/ EST
									2	3	4	5+			2	3	4			
74	08	RIV	59.25	A	JCT. RTE. 243 NORTH	3300	231	7.00	180	16	7	28	78.00	7	3	12	18	90E		
74	08	RIV	71.745	B	JCT. RTE. 371 WEST	2600	182	7.00	146	13	5	18	80.00	7	3	10	13	90E		
74	08	RIV	71.745	A	JCT. RTE. 371 WEST	3400	238	7.00	195	17	7	19	82.00	7	3	8	16	90E		
74	08	RIV	R92.34	B	PALM DESERT, JCT. RTE. 111	19000	1368	7.20	1141	119	40	68	83.40	9	3	5	80	91V		
75	11	SD	9	A	SAN DIEGO, JCT. RTE. 5	68000	2040	3.00	1571	249	47	173	77.00	12	2	9	144	85V		
75	11	SD	18.47	B	CORONADO, POMONA AVE	24200	460	1.90	330	49	13	68	71.80	11	3	15	41	86E		
75	11	SD	19.586	B	JCT. RTE. 282 AT 4TH ST ON ORANGE AVE	27500	660	2.40	530	80	20	30	80.30	12	3	5	39	84V		
75	11	SD	19.586	A	JCT. RTE. 282 AT 4TH ST ON ORANGE AVE	22700	773	3.40	499	133	36	105	64.60	17	5	14	71	86E		
75	11	SD	R22.261	B	JCT. RTE. 5	80000	2240	2.80	1447	385	103	305	64.60	17	5	14	206	86V		
76	11	SD	R0	A	JCT. RTE. 5	50000	2200	4.40	1584	257	75	284	72.00	12	3	13	188	85V		
76	11	SD	R1.156	A	OCEANSIDE, CANYON DR	46500	2511	5.40	1825	206	43	437	72.70	8	2	17	240	86V		
76	11	SD	R3.389	B	OCEANSIDE, EL CAMINO REAL	51000	2549	5.00	1652	237	56	604	64.80	9	2	24	296	86V		
76	11	SD	R9.49	B	VISTA WAY	37500	1845	4.92	1405	78	44	318	76.15	4	2	17	173	16V		
76	11	SD	R9.49	A	VISTA WAY	37000	2738	7.40	1626	192	68	852	59.40	7	3	31	379	96E		
76	11	SD	12	B	OLIVE HILL RD	42500	2155	5.07	1624	108	55	368	75.36	5	3	17	202	16V		
76	11	SD	R17.303	B	JCT. RTE. 15	29500	3688	12.50	1899	288	48	1453	51.50	8	1	39	601	96E		
76	11	SD	R17.303	A	JCT. RTE. 15	14100	1973	14.00	1532	120	49	272	77.60	6	3	14	166	87E		

APPENDIX B

HCM INTERSECTION LOS WORKSHEETS

HCM 2010 Signalized Intersection Summary
 1: Highway 76 & Olive Hill Road/Camino Del Rey

Existing AM Peak Hour
 07/10/2019

												
Movement	EBL	EBT	EBR	WBL	WBT	WBR	NBL	NBT	NBR	SBL	SBT	SBR
Lane Configurations												
Traffic Volume (veh/h)	96	181	148	108	68	210	88	990	160	543	2015	46
Future Volume (veh/h)	96	181	148	108	68	210	88	990	160	543	2015	46
Number	7	4	14	3	8	18	5	2	12	1	6	16
Initial Q (Qb), veh	0	0	0	0	0	0	0	0	0	0	0	0
Ped-Bike Adj(A_pbT)	1.00		1.00	1.00		1.00	1.00		1.00	1.00		1.00
Parking Bus, Adj	1.00	1.00	1.00	1.00	1.00	1.00	1.00	1.00	1.00	1.00	1.00	1.00
Adj Sat Flow, veh/h/ln	1863	1863	1863	1863	1863	1863	1863	1863	1863	1863	1863	1863
Adj Flow Rate, veh/h	104	197	161	117	74	228	96	1076	174	590	2190	50
Adj No. of Lanes	2	1	1	1	1	1	1	3	1	2	3	1
Peak Hour Factor	0.92	0.92	0.92	0.92	0.92	0.92	0.92	0.92	0.92	0.92	0.92	0.92
Percent Heavy Veh, %	2	2	2	2	2	2	2	2	2	2	2	2
Cap, veh/h	427	231	196	286	300	255	166	1953	608	655	2447	762
Arrive On Green	0.12	0.12	0.12	0.16	0.16	0.16	0.09	0.38	0.38	0.19	0.48	0.48
Sat Flow, veh/h	3442	1863	1583	1774	1863	1583	1774	5085	1583	3442	5085	1583
Grp Volume(v), veh/h	104	197	161	117	74	228	96	1076	174	590	2190	50
Grp Sat Flow(s),veh/h/ln	1721	1863	1583	1774	1863	1583	1774	1695	1583	1721	1695	1583
Q Serve(g_s), s	4.9	18.7	17.9	10.7	6.3	25.5	9.4	29.9	13.7	30.3	70.9	3.1
Cycle Q Clear(g_c), s	4.9	18.7	17.9	10.7	6.3	25.5	9.4	29.9	13.7	30.3	70.9	3.1
Prop In Lane	1.00		1.00	1.00		1.00	1.00		1.00	1.00		1.00
Lane Grp Cap(c), veh/h	427	231	196	286	300	255	166	1953	608	655	2447	762
V/C Ratio(X)	0.24	0.85	0.82	0.41	0.25	0.89	0.58	0.55	0.29	0.90	0.90	0.07
Avail Cap(c_a), veh/h	647	350	298	520	546	464	294	2532	788	990	2532	788
HCM Platoon Ratio	1.00	1.00	1.00	1.00	1.00	1.00	1.00	1.00	1.00	1.00	1.00	1.00
Upstream Filter(I)	1.00	1.00	1.00	1.00	1.00	1.00	1.00	1.00	1.00	1.00	1.00	1.00
Uniform Delay (d), s/veh	71.5	77.5	77.2	68.1	66.3	74.3	78.5	43.5	38.5	71.5	42.7	25.1
Incr Delay (d2), s/veh	0.3	11.9	10.3	0.9	0.4	10.6	3.2	0.2	0.3	7.7	4.5	0.0
Initial Q Delay(d3),s/veh	0.0	0.0	0.0	0.0	0.0	0.0	0.0	0.0	0.0	0.0	0.0	0.0
%ile BackOfQ(50%),veh/ln	2.4	10.5	8.4	5.3	3.3	12.0	4.8	14.1	6.1	15.1	34.1	1.3
LnGrp Delay(d),s/veh	71.8	89.5	87.5	69.1	66.7	84.9	81.7	43.7	38.8	79.2	47.2	25.2
LnGrp LOS	E	F	F	E	E	F	F	D	D	E	D	C
Approach Vol, veh/h		462			419			1346			2830	
Approach Delay, s/veh		84.8			77.3			45.8			53.5	
Approach LOS		F			E			D			D	
Timer	1	2	3	4	5	6	7	8				
Assigned Phs	1	2		4	5	6		8				
Phs Duration (G+Y+Rc), s	40.1	76.9		28.5	22.6	94.5		35.2				
Change Period (Y+Rc), s	* 5.7	7.5		6.1	* 5.7	7.5		6.1				
Max Green Setting (Gmax), s	* 52	90.0		34.0	* 30	90.0		53.0				
Max Q Clear Time (g_c+I1), s	32.3	31.9		20.7	11.4	72.9		27.5				
Green Ext Time (p_c), s	2.1	11.3		1.7	0.2	14.0		1.6				
Intersection Summary												
HCM 2010 Ctrl Delay			56.3									
HCM 2010 LOS			E									
Notes												

Intersection						
Int Delay, s/veh	0					
Movement	EBL	EBR	NBL	NBT	SBT	SBR
Lane Configurations	TT		T	T	T	T
Traffic Vol, veh/h	611	214	159	63	86	286
Future Vol, veh/h	611	214	159	63	86	286
Conflicting Peds, #/hr	0	0	0	0	0	0
Sign Control	Free	Free	Stop	Stop	Free	Free
RT Channelized	-	Free	-	None	-	Free
Storage Length	0	-	150	-	-	150
Veh in Median Storage, #	-	-	-	0	0	-
Grade, %	0	-	-	0	0	-
Peak Hour Factor	82	82	82	82	82	82
Heavy Vehicles, %	2	2	2	2	2	2
Mvmt Flow	745	261	194	77	105	349

Major/Minor	Minor2	Major2		
Conflicting Flow All	105	105	-	0
Stage 1	105	105	-	-
Stage 2	0	0	-	-
Critical Hdwy	6.42	6.52	-	-
Critical Hdwy Stg 1	5.42	5.52	-	-
Critical Hdwy Stg 2	-	-	-	-
Follow-up Hdwy	3.518	4.018	-	-
Pot Cap-1 Maneuver	893	785	-	0
Stage 1	919	808	-	0
Stage 2	-	-	-	0
Platoon blocked, %			-	
Mov Cap-1 Maneuver	893	0	-	-
Mov Cap-2 Maneuver	893	0	-	-
Stage 1	919	0	-	-
Stage 2	-	0	-	-

Approach	NB	SB
HCM Control Delay, s		0
HCM LOS	-	

Minor Lane/Major Mvmt	NBLn1	NBLn2	SBT
Capacity (veh/h)	893	-	-
HCM Lane V/C Ratio	0.217	-	-
HCM Control Delay (s)	10.1	-	-
HCM Lane LOS	B	-	-
HCM 95th %tile Q(veh)	0.8	-	-

Intersection						
Int Delay, s/veh	4.4					
Movement	EBL	EBT	WBT	WBR	SBL	SBR
Lane Configurations		↶	↷		↶	↷
Traffic Vol, veh/h	300	374	317	18	8	166
Future Vol, veh/h	300	374	317	18	8	166
Conflicting Peds, #/hr	0	0	0	0	0	0
Sign Control	Free	Free	Free	Free	Stop	Stop
RT Channelized	-	None	-	None	-	Stop
Storage Length	-	-	-	-	0	100
Veh in Median Storage, #	-	0	0	-	0	-
Grade, %	-	0	0	-	0	-
Peak Hour Factor	90	90	90	90	90	90
Heavy Vehicles, %	2	2	2	2	2	2
Mvmt Flow	333	416	352	20	9	184

























Major/Minor	Major1	Major2	Minor2		
Conflicting Flow All	372	0	-	0	1444 362
Stage 1	-	-	-	-	362 -
Stage 2	-	-	-	-	1082 -
Critical Hdwy	4.12	-	-	-	6.42 6.22
Critical Hdwy Stg 1	-	-	-	-	5.42 -
Critical Hdwy Stg 2	-	-	-	-	5.42 -
Follow-up Hdwy	2.218	-	-	-	3.518 3.318
Pot Cap-1 Maneuver	1186	-	-	-	145 683
Stage 1	-	-	-	-	704 -
Stage 2	-	-	-	-	325 -
Platoon blocked, %		-	-	-	
Mov Cap-1 Maneuver	1186	-	-	-	92 683
Mov Cap-2 Maneuver	-	-	-	-	92 -
Stage 1	-	-	-	-	447 -
Stage 2	-	-	-	-	325 -

Approach	EB	WB	SB
HCM Control Delay, s	4.1	0	13.9
HCM LOS			B

Minor Lane/Major Mvmt	EBL	EBT	WBT	WBR	SBLn1	SBLn2
Capacity (veh/h)	1186	-	-	-	92	683
HCM Lane V/C Ratio	0.281	-	-	-	0.097	0.27
HCM Control Delay (s)	9.2	0	-	-	48.3	12.2
HCM Lane LOS	A	A	-	-	E	B
HCM 95th %tile Q(veh)	1.2	-	-	-	0.3	1.1

HCM 2010 Signalized Intersection Summary
4: Old Highway 395 & Highway 76

Existing AM Peak Hour
07/10/2019

												
Movement	EBL	EBT	EBR	WBL	WBT	WBR	NBL	NBT	NBR	SBL	SBT	SBR
Lane Configurations												
Traffic Volume (veh/h)	79	688	154	245	1098	79	159	68	45	126	307	154
Future Volume (veh/h)	79	688	154	245	1098	79	159	68	45	126	307	154
Number	5	2	12	1	6	16	3	8	18	7	4	14
Initial Q (Qb), veh	0	0	0	0	0	0	0	0	0	0	0	0
Ped-Bike Adj(A_pbT)	1.00		1.00	1.00		1.00	1.00		1.00	1.00		1.00
Parking Bus, Adj	1.00	1.00	1.00	1.00	1.00	1.00	1.00	1.00	1.00	1.00	1.00	1.00
Adj Sat Flow, veh/h/ln	1863	1863	1863	1863	1863	1863	1863	1863	1863	1863	1863	1900
Adj Flow Rate, veh/h	82	717	59	255	1144	0	166	71	-27	131	320	155
Adj No. of Lanes	1	3	1	1	2	1	1	1	1	2	1	0
Peak Hour Factor	0.96	0.96	0.96	0.96	0.96	0.96	0.96	0.96	0.96	0.96	0.96	0.96
Percent Heavy Veh, %	2	2	2	2	2	2	2	2	2	2	2	2
Cap, veh/h	167	1488	463	276	1253	1033	188	164	386	1026	345	167
Arrive On Green	0.09	0.29	0.29	0.16	0.35	0.00	0.11	0.09	0.00	0.30	0.29	0.29
Sat Flow, veh/h	1774	5085	1583	1774	3539	1583	1774	1863	1583	3442	1187	575
Grp Volume(v), veh/h	82	717	59	255	1144	0	166	71	-27	131	0	475
Grp Sat Flow(s),veh/h/ln	1774	1695	1583	1774	1770	1583	1774	1863	1583	1721	0	1761
Q Serve(g_s), s	7.5	19.8	4.7	24.1	52.5	0.0	15.7	6.2	0.0	4.7	0.0	44.6
Cycle Q Clear(g_c), s	7.5	19.8	4.7	24.1	52.5	0.0	15.7	6.2	0.0	4.7	0.0	44.6
Prop In Lane	1.00		1.00	1.00		1.00	1.00		1.00	1.00		0.33
Lane Grp Cap(c), veh/h	167	1488	463	276	1253	1033	188	164	386	1026	0	512
V/C Ratio(X)	0.49	0.48	0.13	0.92	0.91	0.00	0.88	0.43	-0.07	0.13	0.00	0.93
Avail Cap(c_a), veh/h	281	1792	558	323	1351	1077	313	361	553	1026	0	662
HCM Platoon Ratio	1.00	1.00	1.00	1.00	1.00	1.00	1.00	1.00	1.00	1.00	1.00	1.00
Upstream Filter(I)	1.00	1.00	1.00	1.00	1.00	0.00	1.00	1.00	0.00	1.00	0.00	1.00
Uniform Delay (d), s/veh	73.2	49.6	44.2	70.9	52.5	0.0	75.0	73.6	0.0	43.6	0.0	58.6
Incr Delay (d2), s/veh	2.2	0.2	0.1	28.9	9.2	0.0	14.9	1.8	0.0	0.1	0.0	16.6
Initial Q Delay(d3),s/veh	0.0	0.0	0.0	0.0	0.0	0.0	0.0	0.0	0.0	0.0	0.0	0.0
%ile BackOfQ(50%),veh/ln	3.8	9.3	2.1	14.0	27.3	0.0	8.5	3.3	0.0	2.3	0.0	24.1
LnGrp Delay(d),s/veh	75.5	49.8	44.4	99.8	61.7	0.0	89.9	75.4	0.0	43.6	0.0	75.2
LnGrp LOS	E	D	D	F	E		F	E		D		E
Approach Vol, veh/h		858			1399			210			606	
Approach Delay, s/veh		51.9			68.7			96.6			68.4	
Approach LOS		D			E			F			E	
Timer	1	2	3	4	5	6	7	8				
Assigned Phs	1	2	3	4	5	6	7	8				
Phs Duration (G+Y+Rc), s	32.2	57.3	23.7	57.0	21.7	67.8	58.3	22.5				
Change Period (Y+Rc), s	* 5.7	7.5	* 5.7	7.5	* 5.7	7.5	7.5	* 7.5				
Max Green Setting (Gmax), s	* 31	60.0	* 30	64.0	* 27	65.0	48.0	* 33				
Max Q Clear Time (g_c+I1), s	26.1	21.8	17.7	46.6	9.5	54.5	6.7	8.2				
Green Ext Time (p_c), s	0.3	6.0	0.3	2.9	0.2	5.8	0.4	0.3				
Intersection Summary												
HCM 2010 Ctrl Delay			65.8									
HCM 2010 LOS			E									
Notes												

Intersection						
Int Delay, s/veh	8.6					
Movement	WBL	WBR	NBT	NBR	SBL	SBT
Lane Configurations						
Traffic Vol, veh/h	172	172	90	40	39	654
Future Vol, veh/h	172	172	90	40	39	654
Conflicting Peds, #/hr	0	0	0	0	0	0
Sign Control	Stop	Stop	Free	Free	Free	Free
RT Channelized	-	None	-	None	-	None
Storage Length	0	385	-	-	-	-
Veh in Median Storage, #	0	-	0	-	-	0
Grade, %	0	-	0	-	-	0
Peak Hour Factor	88	88	88	88	88	88
Heavy Vehicles, %	2	2	2	2	2	2
Mvmt Flow	195	195	102	45	44	743

Major/Minor	Minor1	Major1	Major2			
Conflicting Flow All	956	125	0	0	147	0
Stage 1	125	-	-	-	-	-
Stage 2	831	-	-	-	-	-
Critical Hdwy	6.42	6.22	-	-	4.12	-
Critical Hdwy Stg 1	5.42	-	-	-	-	-
Critical Hdwy Stg 2	5.42	-	-	-	-	-
Follow-up Hdwy	3.518	3.318	-	-	2.218	-
Pot Cap-1 Maneuver	286	926	-	-	1435	-
Stage 1	901	-	-	-	-	-
Stage 2	428	-	-	-	-	-
Platoon blocked, %			-	-	-	-
Mov Cap-1 Maneuver	271	926	-	-	1435	-
Mov Cap-2 Maneuver	271	-	-	-	-	-
Stage 1	854	-	-	-	-	-
Stage 2	428	-	-	-	-	-

Approach	WB	NB	SB
HCM Control Delay, s	28.2	0	0.4
HCM LOS	D		

Minor Lane/Major Mvmt	NBT	NBRWBLn1	WBLn2	SBL	SBT
Capacity (veh/h)	-	-	271	926	1435
HCM Lane V/C Ratio	-	-	0.721	0.211	0.031
HCM Control Delay (s)	-	-	46.4	9.9	7.6
HCM Lane LOS	-	-	E	A	A
HCM 95th %tile Q(veh)	-	-	5.1	0.8	0.1

Intersection												
Int Delay, s/veh	5.2											
Movement	EBL	EBT	EBR	WBL	WBT	WBR	NBL	NBT	NBR	SBL	SBT	SBR
Lane Configurations		↕	↗		↕	↗	↗	↗		↗	↕↗	
Traffic Vol, veh/h	80	7	64	24	22	15	59	40	8	17	586	100
Future Vol, veh/h	80	7	64	24	22	15	59	40	8	17	586	100
Conflicting Peds, #/hr	0	0	0	0	0	0	0	0	0	0	0	0
Sign Control	Stop	Stop	Stop	Stop	Stop	Stop	Free	Free	Free	Free	Free	Free
RT Channelized	-	-	Stop	-	-	Stop	-	-	None	-	-	None
Storage Length	-	-	25	-	-	50	210	-	-	200	-	530
Veh in Median Storage, #	-	0	-	-	0	-	-	0	-	-	0	-
Grade, %	-	0	-	-	0	-	-	0	-	-	0	-
Peak Hour Factor	95	95	95	95	95	95	95	95	95	95	95	95
Heavy Vehicles, %	2	2	2	2	2	2	2	2	2	2	2	2
Mvmt Flow	84	7	67	25	23	16	62	42	8	18	617	105

Major/Minor	Minor2		Minor1		Major1		Major2					
Conflicting Flow All	888	880	361	518	928	46	722	0	0	50	0	0
Stage 1	706	706	-	170	170	-	-	-	-	-	-	-
Stage 2	182	174	-	348	758	-	-	-	-	-	-	-
Critical Hdwy	7.33	6.53	6.93	7.33	6.53	6.23	4.13	-	-	4.13	-	-
Critical Hdwy Stg 1	6.53	5.53	-	6.13	5.53	-	-	-	-	-	-	-
Critical Hdwy Stg 2	6.13	5.53	-	6.53	5.53	-	-	-	-	-	-	-
Follow-up Hdwy	3.519	4.019	3.319	3.519	4.019	3.319	2.219	-	-	2.219	-	-
Pot Cap-1 Maneuver	251	285	636	454	267	1023	878	-	-	1556	-	-
Stage 1	394	438	-	831	757	-	-	-	-	-	-	-
Stage 2	819	754	-	642	414	-	-	-	-	-	-	-
Platoon blocked, %								-	-	-	-	-
Mov Cap-1 Maneuver	215	262	636	373	245	1023	878	-	-	1556	-	-
Mov Cap-2 Maneuver	215	262	-	373	245	-	-	-	-	-	-	-
Stage 1	366	433	-	772	703	-	-	-	-	-	-	-
Stage 2	725	700	-	558	409	-	-	-	-	-	-	-

Approach	EB		WB		NB		SB	
HCM Control Delay, s	23.8		16.7		5.2		0.2	
HCM LOS	C		C					

Minor Lane/Major Mvmt	NBL	NBT	NBR	EBLn1	EBLn2	WBLn1	WBLn2	SBL	SBT	SBR
Capacity (veh/h)	878	-	-	218	636	298	1023	1556	-	-
HCM Lane V/C Ratio	0.071	-	-	0.42	0.106	0.162	0.015	0.012	-	-
HCM Control Delay (s)	9.4	-	-	33	11.3	19.4	8.6	7.3	-	-
HCM Lane LOS	A	-	-	D	B	C	A	A	-	-
HCM 95th %tile Q(veh)	0.2	-	-	1.9	0.4	0.6	0	0	-	-

Intersection												
Int Delay, s/veh	5.2											
Movement	EBL	EBT	EBR	WBL	WBT	WBR	NBL	NBT	NBR	SBL	SBT	SBR
Lane Configurations		↑	↗	↘	↑						↖	↗
Traffic Vol, veh/h	0	311	381	7	123	0	0	0	0	185	12	7
Future Vol, veh/h	0	311	381	7	123	0	0	0	0	185	12	7
Conflicting Peds, #/hr	0	0	0	0	0	0	0	0	0	0	0	0
Sign Control	Free	Free	Free	Free	Free	Free	Stop	Stop	Stop	Stop	Stop	Stop
RT Channelized	-	-	Free	-	-	None	-	-	None	-	-	Yield
Storage Length	-	-	390	55	-	-	-	-	-	-	-	32
Veh in Median Storage, #	-	0	-	-	0	-	-	-	-	-	0	-
Grade, %	-	0	-	-	0	-	-	0	-	-	0	-
Peak Hour Factor	90	90	90	90	90	90	90	90	90	90	90	90
Heavy Vehicles, %	2	2	2	2	2	2	2	2	2	2	2	2
Mvmt Flow	0	346	423	8	137	0	0	0	0	206	13	8

Major/Minor	Major1			Major2			Minor2			
Conflicting Flow All	-	0	-	346	0	0		499	499	137
Stage 1	-	-	-	-	-	-		153	153	-
Stage 2	-	-	-	-	-	-		346	346	-
Critical Hdwy	-	-	-	4.12	-	-		6.42	6.52	6.22
Critical Hdwy Stg 1	-	-	-	-	-	-		5.42	5.52	-
Critical Hdwy Stg 2	-	-	-	-	-	-		5.42	5.52	-
Follow-up Hdwy	-	-	-	2.218	-	-		3.518	4.018	3.318
Pot Cap-1 Maneuver	0	-	0	1213	-	0		531	473	911
Stage 1	0	-	0	-	-	0		875	771	-
Stage 2	0	-	0	-	-	0		716	635	-
Platoon blocked, %	-	-	-	-	-	-		-	-	-
Mov Cap-1 Maneuver	-	-	-	1213	-	-		527	0	911
Mov Cap-2 Maneuver	-	-	-	-	-	-		527	0	-
Stage 1	-	-	-	-	-	-		869	0	-
Stage 2	-	-	-	-	-	-		716	0	-

Approach	EB	WB	SB
HCM Control Delay, s	0	0.4	16.3
HCM LOS			C

Minor Lane/Major Mvmt	EBT	WBL	WBT	SBLn1	SBLn2
Capacity (veh/h)	-	1213	-	527	911
HCM Lane V/C Ratio	-	0.006	-	0.415	0.009
HCM Control Delay (s)	-	8	-	16.6	9
HCM Lane LOS	-	A	-	C	A
HCM 95th %tile Q(veh)	-	0	-	2	0

Intersection												
Int Delay, s/veh	2.1											
Movement	EBL	EBT	EBR	WBL	WBT	WBR	NBL	NBT	NBR	SBL	SBT	SBR
Lane Configurations		↑	↑		↑	↑	↑		↑			
Traffic Vol, veh/h	0	488	5	0	42	49	81	0	4	0	0	0
Future Vol, veh/h	0	488	5	0	42	49	81	0	4	0	0	0
Conflicting Peds, #/hr	0	0	0	0	0	0	0	0	0	0	0	0
Sign Control	Free	Free	Free	Free	Free	Free	Stop	Stop	Stop	Stop	Stop	Stop
RT Channelized	-	-	Free	-	-	Free	-	-	Stop	-	-	None
Storage Length	-	-	200	-	-	100	0	-	150	-	-	-
Veh in Median Storage, #	-	0	-	-	0	-	-	0	-	-	16965	-
Grade, %	-	0	-	-	0	-	-	0	-	-	0	-
Peak Hour Factor	83	83	83	83	83	83	83	83	83	83	83	83
Heavy Vehicles, %	2	2	2	2	2	2	2	2	2	2	2	2
Mvmt Flow	0	588	6	0	51	59	98	0	5	0	0	0

Major/Minor	Major1		Major2		Minor1				
Conflicting Flow All	-	0	-	-	0	639	-	588	
Stage 1	-	-	-	-	-	588	-	-	
Stage 2	-	-	-	-	-	51	-	-	
Critical Hdwy	-	-	-	-	-	6.42	-	6.22	
Critical Hdwy Stg 1	-	-	-	-	-	5.42	-	-	
Critical Hdwy Stg 2	-	-	-	-	-	5.42	-	-	
Follow-up Hdwy	-	-	-	-	-	3.518	-	3.318	
Pot Cap-1 Maneuver	0	-	0	0	-	0	440	0	509
Stage 1	0	-	0	0	-	0	555	0	-
Stage 2	0	-	0	0	-	0	971	0	-
Platoon blocked, %	-	-	-	-	-	-	-	-	-
Mov Cap-1 Maneuver	-	-	-	-	-	-	440	0	509
Mov Cap-2 Maneuver	-	-	-	-	-	-	440	0	-
Stage 1	-	-	-	-	-	-	555	0	-
Stage 2	-	-	-	-	-	-	971	0	-

Approach	EB	WB	NB
HCM Control Delay, s	0	0	15.3
HCM LOS			C

Minor Lane/Major Mvmt	NBLn1	NBLn2	EBT	WBT
Capacity (veh/h)	440	509	-	-
HCM Lane V/C Ratio	0.222	0.009	-	-
HCM Control Delay (s)	15.5	12.1	-	-
HCM Lane LOS	C	B	-	-
HCM 95th %tile Q(veh)	0.8	0	-	-

Intersection						
Int Delay, s/veh	8.6					
Movement	EBL	EBR	NBL	NBT	SBT	SBR
Lane Configurations	Y		Y	↑	↑	Y
Traffic Vol, veh/h	20	280	127	62	511	36
Future Vol, veh/h	20	280	127	62	511	36
Conflicting Peds, #/hr	0	0	0	0	0	0
Sign Control	Stop	Stop	Free	Free	Free	Free
RT Channelized	-	None	-	None	-	None
Storage Length	0	-	110	-	-	50
Veh in Median Storage, #	0	-	-	0	0	-
Grade, %	0	-	-	0	0	-
Peak Hour Factor	91	91	91	91	91	91
Heavy Vehicles, %	2	2	2	2	2	2
Mvmt Flow	22	308	140	68	562	40

Major/Minor	Minor2	Major1	Major2			
Conflicting Flow All	910	562	602	0	-	0
Stage 1	562	-	-	-	-	-
Stage 2	348	-	-	-	-	-
Critical Hdwy	6.42	6.22	4.12	-	-	-
Critical Hdwy Stg 1	5.42	-	-	-	-	-
Critical Hdwy Stg 2	5.42	-	-	-	-	-
Follow-up Hdwy	3.518	3.318	2.218	-	-	-
Pot Cap-1 Maneuver	305	526	975	-	-	-
Stage 1	571	-	-	-	-	-
Stage 2	715	-	-	-	-	-
Platoon blocked, %				-	-	-
Mov Cap-1 Maneuver	261	526	975	-	-	-
Mov Cap-2 Maneuver	261	-	-	-	-	-
Stage 1	489	-	-	-	-	-
Stage 2	715	-	-	-	-	-

Approach	EB	NB	SB
HCM Control Delay, s	25.8	6.3	0
HCM LOS	D		

Minor Lane/Major Mvmt	NBL	NBT	EBLn1	SBT	SBR
Capacity (veh/h)	975	-	493	-	-
HCM Lane V/C Ratio	0.143	-	0.669	-	-
HCM Control Delay (s)	9.3	-	25.8	-	-
HCM Lane LOS	A	-	D	-	-
HCM 95th %tile Q(veh)	0.5	-	4.9	-	-













Intersection						
Int Delay, s/veh	35					
Movement	WBL	WBR	NBT	NBR	SBL	SBT
Lane Configurations	W		T		T	T
Traffic Vol, veh/h	243	31	169	77	16	812
Future Vol, veh/h	243	31	169	77	16	812
Conflicting Peds, #/hr	0	0	0	0	0	0
Sign Control	Stop	Stop	Free	Free	Free	Free
RT Channelized	-	None	-	None	-	None
Storage Length	0	-	-	-	165	-
Veh in Median Storage, #	0	-	0	-	-	0
Grade, %	0	-	0	-	-	0
Peak Hour Factor	93	93	93	93	93	93
Heavy Vehicles, %	2	2	2	2	2	2
Mvmt Flow	261	33	182	83	17	873

Major/Minor	Minor1	Major1	Major2		
Conflicting Flow All	1131	224	0	0	265
Stage 1	224	-	-	-	-
Stage 2	907	-	-	-	-
Critical Hdwy	6.42	6.22	-	-	4.12
Critical Hdwy Stg 1	5.42	-	-	-	-
Critical Hdwy Stg 2	5.42	-	-	-	-
Follow-up Hdwy	3.518	3.318	-	-	2.218
Pot Cap-1 Maneuver	~ 225	815	-	-	1299
Stage 1	813	-	-	-	-
Stage 2	394	-	-	-	-
Platoon blocked, %			-	-	-
Mov Cap-1 Maneuver	~ 222	815	-	-	1299
Mov Cap-2 Maneuver	~ 222	-	-	-	-
Stage 1	802	-	-	-	-
Stage 2	394	-	-	-	-

Approach	WB	NB	SB
HCM Control Delay, s	171.5	0	0.2
HCM LOS	F		

Minor Lane/Major Mvmt	NBT	NBRWBLn1	SBL	SBT
Capacity (veh/h)	-	-	242	1299
HCM Lane V/C Ratio	-	-	1.217	0.013
HCM Control Delay (s)	-	-	171.5	7.8
HCM Lane LOS	-	-	F	A
HCM 95th %tile Q(veh)	-	-	14.3	0

Notes
 -: Volume exceeds capacity \$: Delay exceeds 300s +: Computation Not Defined *: All major volume in platoon

								
Movement	EBL	EBR	NBL	NBT	SBT	SBR		
Lane Configurations								
Traffic Volume (veh/h)	148	170	287	98	514	538		
Future Volume (veh/h)	148	170	287	98	514	538		
Number	7	14	5	2	6	16		
Initial Q (Qb), veh	0	0	0	0	0	0		
Ped-Bike Adj(A_pbT)	1.00	1.00	1.00			1.00		
Parking Bus, Adj	1.00	1.00	1.00	1.00	1.00	1.00		
Adj Sat Flow, veh/h/ln	1863	1863	1863	1863	1863	1863		
Adj Flow Rate, veh/h	163	187	315	108	565	591		
Adj No. of Lanes	1	1	1	1	1	1		
Peak Hour Factor	0.91	0.91	0.91	0.91	0.91	0.91		
Percent Heavy Veh, %	2	2	2	2	2	2		
Cap, veh/h	240	542	368	1339	817	694		
Arrive On Green	0.14	0.14	0.21	0.72	0.44	0.44		
Sat Flow, veh/h	1774	1583	1774	1863	1863	1583		
Grp Volume(v), veh/h	163	187	315	108	565	591		
Grp Sat Flow(s),veh/h/ln	1774	1583	1774	1863	1863	1583		
Q Serve(g_s), s	4.8	4.8	9.4	0.9	13.4	18.3		
Cycle Q Clear(g_c), s	4.8	4.8	9.4	0.9	13.4	18.3		
Prop In Lane	1.00	1.00	1.00			1.00		
Lane Grp Cap(c), veh/h	240	542	368	1339	817	694		
V/C Ratio(X)	0.68	0.35	0.86	0.08	0.69	0.85		
Avail Cap(c_a), veh/h	421	704	389	1496	952	809		
HCM Platoon Ratio	1.00	1.00	1.00	1.00	1.00	1.00		
Upstream Filter(I)	1.00	1.00	1.00	1.00	1.00	1.00		
Uniform Delay (d), s/veh	22.6	13.4	20.9	2.3	12.4	13.8		
Incr Delay (d2), s/veh	3.4	0.4	16.4	0.0	1.8	7.7		
Initial Q Delay(d3),s/veh	0.0	0.0	0.0	0.0	0.0	0.0		
%ile BackOfQ(50%),veh/ln	2.6	4.7	6.2	0.5	7.1	9.4		
LnGrp Delay(d),s/veh	25.9	13.8	37.3	2.3	14.2	21.4		
LnGrp LOS	C	B	D	A	B	C		
Approach Vol, veh/h	350			423	1156			
Approach Delay, s/veh	19.5			28.4	17.9			
Approach LOS	B			C	B			
Timer	1	2	3	4	5	6	7	8
Assigned Phs	2		4		5	6		
Phs Duration (G+Y+Rc), s	43.4		11.4		15.4	28.0		
Change Period (Y+Rc), s	4.0		4.0		4.0	4.0		
Max Green Setting (Gmax), s	44.0		13.0		12.0	28.0		
Max Q Clear Time (g_c+I1), s	2.9		6.8		11.4	20.3		
Green Ext Time (p_c), s	0.6		0.6		0.1	3.7		
Intersection Summary								
HCM 2010 Ctrl Delay			20.5					
HCM 2010 LOS			C					

Intersection												
Int Delay, s/veh	3.8											
Movement	EBL	EBT	EBR	WBL	WBT	WBR	NBL	NBT	NBR	SBL	SBT	SBR
Lane Configurations		↕			↕			↕			↕	
Traffic Vol, veh/h	11	0	5	3	1	2	5	13	4	2	16	3
Future Vol, veh/h	11	0	5	3	1	2	5	13	4	2	16	3
Conflicting Peds, #/hr	0	0	0	0	0	0	0	0	0	0	0	0
Sign Control	Stop	Stop	Stop	Stop	Stop	Stop	Free	Free	Free	Free	Free	Free
RT Channelized	-	-	None	-	-	None	-	-	None	-	-	None
Storage Length	-	-	-	-	-	-	-	-	-	-	-	-
Veh in Median Storage, #	-	0	-	-	0	-	-	0	-	-	0	-
Grade, %	-	0	-	-	0	-	-	0	-	-	0	-
Peak Hour Factor	86	86	86	86	86	86	86	86	86	86	86	86
Heavy Vehicles, %	2	2	2	2	2	2	2	2	2	2	2	2
Mvmt Flow	13	0	6	3	1	2	6	15	5	2	19	3

Major/Minor	Minor2		Minor1		Major1		Major2					
Conflicting Flow All	56	57	21	58	56	18	22	0	0	20	0	0
Stage 1	25	25	-	30	30	-	-	-	-	-	-	-
Stage 2	31	32	-	28	26	-	-	-	-	-	-	-
Critical Hdwy	7.12	6.52	6.22	7.12	6.52	6.22	4.12	-	-	4.12	-	-
Critical Hdwy Stg 1	6.12	5.52	-	6.12	5.52	-	-	-	-	-	-	-
Critical Hdwy Stg 2	6.12	5.52	-	6.12	5.52	-	-	-	-	-	-	-
Follow-up Hdwy	3.518	4.018	3.318	3.518	4.018	3.318	2.218	-	-	2.218	-	-
Pot Cap-1 Maneuver	941	834	1056	939	835	1061	1593	-	-	1596	-	-
Stage 1	993	874	-	987	870	-	-	-	-	-	-	-
Stage 2	986	868	-	989	874	-	-	-	-	-	-	-
Platoon blocked, %								-	-	-	-	-
Mov Cap-1 Maneuver	934	830	1056	931	831	1061	1593	-	-	1596	-	-
Mov Cap-2 Maneuver	934	830	-	931	831	-	-	-	-	-	-	-
Stage 1	989	873	-	983	867	-	-	-	-	-	-	-
Stage 2	979	865	-	983	873	-	-	-	-	-	-	-

Approach	EB		WB		NB		SB	
HCM Control Delay, s	8.8		8.8		1.7		0.7	
HCM LOS	A		A					

Minor Lane/Major Mvmt	NBL	NBT	NBR	EBLn1	WBLn1	SBL	SBT	SBR
Capacity (veh/h)	1593	-	-	969	951	1596	-	-
HCM Lane V/C Ratio	0.004	-	-	0.019	0.007	0.001	-	-
HCM Control Delay (s)	7.3	0	-	8.8	8.8	7.3	0	-
HCM Lane LOS	A	A	-	A	A	A	A	-
HCM 95th %tile Q(veh)	0	-	-	0.1	0	0	-	-

Intersection						
Int Delay, s/veh	4.9					
Movement	WBL	WBR	NBT	NBR	SBL	SBT
Lane Configurations	W		T			T
Traffic Vol, veh/h	63	9	13	30	19	34
Future Vol, veh/h	63	9	13	30	19	34
Conflicting Peds, #/hr	0	0	0	0	0	0
Sign Control	Stop	Stop	Free	Free	Free	Free
RT Channelized	-	None	-	None	-	None
Storage Length	0	-	-	-	-	-
Veh in Median Storage, #	0	-	0	-	-	0
Grade, %	0	-	0	-	-	0
Peak Hour Factor	86	86	86	86	86	86
Heavy Vehicles, %	2	2	2	2	2	2
Mvmt Flow	73	10	15	35	22	40

Major/Minor	Minor1	Major1	Major2			
Conflicting Flow All	117	33	0	0	50	0
Stage 1	33	-	-	-	-	-
Stage 2	84	-	-	-	-	-
Critical Hdwy	6.42	6.22	-	-	4.12	-
Critical Hdwy Stg 1	5.42	-	-	-	-	-
Critical Hdwy Stg 2	5.42	-	-	-	-	-
Follow-up Hdwy	3.518	3.318	-	-	2.218	-
Pot Cap-1 Maneuver	879	1041	-	-	1557	-
Stage 1	989	-	-	-	-	-
Stage 2	939	-	-	-	-	-
Platoon blocked, %			-	-		-
Mov Cap-1 Maneuver	867	1041	-	-	1557	-
Mov Cap-2 Maneuver	867	-	-	-	-	-
Stage 1	975	-	-	-	-	-
Stage 2	939	-	-	-	-	-

Approach	WB	NB	SB
HCM Control Delay, s	9.5	0	2.6
HCM LOS	A		

Minor Lane/Major Mvmt	NBT	NBRWBLn1	SBL	SBT
Capacity (veh/h)	-	-	886	1557
HCM Lane V/C Ratio	-	-	0.094	0.014
HCM Control Delay (s)	-	-	9.5	7.3
HCM Lane LOS	-	-	A	A
HCM 95th %tile Q(veh)	-	-	0.3	0

Intersection						
Int Delay, s/veh	2.7					
Movement	EBL	EBR	NBL	NBT	SBT	SBR
Lane Configurations	T			T		T
Traffic Vol, veh/h	8	49	21	54	88	41
Future Vol, veh/h	8	49	21	54	88	41
Conflicting Peds, #/hr	0	0	0	0	0	0
Sign Control	Stop	Stop	Free	Free	Free	Free
RT Channelized	-	None	-	None	-	None
Storage Length	0	-	-	-	-	-
Veh in Median Storage, #	0	-	-	0	0	-
Grade, %	0	-	-	0	0	-
Peak Hour Factor	85	85	85	85	85	85
Heavy Vehicles, %	2	2	2	2	2	2
Mvmt Flow	9	58	25	64	104	48

Major/Minor	Minor2	Major1		Major2	
Conflicting Flow All	242	128	152	0	0
Stage 1	128	-	-	-	-
Stage 2	114	-	-	-	-
Critical Hdwy	6.42	6.22	4.12	-	-
Critical Hdwy Stg 1	5.42	-	-	-	-
Critical Hdwy Stg 2	5.42	-	-	-	-
Follow-up Hdwy	3.518	3.318	2.218	-	-
Pot Cap-1 Maneuver	746	922	1429	-	-
Stage 1	898	-	-	-	-
Stage 2	911	-	-	-	-
Platoon blocked, %				-	-
Mov Cap-1 Maneuver	733	922	1429	-	-
Mov Cap-2 Maneuver	733	-	-	-	-
Stage 1	882	-	-	-	-
Stage 2	911	-	-	-	-

Approach	EB	NB	SB
HCM Control Delay, s	9.4	2.1	0
HCM LOS	A		

Minor Lane/Major Mvmt	NBL	NBT	EBLn1	SBT	SBR
Capacity (veh/h)	1429	-	890	-	-
HCM Lane V/C Ratio	0.017	-	0.075	-	-
HCM Control Delay (s)	7.6	0	9.4	-	-
HCM Lane LOS	A	A	A	-	-
HCM 95th %tile Q(veh)	0.1	-	0.2	-	-

Intersection						
Int Delay, s/veh	7.2					
Movement	EBL	EBT	WBT	WBR	SBL	SBR
Lane Configurations	↘	↗	↗	↘	↘	↘
Traffic Vol, veh/h	71	156	263	148	180	90
Future Vol, veh/h	71	156	263	148	180	90
Conflicting Peds, #/hr	0	0	0	0	0	0
Sign Control	Free	Free	Free	Free	Stop	Stop
RT Channelized	-	None	-	None	-	None
Storage Length	165	-	-	80	0	-
Veh in Median Storage, #	-	0	0	-	0	-
Grade, %	-	0	0	-	0	-
Peak Hour Factor	92	92	92	92	92	92
Heavy Vehicles, %	2	2	2	2	2	2
Mvmt Flow	77	170	286	161	196	98























Major/Minor	Major1	Major2	Minor2		
Conflicting Flow All	447	0	-	0	610 286
Stage 1	-	-	-	-	286 -
Stage 2	-	-	-	-	324 -
Critical Hdwy	4.12	-	-	-	6.42 6.22
Critical Hdwy Stg 1	-	-	-	-	5.42 -
Critical Hdwy Stg 2	-	-	-	-	5.42 -
Follow-up Hdwy	2.218	-	-	-	3.518 3.318
Pot Cap-1 Maneuver	1113	-	-	-	458 753
Stage 1	-	-	-	-	763 -
Stage 2	-	-	-	-	733 -
Platoon blocked, %		-	-	-	
Mov Cap-1 Maneuver	1113	-	-	-	426 753
Mov Cap-2 Maneuver	-	-	-	-	426 -
Stage 1	-	-	-	-	710 -
Stage 2	-	-	-	-	733 -

Approach	EB	WB	SB
HCM Control Delay, s	2.7	0	22.1
HCM LOS			C

Minor Lane/Major Mvmt	EBL	EBT	WBT	WBR	SBLn1
Capacity (veh/h)	1113	-	-	-	498
HCM Lane V/C Ratio	0.069	-	-	-	0.589
HCM Control Delay (s)	8.5	-	-	-	22.1
HCM Lane LOS	A	-	-	-	C
HCM 95th %tile Q(veh)	0.2	-	-	-	3.8

HCM 2010 Signalized Intersection Summary
 16: SR-76 & Old River Rd/East Vista Way

Existing AM Peak Hour
 07/10/2019

												
Movement	EBL	EBT	EBR	WBL	WBT	WBR	NBL	NBT	NBR	SBL	SBT	SBR
Lane Configurations												
Traffic Volume (veh/h)	7	141	151	254	24	338	68	763	342	532	1449	63
Future Volume (veh/h)	7	141	151	254	24	338	68	763	342	532	1449	63
Number	7	4	14	3	8	18	5	2	12	1	6	16
Initial Q (Qb), veh	0	0	0	0	0	0	0	0	0	0	0	0
Ped-Bike Adj(A_pbT)	1.00		1.00	1.00		1.00	1.00		1.00	1.00		1.00
Parking Bus, Adj	1.00	1.00	1.00	1.00	1.00	1.00	1.00	1.00	1.00	1.00	1.00	1.00
Adj Sat Flow, veh/h/ln	1900	1863	1900	1863	1863	1863	1863	1863	1863	1863	1863	1900
Adj Flow Rate, veh/h	7	147	157	283	0	352	71	795	356	554	1509	66
Adj No. of Lanes	0	2	0	2	0	1	1	3	1	2	3	0
Peak Hour Factor	0.96	0.96	0.96	0.96	0.96	0.96	0.96	0.96	0.96	0.96	0.96	0.96
Percent Heavy Veh, %	2	2	2	2	2	2	2	2	2	2	2	2
Cap, veh/h	10	220	196	725	0	619	125	1464	456	641	2018	88
Arrive On Green	0.12	0.12	0.12	0.20	0.00	0.20	0.07	0.29	0.29	0.19	0.40	0.40
Sat Flow, veh/h	84	1774	1583	3548	0	1583	1774	5085	1583	3442	4996	218
Grp Volume(v), veh/h	154	0	157	283	0	352	71	795	356	554	1024	551
Grp Sat Flow(s),veh/h/ln	1859	0	1583	1774	0	1583	1774	1695	1583	1721	1695	1824
Q Serve(g_s), s	10.4	0.0	12.7	9.1	0.0	22.9	5.1	17.4	27.2	20.6	34.0	34.0
Cycle Q Clear(g_c), s	10.4	0.0	12.7	9.1	0.0	22.9	5.1	17.4	27.2	20.6	34.0	34.0
Prop In Lane	0.05		1.00	1.00		1.00	1.00		1.00	1.00		0.12
Lane Grp Cap(c), veh/h	230	0	196	725	0	619	125	1464	456	641	1370	737
V/C Ratio(X)	0.67	0.00	0.80	0.39	0.00	0.57	0.57	0.54	0.78	0.86	0.75	0.75
Avail Cap(c_a), veh/h	423	0	361	1024	0	752	404	3399	1058	1098	2240	1205
HCM Platoon Ratio	1.00	1.00	1.00	1.00	1.00	1.00	1.00	1.00	1.00	1.00	1.00	1.00
Upstream Filter(I)	1.00	0.00	1.00	1.00	0.00	1.00	1.00	1.00	1.00	1.00	1.00	1.00
Uniform Delay (d), s/veh	55.1	0.0	56.1	45.3	0.0	31.4	59.3	39.6	43.1	51.9	33.5	33.5
Incr Delay (d2), s/veh	3.3	0.0	7.4	0.3	0.0	0.8	4.0	0.3	3.0	3.7	0.8	1.5
Initial Q Delay(d3),s/veh	0.0	0.0	0.0	0.0	0.0	0.0	0.0	0.0	0.0	0.0	0.0	0.0
%ile BackOfQ(50%),veh/ln	5.6	0.0	5.9	4.5	0.0	10.1	2.6	8.1	12.2	10.1	16.1	17.5
LnGrp Delay(d),s/veh	58.4	0.0	63.5	45.6	0.0	32.2	63.3	39.9	46.0	55.7	34.3	35.0
LnGrp LOS	E		E	D		C	E	D	D	E	C	D
Approach Vol, veh/h		311			635			1222			2129	
Approach Delay, s/veh		61.0			38.2			43.0			40.1	
Approach LOS		E			D			D			D	
Timer	1	2	3	4	5	6	7	8				
Assigned Phs	1	2		4	5	6		8				
Phs Duration (G+Y+Rc), s	30.2	45.4		22.7	15.0	60.7		33.3				
Change Period (Y+Rc), s	* 5.7	7.5		6.4	* 5.7	7.5		6.4				
Max Green Setting (Gmax), s	* 42	88.0		30.0	* 30	87.0		38.0				
Max Q Clear Time (g_c+I1), s	22.6	29.2		14.7	7.1	36.0		24.9				
Green Ext Time (p_c), s	2.0	8.7		1.6	0.1	17.2		2.0				
Intersection Summary												
HCM 2010 Ctrl Delay				42.1								
HCM 2010 LOS				D								
Notes												

HCM 2010 Signalized Intersection Summary
 17: SR-76 & N River Rd

Existing AM Peak Hour
 07/10/2019



Movement	EBL	EBR	NBL	NBT	SBT	SBR		
Lane Configurations								
Traffic Volume (veh/h)	179	143	138	1068	1867	542		
Future Volume (veh/h)	179	143	138	1068	1867	542		
Number	7	14	5	2	6	16		
Initial Q (Qb), veh	0	0	0	0	0	0		
Ped-Bike Adj(A_pbT)	1.00	1.00	1.00			1.00		
Parking Bus, Adj	1.00	1.00	1.00	1.00	1.00	1.00		
Adj Sat Flow, veh/h/ln	1863	1863	1863	1863	1863	1863		
Adj Flow Rate, veh/h	188	151	145	1124	1965	571		
Adj No. of Lanes	1	1	1	2	2	1		
Peak Hour Factor	0.95	0.95	0.95	0.95	0.95	0.95		
Percent Heavy Veh, %	2	2	2	2	2	2		
Cap, veh/h	219	195	169	2796	2331	1043		
Arrive On Green	0.12	0.12	0.10	0.79	0.66	0.66		
Sat Flow, veh/h	1774	1583	1774	3632	3632	1583		
Grp Volume(v), veh/h	188	151	145	1124	1965	571		
Grp Sat Flow(s),veh/h/ln	1774	1583	1774	1770	1770	1583		
Q Serve(g_s), s	16.3	14.5	12.6	15.3	66.8	30.2		
Cycle Q Clear(g_c), s	16.3	14.5	12.6	15.3	66.8	30.2		
Prop In Lane	1.00	1.00	1.00			1.00		
Lane Grp Cap(c), veh/h	219	195	169	2796	2331	1043		
V/C Ratio(X)	0.86	0.77	0.86	0.40	0.84	0.55		
Avail Cap(c_a), veh/h	453	404	328	2796	2711	1213		
HCM Platoon Ratio	1.00	1.00	1.00	1.00	1.00	1.00		
Upstream Filter(I)	1.00	1.00	1.00	1.00	1.00	1.00		
Uniform Delay (d), s/veh	67.4	66.6	69.9	5.1	20.5	14.3		
Incr Delay (d2), s/veh	9.5	6.4	11.9	0.1	2.3	0.5		
Initial Q Delay(d3),s/veh	0.0	0.0	0.0	0.0	0.0	0.0		
%ile BackOfQ(50%),veh/ln	8.6	12.7	6.8	7.4	33.2	13.3		
LnGrp Delay(d),s/veh	76.9	73.0	81.8	5.2	22.8	14.7		
LnGrp LOS	E	E	F	A	C	B		
Approach Vol, veh/h	339			1269	2536			
Approach Delay, s/veh	75.2			13.9	21.0			
Approach LOS	E			B	C			
Timer	1	2	3	4	5	6	7	8
Assigned Phs		2		4	5	6		
Phs Duration (G+Y+Rc), s		131.3		25.4	20.6	110.7		
Change Period (Y+Rc), s		7.5		6.1	* 5.7	7.5		
Max Green Setting (Gmax), s		85.0		40.0	* 29	120.0		
Max Q Clear Time (g_c+I1), s		17.3		18.3	14.6	68.8		
Green Ext Time (p_c), s		11.5		1.0	0.3	34.4		
Intersection Summary								
HCM 2010 Ctrl Delay			23.3					
HCM 2010 LOS			C					
Notes								

HCM 2010 Signalized Intersection Summary
 18: SR-76 & Via Montellano

Existing AM Peak Hour
 07/10/2019



Movement	EBL	EBR	NBL	NBT	SBT	SBR		
Lane Configurations								
Traffic Volume (veh/h)	8	7	3	1296	2374	9		
Future Volume (veh/h)	8	7	3	1296	2374	9		
Number	7	14	5	2	6	16		
Initial Q (Qb), veh	0	0	0	0	0	0		
Ped-Bike Adj(A_pbT)	1.00	1.00	1.00			1.00		
Parking Bus, Adj	1.00	1.00	1.00	1.00	1.00	1.00		
Adj Sat Flow, veh/h/ln	1863	1900	1863	1863	1863	1863		
Adj Flow Rate, veh/h	8	7	3	1322	2422	9		
Adj No. of Lanes	0	0	1	2	2	1		
Peak Hour Factor	0.98	0.98	0.98	0.98	0.98	0.98		
Percent Heavy Veh, %	0	0	2	2	2	2		
Cap, veh/h	30	26	13	2956	2739	1225		
Arrive On Green	0.04	0.04	0.01	0.84	0.77	0.77		
Sat Flow, veh/h	845	739	1774	3632	3632	1583		
Grp Volume(v), veh/h	16	0	3	1322	2422	9		
Grp Sat Flow(s),veh/h/ln	1690	0	1774	1770	1770	1583		
Q Serve(g_s), s	1.0	0.0	0.2	10.3	51.6	0.1		
Cycle Q Clear(g_c), s	1.0	0.0	0.2	10.3	51.6	0.1		
Prop In Lane	0.50	0.44	1.00			1.00		
Lane Grp Cap(c), veh/h	60	0	13	2956	2739	1225		
V/C Ratio(X)	0.27	0.00	0.24	0.45	0.88	0.01		
Avail Cap(c_a), veh/h	546	0	405	2956	2926	1309		
HCM Platoon Ratio	1.00	1.00	1.00	1.00	1.00	1.00		
Upstream Filter(I)	1.00	0.00	1.00	1.00	1.00	1.00		
Uniform Delay (d), s/veh	49.4	0.0	52.0	2.3	8.5	2.7		
Incr Delay (d2), s/veh	2.3	0.0	9.2	0.1	3.4	0.0		
Initial Q Delay(d3),s/veh	0.0	0.0	0.0	0.0	0.0	0.0		
%ile BackOfQ(50%),veh/ln	0.5	0.0	0.1	5.0	25.9	0.1		
LnGrp Delay(d),s/veh	51.8	0.0	61.1	2.4	12.0	2.7		
LnGrp LOS	D		E	A	B	A		
Approach Vol, veh/h	16			1325	2431			
Approach Delay, s/veh	51.8			2.5	11.9			
Approach LOS	D			A	B			
Timer	1	2	3	4	5	6	7	8
Assigned Phs		2		4	5	6		
Phs Duration (G+Y+Rc), s		95.4		9.8	6.5	89.0		
Change Period (Y+Rc), s		7.5		6.1	* 5.7	7.5		
Max Green Setting (Gmax), s		85.0		34.0	* 24	87.0		
Max Q Clear Time (g_c+I1), s		12.3		3.0	2.2	53.6		
Green Ext Time (p_c), s		15.4		0.0	0.0	27.9		
Intersection Summary								
HCM 2010 Ctrl Delay			8.8					
HCM 2010 LOS			A					
Notes								

HCM 2010 Signalized Intersection Summary
 19: I-15 SB Ramps & Highway 76

Existing AM Peak Hour
 07/10/2019



Movement	EBL	EBT	EBR	WBL	WBT	WBR	NBL	NBT	NBR	SBL	SBT	SBR
Lane Configurations		↑↑↑	↗		↑↑	↗				↖	↔	↗
Traffic Volume (veh/h)	0	711	152	0	406	119	0	0	0	48	0	1344
Future Volume (veh/h)	0	711	152	0	406	119	0	0	0	48	0	1344
Number	5	2	12	1	6	16				7	4	14
Initial Q (Qb), veh	0	0	0	0	0	0				0	0	0
Ped-Bike Adj(A_pbT)	1.00		1.00	1.00		1.00				1.00		1.00
Parking Bus, Adj	1.00	1.00	1.00	1.00	1.00	1.00				1.00	1.00	1.00
Adj Sat Flow, veh/h/ln	0	1863	1863	0	1863	1863				1863	1863	1863
Adj Flow Rate, veh/h	0	781	167	0	446	131				35	0	1496
Adj No. of Lanes	0	3	1	0	2	1				1	0	2
Peak Hour Factor	0.91	0.91	0.91	0.91	0.91	0.91				0.91	0.91	0.91
Percent Heavy Veh, %	0	2	2	0	2	2				2	2	2
Cap, veh/h	0	1343	418	0	935	1280				966	0	1724
Arrive On Green	0.00	0.26	0.26	0.00	0.26	0.26				0.54	0.00	0.54
Sat Flow, veh/h	0	5253	1583	0	3632	1583				1774	0	3167
Grp Volume(v), veh/h	0	781	167	0	446	131				35	0	1496
Grp Sat Flow(s),veh/h/ln	0	1695	1583	0	1770	1583				1774	0	1583
Q Serve(g_s), s	0.0	9.5	6.2	0.0	7.5	1.2				0.7	0.0	29.0
Cycle Q Clear(g_c), s	0.0	9.5	6.2	0.0	7.5	1.2				0.7	0.0	29.0
Prop In Lane	0.00		1.00	0.00		1.00				1.00		1.00
Lane Grp Cap(c), veh/h	0	1343	418	0	935	1280				966	0	1724
V/C Ratio(X)	0.00	0.58	0.40	0.00	0.48	0.10				0.04	0.00	0.87
Avail Cap(c_a), veh/h	0	3937	1226	0	2890	2155				1249	0	2229
HCM Platoon Ratio	1.00	1.00	1.00	1.00	1.00	1.00				1.00	1.00	1.00
Upstream Filter(I)	0.00	1.00	1.00	0.00	1.00	1.00				1.00	0.00	1.00
Uniform Delay (d), s/veh	0.0	22.7	21.5	0.0	22.0	1.4				7.5	0.0	14.0
Incr Delay (d2), s/veh	0.0	0.4	0.6	0.0	0.4	0.0				0.0	0.0	3.2
Initial Q Delay(d3),s/veh	0.0	0.0	0.0	0.0	0.0	0.0				0.0	0.0	0.0
%ile BackOfQ(50%),veh/ln	0.0	4.5	2.8	0.0	3.7	2.1				0.3	0.0	13.2
LnGrp Delay(d),s/veh	0.0	23.1	22.1	0.0	22.4	1.5				7.5	0.0	17.1
LnGrp LOS		C	C		C	A				A		B
Approach Vol, veh/h		948			577						1531	
Approach Delay, s/veh		23.0			17.6						16.9	
Approach LOS		C			B						B	
Timer	1	2	3	4	5	6	7	8				
Assigned Phs		2		4		6						
Phs Duration (G+Y+Rc), s		26.3		44.8		26.3						
Change Period (Y+Rc), s		7.5		6.1		7.5						
Max Green Setting (Gmax), s		55.0		50.0		58.0						
Max Q Clear Time (g_c+I1), s		11.5		31.0		9.5						
Green Ext Time (p_c), s		7.3		7.7		3.8						
Intersection Summary												
HCM 2010 Ctrl Delay				18.9								
HCM 2010 LOS				B								
Notes												

HCM 2010 Signalized Intersection Summary
 20: I-15 NB Ramps & Highway 76































Existing AM Peak Hour
 07/10/2019



Movement	EBL	EBT	EBR	WBL	WBT	WBR	NBL	NBT	NBR	SBL	SBT	SBR
Lane Configurations		↑↑	↑		↑↑↑	↑	↑	↑	↑			
Traffic Volume (veh/h)	0	195	619	0	347	61	162	0	105	0	0	0
Future Volume (veh/h)	0	195	619	0	347	61	162	0	105	0	0	0
Number	5	2	12	1	6	16	3	8	18			
Initial Q (Qb), veh	0	0	0	0	0	0	0	0	0			
Ped-Bike Adj(A_pbT)	1.00		1.00	1.00		1.00	1.00		1.00			
Parking Bus, Adj	1.00	1.00	1.00	1.00	1.00	1.00	1.00	1.00	1.00			
Adj Sat Flow, veh/h/ln	0	1863	1863	0	1863	1863	1863	1863	1863			
Adj Flow Rate, veh/h	0	203	645	0	361	64	203	0	73			
Adj No. of Lanes	0	2	1	0	3	1	2	0	1			
Peak Hour Factor	0.96	0.96	0.96	0.96	0.96	0.96	0.96	0.96	0.96			
Percent Heavy Veh, %	0	2	2	0	2	2	2	2	2			
Cap, veh/h	0	1619	955	0	2327	724	517	0	231			
Arrive On Green	0.00	0.46	0.46	0.00	0.46	0.46	0.15	0.00	0.15			
Sat Flow, veh/h	0	3632	1583	0	5253	1583	3548	0	1583			
Grp Volume(v), veh/h	0	203	645	0	361	64	203	0	73			
Grp Sat Flow(s),veh/h/ln	0	1770	1583	0	1695	1583	1774	0	1583			
Q Serve(g_s), s	0.0	1.1	9.3	0.0	1.4	0.8	1.8	0.0	1.4			
Cycle Q Clear(g_c), s	0.0	1.1	9.3	0.0	1.4	0.8	1.8	0.0	1.4			
Prop In Lane	0.00		1.00	0.00		1.00	1.00		1.00			
Lane Grp Cap(c), veh/h	0	1619	955	0	2327	724	517	0	231			
V/C Ratio(X)	0.00	0.13	0.68	0.00	0.16	0.09	0.39	0.00	0.32			
Avail Cap(c_a), veh/h	0	5264	2586	0	5339	1662	4553	0	2032			
HCM Platoon Ratio	1.00	1.00	1.00	1.00	1.00	1.00	1.00	1.00	1.00			
Upstream Filter(I)	0.00	1.00	1.00	0.00	1.00	1.00	1.00	0.00	1.00			
Uniform Delay (d), s/veh	0.0	5.4	4.6	0.0	5.4	5.3	13.3	0.0	13.1			
Incr Delay (d2), s/veh	0.0	0.0	0.8	0.0	0.0	0.1	0.5	0.0	0.8			
Initial Q Delay(d3),s/veh	0.0	0.0	0.0	0.0	0.0	0.0	0.0	0.0	0.0			
%ile BackOfQ(50%),veh/ln	0.0	0.5	5.6	0.0	0.7	0.3	0.9	0.0	0.7			
LnGrp Delay(d),s/veh	0.0	5.4	5.4	0.0	5.5	5.3	13.8	0.0	13.9			
LnGrp LOS		A	A		A	A	B		B			
Approach Vol, veh/h		848			425			276				
Approach Delay, s/veh		5.4			5.4			13.8				
Approach LOS		A			A			B				
Timer	1	2	3	4	5	6	7	8				
Assigned Phs		2				6		8				
Phs Duration (G+Y+Rc), s		23.2				23.2		11.1				
Change Period (Y+Rc), s		7.5				7.5		6.1				
Max Green Setting (Gmax), s		51.0				36.0		44.0				
Max Q Clear Time (g_c+I1), s		11.3				3.4		3.8				
Green Ext Time (p_c), s		4.3				2.8		1.0				
Intersection Summary												
HCM 2010 Ctrl Delay			6.9									
HCM 2010 LOS			A									
Notes												

HCM 2010 Signalized Intersection Summary
 1: Highway 76 & Olive Hill Road/Camino Del Rey

Existing PM Peak Hour
 07/10/2019

												
Movement	EBL	EBT	EBR	WBL	WBT	WBR	NBL	NBT	NBR	SBL	SBT	SBR
Lane Configurations	 							  		 	  	
Traffic Volume (veh/h)	112	60	123	135	118	297	139	2263	139	217	1322	49
Future Volume (veh/h)	112	60	123	135	118	297	139	2263	139	217	1322	49
Number	7	4	14	3	8	18	5	2	12	1	6	16
Initial Q (Qb), veh	0	0	0	0	0	0	0	0	0	0	0	0
Ped-Bike Adj(A_pbT)	1.00		1.00	1.00		1.00	1.00		1.00	1.00		1.00
Parking Bus, Adj	1.00	1.00	1.00	1.00	1.00	1.00	1.00	1.00	1.00	1.00	1.00	1.00
Adj Sat Flow, veh/h/ln	1863	1863	1863	1863	1863	1863	1863	1863	1863	1863	1863	1863
Adj Flow Rate, veh/h	114	61	126	138	120	303	142	2309	142	221	1349	50
Adj No. of Lanes	2	1	1	1	1	1	1	3	1	2	3	1
Peak Hour Factor	0.98	0.98	0.98	0.98	0.98	0.98	0.98	0.98	0.98	0.98	0.98	0.98
Percent Heavy Veh, %	2	2	2	2	2	2	2	2	2	2	2	2
Cap, veh/h	320	173	147	371	389	331	163	2457	765	266	2382	742
Arrive On Green	0.09	0.09	0.09	0.21	0.21	0.21	0.09	0.48	0.48	0.08	0.47	0.47
Sat Flow, veh/h	3442	1863	1583	1774	1863	1583	1774	5085	1583	3442	5085	1583
Grp Volume(v), veh/h	114	61	126	138	120	303	142	2309	142	221	1349	50
Grp Sat Flow(s),veh/h/ln	1721	1863	1583	1774	1863	1583	1774	1695	1583	1721	1695	1583
Q Serve(g_s), s	5.7	5.7	14.5	12.3	10.1	34.6	14.6	79.4	9.4	11.7	35.4	3.2
Cycle Q Clear(g_c), s	5.7	5.7	14.5	12.3	10.1	34.6	14.6	79.4	9.4	11.7	35.4	3.2
Prop In Lane	1.00		1.00	1.00		1.00	1.00		1.00	1.00		1.00
Lane Grp Cap(c), veh/h	320	173	147	371	389	331	163	2457	765	266	2382	742
V/C Ratio(X)	0.36	0.35	0.86	0.37	0.31	0.92	0.87	0.94	0.19	0.83	0.57	0.07
Avail Cap(c_a), veh/h	447	242	206	509	535	454	288	2478	772	503	2478	772
HCM Platoon Ratio	1.00	1.00	1.00	1.00	1.00	1.00	1.00	1.00	1.00	1.00	1.00	1.00
Upstream Filter(I)	1.00	1.00	1.00	1.00	1.00	1.00	1.00	1.00	1.00	1.00	1.00	1.00
Uniform Delay (d), s/veh	78.6	78.6	82.6	62.6	61.7	71.4	82.8	45.2	27.1	84.0	35.5	26.9
Incr Delay (d2), s/veh	0.7	1.2	21.5	0.6	0.4	18.8	13.1	7.9	0.1	6.6	0.3	0.0
Initial Q Delay(d3),s/veh	0.0	0.0	0.0	0.0	0.0	0.0	0.0	0.0	0.0	0.0	0.0	0.0
%ile BackOfQ(50%),veh/ln	2.8	3.0	7.2	6.1	5.2	16.9	7.8	39.0	4.1	5.8	16.7	1.4
LnGrp Delay(d),s/veh	79.3	79.8	104.1	63.3	62.2	90.2	95.8	53.1	27.2	90.6	35.8	27.0
LnGrp LOS	E	E	F	E	E	F	F	D	C	F	D	C
Approach Vol, veh/h		301			561			2593			1620	
Approach Delay, s/veh		89.7			77.6			54.0			43.0	
Approach LOS		F			E			D			D	
Timer	1	2	3	4	5	6	7	8				
Assigned Phs	1	2		4	5	6		8				
Phs Duration (G+Y+Rc), s	20.0	96.7		23.3	22.7	94.0		44.7				
Change Period (Y+Rc), s	* 5.7	7.5		6.1	* 5.7	7.5		6.1				
Max Green Setting (Gmax), s	* 27	90.0		24.0	* 30	90.0		53.0				
Max Q Clear Time (g_c+I1), s	13.7	81.4		16.5	16.6	37.4		36.6				
Green Ext Time (p_c), s	0.6	7.8		0.7	0.3	14.7		2.0				
Intersection Summary												
HCM 2010 Ctrl Delay			55.2									
HCM 2010 LOS			E									
Notes												

Intersection						
Int Delay, s/veh	0					
Movement	EBL	EBR	NBL	NBT	SBT	SBR
Lane Configurations	↘↙		↘	↑	↑	↘
Traffic Vol, veh/h	320	79	92	62	53	478
Future Vol, veh/h	320	79	92	62	53	478
Conflicting Peds, #/hr	0	0	0	0	0	0
Sign Control	Free	Free	Stop	Stop	Free	Free
RT Channelized	-	Free	-	None	-	Free
Storage Length	0	-	150	-	-	150
Veh in Median Storage, #	-	-	-	0	0	-
Grade, %	0	-	-	0	0	-
Peak Hour Factor	97	97	97	97	97	97
Heavy Vehicles, %	2	2	2	2	2	2
Mvmt Flow	330	81	95	64	55	493

Major/Minor	Minor2	Major2		
Conflicting Flow All	55	55	-	0
Stage 1	55	55	-	-
Stage 2	0	0	-	-
Critical Hdwy	6.42	6.52	-	-
Critical Hdwy Stg 1	5.42	5.52	-	-
Critical Hdwy Stg 2	-	-	-	-
Follow-up Hdwy	3.518	4.018	-	-
Pot Cap-1 Maneuver	953	836	-	0
Stage 1	968	849	-	0
Stage 2	-	-	-	0
Platoon blocked, %			-	
Mov Cap-1 Maneuver	953	0	-	-
Mov Cap-2 Maneuver	953	0	-	-
Stage 1	968	0	-	-
Stage 2	-	0	-	-

Approach	NB	SB
HCM Control Delay, s		0
HCM LOS	-	

Minor Lane/Major Mvmt	NBLn1	NBLn2	SBT
Capacity (veh/h)	953	-	-
HCM Lane V/C Ratio	0.1	-	-
HCM Control Delay (s)	9.2	-	-
HCM Lane LOS	A	-	-
HCM 95th %tile Q(veh)	0.3	-	-

Intersection						
Int Delay, s/veh	2.5					
Movement	EBL	EBT	WBT	WBR	SBL	SBR
Lane Configurations		↶	↷		↶	↷
Traffic Vol, veh/h	107	264	451	10	1	106
Future Vol, veh/h	107	264	451	10	1	106
Conflicting Peds, #/hr	0	0	0	0	0	0
Sign Control	Free	Free	Free	Free	Stop	Stop
RT Channelized	-	None	-	None	-	Stop
Storage Length	-	-	-	-	0	100
Veh in Median Storage, #	-	0	0	-	0	-
Grade, %	-	0	0	-	0	-
Peak Hour Factor	91	91	91	91	91	91
Heavy Vehicles, %	2	2	2	2	2	2
Mvmt Flow	118	290	496	11	1	116

























Major/Minor	Major1	Major2	Minor2		
Conflicting Flow All	507	0	-	0	1028 502
Stage 1	-	-	-	-	502 -
Stage 2	-	-	-	-	526 -
Critical Hdwy	4.12	-	-	-	6.42 6.22
Critical Hdwy Stg 1	-	-	-	-	5.42 -
Critical Hdwy Stg 2	-	-	-	-	5.42 -
Follow-up Hdwy	2.218	-	-	-	3.518 3.318
Pot Cap-1 Maneuver	1058	-	-	-	259 569
Stage 1	-	-	-	-	608 -
Stage 2	-	-	-	-	593 -
Platoon blocked, %		-	-	-	
Mov Cap-1 Maneuver	1058	-	-	-	225 569
Mov Cap-2 Maneuver	-	-	-	-	225 -
Stage 1	-	-	-	-	527 -
Stage 2	-	-	-	-	593 -

Approach	EB	WB	SB
HCM Control Delay, s	2.5	0	13
HCM LOS			B

Minor Lane/Major Mvmt	EBL	EBT	WBT	WBR	SBLn1	SBLn2
Capacity (veh/h)	1058	-	-	-	225	569
HCM Lane V/C Ratio	0.111	-	-	-	0.005	0.205
HCM Control Delay (s)	8.8	0	-	-	21.1	12.9
HCM Lane LOS	A	A	-	-	C	B
HCM 95th %tile Q(veh)	0.4	-	-	-	0	0.8

HCM 2010 Signalized Intersection Summary
4: Old Highway 395 & Highway 76

Existing PM Peak Hour
07/10/2019

												
Movement	EBL	EBT	EBR	WBL	WBT	WBR	NBL	NBT	NBR	SBL	SBT	SBR
Lane Configurations												
Traffic Volume (veh/h)	155	1077	113	38	868	229	113	160	50	191	71	62
Future Volume (veh/h)	155	1077	113	38	868	229	113	160	50	191	71	62
Number	5	2	12	1	6	16	3	8	18	7	4	14
Initial Q (Qb), veh	0	0	0	0	0	0	0	0	0	0	0	0
Ped-Bike Adj(A_pbT)	1.00		1.00	1.00		1.00	1.00		1.00	1.00		1.00
Parking Bus, Adj	1.00	1.00	1.00	1.00	1.00	1.00	1.00	1.00	1.00	1.00	1.00	1.00
Adj Sat Flow, veh/h/ln	1863	1863	1863	1863	1863	1863	1863	1863	1863	1863	1863	1900
Adj Flow Rate, veh/h	165	1146	17	40	923	0	120	170	-23	203	76	61
Adj No. of Lanes	1	3	1	1	2	1	1	1	1	2	1	0
Peak Hour Factor	0.94	0.94	0.94	0.94	0.94	0.94	0.94	0.94	0.94	0.94	0.94	0.94
Percent Heavy Veh, %	2	2	2	2	2	2	2	2	2	2	2	2
Cap, veh/h	260	1894	590	183	1164	724	195	256	381	442	165	133
Arrive On Green	0.15	0.37	0.37	0.10	0.33	0.00	0.11	0.14	0.00	0.13	0.17	0.17
Sat Flow, veh/h	1774	5085	1583	1774	3539	1583	1774	1863	1583	3442	958	769
Grp Volume(v), veh/h	165	1146	17	40	923	0	120	170	-23	203	0	137
Grp Sat Flow(s),veh/h/ln	1774	1695	1583	1774	1770	1583	1774	1863	1583	1721	0	1727
Q Serve(g_s), s	9.5	19.9	0.7	2.3	25.8	0.0	7.0	9.4	0.0	6.0	0.0	7.8
Cycle Q Clear(g_c), s	9.5	19.9	0.7	2.3	25.8	0.0	7.0	9.4	0.0	6.0	0.0	7.8
Prop In Lane	1.00		1.00	1.00		1.00	1.00		1.00	1.00		0.45
Lane Grp Cap(c), veh/h	260	1894	590	183	1164	724	195	256	381	442	0	298
V/C Ratio(X)	0.63	0.61	0.03	0.22	0.79	0.00	0.61	0.66	-0.06	0.46	0.00	0.46
Avail Cap(c_a), veh/h	439	2798	871	504	2109	1147	488	564	642	1515	0	1013
HCM Platoon Ratio	1.00	1.00	1.00	1.00	1.00	1.00	1.00	1.00	1.00	1.00	1.00	1.00
Upstream Filter(I)	1.00	1.00	1.00	1.00	1.00	0.00	1.00	1.00	0.00	1.00	0.00	1.00
Uniform Delay (d), s/veh	43.8	27.7	21.7	44.9	33.2	0.0	46.3	44.6	0.0	44.0	0.0	40.6
Incr Delay (d2), s/veh	2.5	0.3	0.0	0.6	1.3	0.0	3.1	2.9	0.0	0.7	0.0	1.1
Initial Q Delay(d3),s/veh	0.0	0.0	0.0	0.0	0.0	0.0	0.0	0.0	0.0	0.0	0.0	0.0
%ile BackOfQ(50%),veh/ln	4.9	9.4	0.3	1.1	12.8	0.0	3.6	5.1	0.0	2.9	0.0	3.8
LnGrp Delay(d),s/veh	46.3	28.0	21.7	45.5	34.5	0.0	49.4	47.6	0.0	44.8	0.0	41.7
LnGrp LOS	D	C	C	D	C		D	D		D		D
Approach Vol, veh/h		1328			963			267			340	
Approach Delay, s/veh		30.2			35.0			52.5			43.5	
Approach LOS		C			C			D			D	
Timer	1	2	3	4	5	6	7	8				
Assigned Phs	1	2	3	4	5	6	7	8				
Phs Duration (G+Y+Rc), s	16.9	48.1	17.7	26.3	21.7	43.4	21.5	22.5				
Change Period (Y+Rc), s	* 5.7	7.5	* 5.7	7.5	* 5.7	7.5	7.5	* 7.5				
Max Green Setting (Gmax), s	* 31	60.0	* 30	64.0	* 27	65.0	48.0	* 33				
Max Q Clear Time (g_c+I1), s	4.3	21.9	9.0	9.8	11.5	27.8	8.0	11.4				
Green Ext Time (p_c), s	0.1	10.7	0.3	0.9	0.4	8.0	0.7	0.9				
Intersection Summary												
HCM 2010 Ctrl Delay			35.4									
HCM 2010 LOS			D									
Notes												

Intersection						
Int Delay, s/veh	3					
Movement	WBL	WBR	NBT	NBR	SBL	SBT
Lane Configurations						
Traffic Vol, veh/h	30	61	231	106	106	116
Future Vol, veh/h	30	61	231	106	106	116
Conflicting Peds, #/hr	0	0	0	0	0	0
Sign Control	Stop	Stop	Free	Free	Free	Free
RT Channelized	-	None	-	None	-	None
Storage Length	0	385	-	-	-	-
Veh in Median Storage, #	0	-	0	-	-	0
Grade, %	0	-	0	-	-	0
Peak Hour Factor	95	95	95	95	95	95
Heavy Vehicles, %	2	2	2	2	2	2
Mvmt Flow	32	64	243	112	112	122

Major/Minor	Minor1	Major1	Major2			
Conflicting Flow All	645	299	0	0	355	0
Stage 1	299	-	-	-	-	-
Stage 2	346	-	-	-	-	-
Critical Hdwy	6.42	6.22	-	-	4.12	-
Critical Hdwy Stg 1	5.42	-	-	-	-	-
Critical Hdwy Stg 2	5.42	-	-	-	-	-
Follow-up Hdwy	3.518	3.318	-	-	2.218	-
Pot Cap-1 Maneuver	437	741	-	-	1204	-
Stage 1	752	-	-	-	-	-
Stage 2	716	-	-	-	-	-
Platoon blocked, %			-	-	-	-
Mov Cap-1 Maneuver	393	741	-	-	1204	-
Mov Cap-2 Maneuver	393	-	-	-	-	-
Stage 1	677	-	-	-	-	-
Stage 2	716	-	-	-	-	-

Approach	WB	NB	SB
HCM Control Delay, s	11.8	0	4
HCM LOS	B		

Minor Lane/Major Mvmt	NBT	NBRWBLn1	WBLn2	SBL	SBT	
Capacity (veh/h)	-	-	393	741	1204	-
HCM Lane V/C Ratio	-	-	0.08	0.087	0.093	-
HCM Control Delay (s)	-	-	15	10.3	8.3	0
HCM Lane LOS	-	-	C	B	A	A
HCM 95th %tile Q(veh)	-	-	0.3	0.3	0.3	-

Intersection												
Int Delay, s/veh	3.7											
Movement	EBL	EBT	EBR	WBL	WBT	WBR	NBL	NBT	NBR	SBL	SBT	SBR
Lane Configurations		↕	↗		↕	↗	↗	↗		↗	↕↗	
Traffic Vol, veh/h	36	10	32	14	6	29	56	269	34	22	101	24
Future Vol, veh/h	36	10	32	14	6	29	56	269	34	22	101	24
Conflicting Peds, #/hr	0	0	0	0	0	0	0	0	0	0	0	0
Sign Control	Stop	Stop	Stop	Stop	Stop	Stop	Free	Free	Free	Free	Free	Free
RT Channelized	-	-	Stop	-	-	Stop	-	-	None	-	-	None
Storage Length	-	-	25	-	-	50	210	-	-	200	-	530
Veh in Median Storage, #	-	0	-	-	0	-	-	0	-	-	0	-
Grade, %	-	0	-	-	0	-	-	0	-	-	0	-
Peak Hour Factor	86	86	86	86	86	86	86	86	86	86	86	86
Heavy Vehicles, %	2	2	2	2	2	2	2	2	2	2	2	2
Mvmt Flow	42	12	37	16	7	34	65	313	40	26	117	28

Major/Minor	Minor2		Minor1		Major1			Major2				
Conflicting Flow All	650	666	73	580	660	333	145	0	0	353	0	0
Stage 1	183	183	-	463	463	-	-	-	-	-	-	-
Stage 2	467	483	-	117	197	-	-	-	-	-	-	-
Critical Hdwy	7.33	6.53	6.93	7.33	6.53	6.23	4.13	-	-	4.13	-	-
Critical Hdwy Stg 1	6.53	5.53	-	6.13	5.53	-	-	-	-	-	-	-
Critical Hdwy Stg 2	6.13	5.53	-	6.53	5.53	-	-	-	-	-	-	-
Follow-up Hdwy	3.519	4.019	3.319	3.519	4.019	3.319	2.219	-	-	2.219	-	-
Pot Cap-1 Maneuver	368	379	975	411	382	708	1436	-	-	1204	-	-
Stage 1	802	748	-	578	563	-	-	-	-	-	-	-
Stage 2	575	552	-	876	737	-	-	-	-	-	-	-
Platoon blocked, %								-	-	-	-	-
Mov Cap-1 Maneuver	328	354	975	366	357	708	1436	-	-	1204	-	-
Mov Cap-2 Maneuver	328	354	-	366	357	-	-	-	-	-	-	-
Stage 1	766	732	-	552	538	-	-	-	-	-	-	-
Stage 2	516	527	-	811	721	-	-	-	-	-	-	-

Approach	EB		WB		NB		SB	
HCM Control Delay, s	14.2		12.5		1.2		1.2	
HCM LOS	B		B					

Minor Lane/Major Mvmt	NBL	NBT	NBR	EBLn1	EBLn2	WBLn1	WBLn2	SBL	SBT	SBR
Capacity (veh/h)	1436	-	-	333	975	363	708	1204	-	-
HCM Lane V/C Ratio	0.045	-	-	0.161	0.038	0.064	0.048	0.021	-	-
HCM Control Delay (s)	7.6	-	-	17.9	8.8	15.6	10.3	8.1	-	-
HCM Lane LOS	A	-	-	C	A	C	B	A	-	-
HCM 95th %tile Q(veh)	0.1	-	-	0.6	0.1	0.2	0.1	0.1	-	-

Intersection												
Int Delay, s/veh	2.3											
Movement	EBL	EBT	EBR	WBL	WBT	WBR	NBL	NBT	NBR	SBL	SBT	SBR
Lane Configurations		↑	↗	↘	↑						↑	↗
Traffic Vol, veh/h	0	57	120	5	346	0	0	0	0	70	6	12
Future Vol, veh/h	0	57	120	5	346	0	0	0	0	70	6	12
Conflicting Peds, #/hr	0	0	0	0	0	0	0	0	0	0	0	0
Sign Control	Free	Free	Free	Free	Free	Free	Stop	Stop	Stop	Stop	Stop	Stop
RT Channelized	-	-	Free	-	-	None	-	-	None	-	-	Yield
Storage Length	-	-	390	55	-	-	-	-	-	-	-	32
Veh in Median Storage, #	-	0	-	-	0	-	-	-	-	-	0	-
Grade, %	-	0	-	-	0	-	-	0	-	-	0	-
Peak Hour Factor	88	88	88	88	88	88	88	88	88	88	88	88
Heavy Vehicles, %	2	2	2	2	2	2	2	2	2	2	2	2
Mvmt Flow	0	65	136	6	393	0	0	0	0	80	7	14

Major/Minor	Major1			Major2			Minor2			
Conflicting Flow All	-	0	-	65	0	0	-	470	470	393
Stage 1	-	-	-	-	-	-	-	405	405	-
Stage 2	-	-	-	-	-	-	-	65	65	-
Critical Hdwy	-	-	-	4.12	-	-	-	6.42	6.52	6.22
Critical Hdwy Stg 1	-	-	-	-	-	-	-	5.42	5.52	-
Critical Hdwy Stg 2	-	-	-	-	-	-	-	5.42	5.52	-
Follow-up Hdwy	-	-	-	2.218	-	-	-	3.518	4.018	3.318
Pot Cap-1 Maneuver	0	-	0	1537	-	0	-	552	492	656
Stage 1	0	-	0	-	-	0	-	673	598	-
Stage 2	0	-	0	-	-	0	-	958	841	-
Platoon blocked, %	-	-	-	-	-	-	-	-	-	-
Mov Cap-1 Maneuver	-	-	-	1537	-	-	-	550	0	656
Mov Cap-2 Maneuver	-	-	-	-	-	-	-	550	0	-
Stage 1	-	-	-	-	-	-	-	670	0	-
Stage 2	-	-	-	-	-	-	-	958	0	-

Approach	EB	WB	SB
HCM Control Delay, s	0	0.1	12.5
HCM LOS			B

Minor Lane/Major Mvmt	EBT	WBL	WBT	SBLn1	SBLn2
Capacity (veh/h)	-	1537	-	550	656
HCM Lane V/C Ratio	-	0.004	-	0.157	0.021
HCM Control Delay (s)	-	7.4	-	12.8	10.6
HCM Lane LOS	-	A	-	B	B
HCM 95th %tile Q(veh)	-	0	-	0.6	0.1

Intersection												
Int Delay, s/veh	5.7											
Movement	EBL	EBT	EBR	WBL	WBT	WBR	NBL	NBT	NBR	SBL	SBT	SBR
Lane Configurations		↑	↗		↑	↗	↘		↗			
Traffic Vol, veh/h	0	122	9	0	148	39	200	0	21	0	0	0
Future Vol, veh/h	0	122	9	0	148	39	200	0	21	0	0	0
Conflicting Peds, #/hr	0	0	0	0	0	0	0	0	0	0	0	0
Sign Control	Free	Free	Free	Free	Free	Free	Stop	Stop	Stop	Stop	Stop	Stop
RT Channelized	-	-	Free	-	-	Free	-	-	Stop	-	-	None
Storage Length	-	-	200	-	-	100	0	-	150	-	-	-
Veh in Median Storage, #	-	0	-	-	0	-	-	0	-	-	16965	-
Grade, %	-	0	-	-	0	-	-	0	-	-	0	-
Peak Hour Factor	86	86	86	86	86	86	86	86	86	86	86	86
Heavy Vehicles, %	2	2	2	2	2	2	2	2	2	2	2	2
Mvmt Flow	0	142	10	0	172	45	233	0	24	0	0	0

Major/Minor	Major1		Major2		Minor1				
Conflicting Flow All	-	0	-	-	0	314	-	142	
Stage 1	-	-	-	-	-	142	-	-	
Stage 2	-	-	-	-	-	172	-	-	
Critical Hdwy	-	-	-	-	-	6.42	-	6.22	
Critical Hdwy Stg 1	-	-	-	-	-	5.42	-	-	
Critical Hdwy Stg 2	-	-	-	-	-	5.42	-	-	
Follow-up Hdwy	-	-	-	-	-	3.518	-	3.318	
Pot Cap-1 Maneuver	0	-	0	0	-	0	679	0	906
Stage 1	0	-	0	0	-	0	885	0	-
Stage 2	0	-	0	0	-	0	858	0	-
Platoon blocked, %	-	-	-	-	-	-	-	-	-
Mov Cap-1 Maneuver	-	-	-	-	-	-	679	0	906
Mov Cap-2 Maneuver	-	-	-	-	-	-	679	0	-
Stage 1	-	-	-	-	-	-	885	0	-
Stage 2	-	-	-	-	-	-	858	0	-

Approach	EB	WB	NB
HCM Control Delay, s	0	0	12.6
HCM LOS			B

Minor Lane/Major Mvmt	NBLn1	NBLn2	EBT	WBT
Capacity (veh/h)	679	906	-	-
HCM Lane V/C Ratio	0.343	0.027	-	-
HCM Control Delay (s)	13	9.1	-	-
HCM Lane LOS	B	A	-	-
HCM 95th %tile Q(veh)	1.5	0.1	-	-

Intersection						
Int Delay, s/veh	6.4					
Movement	EBL	EBR	NBL	NBT	SBT	SBR
Lane Configurations	Y		Y	↑	↑	Y
Traffic Vol, veh/h	20	155	398	223	111	18
Future Vol, veh/h	20	155	398	223	111	18
Conflicting Peds, #/hr	0	0	0	0	0	0
Sign Control	Stop	Stop	Free	Free	Free	Free
RT Channelized	-	None	-	None	-	None
Storage Length	0	-	110	-	-	50
Veh in Median Storage, #	0	-	-	0	0	-
Grade, %	0	-	-	0	0	-
Peak Hour Factor	94	94	94	94	94	94
Heavy Vehicles, %	2	2	2	2	2	2
Mvmt Flow	21	165	423	237	118	19

Major/Minor	Minor2	Major1	Major2			
Conflicting Flow All	1201	118	137	0	-	0
Stage 1	118	-	-	-	-	-
Stage 2	1083	-	-	-	-	-
Critical Hdwy	6.42	6.22	4.12	-	-	-
Critical Hdwy Stg 1	5.42	-	-	-	-	-
Critical Hdwy Stg 2	5.42	-	-	-	-	-
Follow-up Hdwy	3.518	3.318	2.218	-	-	-
Pot Cap-1 Maneuver	204	934	1447	-	-	-
Stage 1	907	-	-	-	-	-
Stage 2	325	-	-	-	-	-
Platoon blocked, %				-	-	-
Mov Cap-1 Maneuver	144	934	1447	-	-	-
Mov Cap-2 Maneuver	144	-	-	-	-	-
Stage 1	642	-	-	-	-	-
Stage 2	325	-	-	-	-	-

Approach	EB	NB	SB
HCM Control Delay, s	14.3	5.5	0
HCM LOS	B		

Minor Lane/Major Mvmt	NBL	NBT	EBLn1	SBT	SBR
Capacity (veh/h)	1447	-	574	-	-
HCM Lane V/C Ratio	0.293	-	0.324	-	-
HCM Control Delay (s)	8.5	-	14.3	-	-
HCM Lane LOS	A	-	B	-	-
HCM 95th %tile Q(veh)	1.2	-	1.4	-	-

Intersection						
Int Delay, s/veh	8.4					
Movement	WBL	WBR	NBT	NBR	SBL	SBT
Lane Configurations	Y		T		T	T
Traffic Vol, veh/h	139	37	594	206	41	256
Future Vol, veh/h	139	37	594	206	41	256
Conflicting Peds, #/hr	0	0	0	0	0	0
Sign Control	Stop	Stop	Free	Free	Free	Free
RT Channelized	-	None	-	None	-	None
Storage Length	0	-	-	-	165	-
Veh in Median Storage, #	0	-	0	-	-	0
Grade, %	0	-	0	-	-	0
Peak Hour Factor	93	93	93	93	93	93
Heavy Vehicles, %	2	2	2	2	2	2
Mvmt Flow	149	40	639	222	44	275













Major/Minor	Minor1	Major1	Major2		
Conflicting Flow All	1113	750	0	0	861
Stage 1	750	-	-	-	-
Stage 2	363	-	-	-	-
Critical Hdwy	6.42	6.22	-	-	4.12
Critical Hdwy Stg 1	5.42	-	-	-	-
Critical Hdwy Stg 2	5.42	-	-	-	-
Follow-up Hdwy	3.518	3.318	-	-	2.218
Pot Cap-1 Maneuver	231	411	-	-	781
Stage 1	467	-	-	-	-
Stage 2	704	-	-	-	-
Platoon blocked, %			-	-	-
Mov Cap-1 Maneuver	218	411	-	-	781
Mov Cap-2 Maneuver	218	-	-	-	-
Stage 1	441	-	-	-	-
Stage 2	704	-	-	-	-

Approach	WB	NB	SB
HCM Control Delay, s	58.2	0	1.4
HCM LOS	F		

Minor Lane/Major Mvmt	NBT	NBRWBLn1	SBL	SBT
Capacity (veh/h)	-	-	242	781
HCM Lane V/C Ratio	-	-	0.782	0.056
HCM Control Delay (s)	-	-	58.2	9.9
HCM Lane LOS	-	-	F	A
HCM 95th %tile Q(veh)	-	-	5.7	0.2

HCM 2010 Signalized Intersection Summary
 11: Old Highway 395 & Gopher Canyon Road

Existing PM Peak Hour
 07/10/2019

								
Movement	EBL	EBR	NBL	NBT	SBT	SBR		
Lane Configurations								
Traffic Volume (veh/h)	503	239	254	309	169	228		
Future Volume (veh/h)	503	239	254	309	169	228		
Number	7	14	5	2	6	16		
Initial Q (Qb), veh	0	0	0	0	0	0		
Ped-Bike Adj(A_pbT)	1.00	1.00	1.00			1.00		
Parking Bus, Adj	1.00	1.00	1.00	1.00	1.00	1.00		
Adj Sat Flow, veh/h/ln	1863	1863	1863	1863	1863	1863		
Adj Flow Rate, veh/h	524	249	265	322	176	238		
Adj No. of Lanes	1	1	1	1	1	1		
Peak Hour Factor	0.96	0.96	0.96	0.96	0.96	0.96		
Percent Heavy Veh, %	2	2	2	2	2	2		
Cap, veh/h	542	781	333	944	419	356		
Arrive On Green	0.31	0.31	0.19	0.51	0.23	0.23		
Sat Flow, veh/h	1774	1583	1774	1863	1863	1583		
Grp Volume(v), veh/h	524	249	265	322	176	238		
Grp Sat Flow(s),veh/h/ln	1774	1583	1774	1863	1863	1583		
Q Serve(g_s), s	12.4	4.0	6.1	4.4	3.4	5.8		
Cycle Q Clear(g_c), s	12.4	4.0	6.1	4.4	3.4	5.8		
Prop In Lane	1.00	1.00	1.00			1.00		
Lane Grp Cap(c), veh/h	542	781	333	944	419	356		
V/C Ratio(X)	0.97	0.32	0.79	0.34	0.42	0.67		
Avail Cap(c_a), veh/h	542	781	500	1925	1225	1041		
HCM Platoon Ratio	1.00	1.00	1.00	1.00	1.00	1.00		
Upstream Filter(I)	1.00	1.00	1.00	1.00	1.00	1.00		
Uniform Delay (d), s/veh	14.6	6.5	16.5	6.3	14.1	15.0		
Incr Delay (d2), s/veh	30.5	0.2	5.2	0.2	0.7	2.2		
Initial Q Delay(d3),s/veh	0.0	0.0	0.0	0.0	0.0	0.0		
%ile BackOfQ(50%),veh/ln	10.6	4.4	3.4	2.3	1.8	2.7		
LnGrp Delay(d),s/veh	45.1	6.7	21.7	6.5	14.8	17.2		
LnGrp LOS	D	A	C	A	B	B		
Approach Vol, veh/h	773			587	414			
Approach Delay, s/veh	32.7			13.4	16.2			
Approach LOS	C			B	B			
Timer	1	2	3	4	5	6	7	8
Assigned Phs	2		4		5	6		
Phs Duration (G+Y+Rc), s	25.6		17.0		12.0	13.6		
Change Period (Y+Rc), s	4.0		4.0		4.0	4.0		
Max Green Setting (Gmax), s	44.0		13.0		12.0	28.0		
Max Q Clear Time (g_c+I1), s	6.4		14.4		8.1	7.8		
Green Ext Time (p_c), s	2.1		0.0		0.3	1.7		
Intersection Summary								
HCM 2010 Ctrl Delay			22.5					
HCM 2010 LOS			C					

Intersection												
Int Delay, s/veh	3.9											
Movement	EBL	EBT	EBR	WBL	WBT	WBR	NBL	NBT	NBR	SBL	SBT	SBR
Lane Configurations		↕			↕			↕			↕	
Traffic Vol, veh/h	8	1	5	4	0	4	16	17	4	7	20	8
Future Vol, veh/h	8	1	5	4	0	4	16	17	4	7	20	8
Conflicting Peds, #/hr	0	0	0	0	0	0	0	0	0	0	0	0
Sign Control	Stop	Stop	Stop	Stop	Stop	Stop	Free	Free	Free	Free	Free	Free
RT Channelized	-	-	None	-	-	None	-	-	None	-	-	None
Storage Length	-	-	-	-	-	-	-	-	-	-	-	-
Veh in Median Storage, #	-	0	-	-	0	-	-	0	-	-	0	-
Grade, %	-	0	-	-	0	-	-	0	-	-	0	-
Peak Hour Factor	78	78	78	78	78	78	78	78	78	78	78	78
Heavy Vehicles, %	2	2	2	2	2	2	2	2	2	2	2	2
Mvmt Flow	10	1	6	5	0	5	21	22	5	9	26	10

Major/Minor	Minor2		Minor1		Major1		Major2					
Conflicting Flow All	118	118	31	120	121	25	36	0	0	27	0	0
Stage 1	49	49	-	67	67	-	-	-	-	-	-	-
Stage 2	69	69	-	53	54	-	-	-	-	-	-	-
Critical Hdwy	7.12	6.52	6.22	7.12	6.52	6.22	4.12	-	-	4.12	-	-
Critical Hdwy Stg 1	6.12	5.52	-	6.12	5.52	-	-	-	-	-	-	-
Critical Hdwy Stg 2	6.12	5.52	-	6.12	5.52	-	-	-	-	-	-	-
Follow-up Hdwy	3.518	4.018	3.318	3.518	4.018	3.318	2.218	-	-	2.218	-	-
Pot Cap-1 Maneuver	858	772	1043	855	769	1051	1575	-	-	1587	-	-
Stage 1	964	854	-	943	839	-	-	-	-	-	-	-
Stage 2	941	837	-	960	850	-	-	-	-	-	-	-
Platoon blocked, %								-	-	-	-	-
Mov Cap-1 Maneuver	841	757	1043	835	754	1051	1575	-	-	1587	-	-
Mov Cap-2 Maneuver	841	757	-	835	754	-	-	-	-	-	-	-
Stage 1	951	849	-	930	827	-	-	-	-	-	-	-
Stage 2	923	825	-	947	845	-	-	-	-	-	-	-

Approach	EB		WB		NB		SB	
HCM Control Delay, s	9.1		8.9		3.2		1.5	
HCM LOS	A		A					

Minor Lane/Major Mvmt	NBL	NBT	NBR	EBLn1WBLn1	SBL	SBT	SBR
Capacity (veh/h)	1575	-	-	896	931	1587	-
HCM Lane V/C Ratio	0.013	-	-	0.02	0.011	0.006	-
HCM Control Delay (s)	7.3	0	-	9.1	8.9	7.3	0
HCM Lane LOS	A	A	-	A	A	A	A
HCM 95th %tile Q(veh)	0	-	-	0.1	0	0	-

Intersection						
Int Delay, s/veh	2.9					
Movement	WBL	WBR	NBT	NBR	SBL	SBT
Lane Configurations	W		T			T
Traffic Vol, veh/h	28	11	28	68	25	31
Future Vol, veh/h	28	11	28	68	25	31
Conflicting Peds, #/hr	0	0	0	0	0	0
Sign Control	Stop	Stop	Free	Free	Free	Free
RT Channelized	-	None	-	None	-	None
Storage Length	0	-	-	-	-	-
Veh in Median Storage, #	0	-	0	-	-	0
Grade, %	0	-	0	-	-	0
Peak Hour Factor	87	87	87	87	87	87
Heavy Vehicles, %	2	2	2	2	2	2
Mvmt Flow	32	13	32	78	29	36

Major/Minor	Minor1	Major1	Major2			
Conflicting Flow All	165	71	0	0	110	0
Stage 1	71	-	-	-	-	-
Stage 2	94	-	-	-	-	-
Critical Hdwy	6.42	6.22	-	-	4.12	-
Critical Hdwy Stg 1	5.42	-	-	-	-	-
Critical Hdwy Stg 2	5.42	-	-	-	-	-
Follow-up Hdwy	3.518	3.318	-	-	2.218	-
Pot Cap-1 Maneuver	826	991	-	-	1480	-
Stage 1	952	-	-	-	-	-
Stage 2	930	-	-	-	-	-
Platoon blocked, %			-	-	-	-
Mov Cap-1 Maneuver	809	991	-	-	1480	-
Mov Cap-2 Maneuver	809	-	-	-	-	-
Stage 1	933	-	-	-	-	-
Stage 2	930	-	-	-	-	-

Approach	WB	NB	SB
HCM Control Delay, s	9.5	0	3.3
HCM LOS	A		

Minor Lane/Major Mvmt	NBT	NBRWBLn1	SBL	SBT
Capacity (veh/h)	-	-	853	1480
HCM Lane V/C Ratio	-	-	0.053	0.019
HCM Control Delay (s)	-	-	9.5	7.5
HCM Lane LOS	-	-	A	A
HCM 95th %tile Q(veh)	-	-	0.2	0.1

Intersection						
Int Delay, s/veh	3.5					
Movement	EBL	EBR	NBL	NBT	SBT	SBR
Lane Configurations	T			T		T
Traffic Vol, veh/h	43	37	36	104	69	18
Future Vol, veh/h	43	37	36	104	69	18
Conflicting Peds, #/hr	0	0	0	0	0	0
Sign Control	Stop	Stop	Free	Free	Free	Free
RT Channelized	-	None	-	None	-	None
Storage Length	0	-	-	-	-	-
Veh in Median Storage, #	0	-	-	0	0	-
Grade, %	0	-	-	0	0	-
Peak Hour Factor	86	86	86	86	86	86
Heavy Vehicles, %	2	2	2	2	2	2
Mvmt Flow	50	43	42	121	80	21

Major/Minor	Minor2	Major1		Major2	
Conflicting Flow All	296	91	101	0	0
Stage 1	91	-	-	-	-
Stage 2	205	-	-	-	-
Critical Hdwy	6.42	6.22	4.12	-	-
Critical Hdwy Stg 1	5.42	-	-	-	-
Critical Hdwy Stg 2	5.42	-	-	-	-
Follow-up Hdwy	3.518	3.318	2.218	-	-
Pot Cap-1 Maneuver	695	967	1491	-	-
Stage 1	933	-	-	-	-
Stage 2	829	-	-	-	-
Platoon blocked, %				-	-
Mov Cap-1 Maneuver	674	967	1491	-	-
Mov Cap-2 Maneuver	674	-	-	-	-
Stage 1	905	-	-	-	-
Stage 2	829	-	-	-	-

Approach	EB	NB	SB
HCM Control Delay, s	10.2	1.9	0
HCM LOS	B		

Minor Lane/Major Mvmt	NBL	NBT	EBLn1	SBT	SBR
Capacity (veh/h)	1491	-	784	-	-
HCM Lane V/C Ratio	0.028	-	0.119	-	-
HCM Control Delay (s)	7.5	0	10.2	-	-
HCM Lane LOS	A	A	B	-	-
HCM 95th %tile Q(veh)	0.1	-	0.4	-	-

Intersection						
Int Delay, s/veh	3.6					
Movement	EBL	EBT	WBT	WBR	SBL	SBR
Lane Configurations	↘	↑	↑	↗	↘	↘
Traffic Vol, veh/h	58	316	196	136	129	18
Future Vol, veh/h	58	316	196	136	129	18
Conflicting Peds, #/hr	0	0	0	0	0	0
Sign Control	Free	Free	Free	Free	Stop	Stop
RT Channelized	-	None	-	None	-	None
Storage Length	165	-	-	80	0	-
Veh in Median Storage, #	-	0	0	-	0	-
Grade, %	-	0	0	-	0	-
Peak Hour Factor	97	97	97	97	97	97
Heavy Vehicles, %	2	2	2	2	2	2
Mvmt Flow	60	326	202	140	133	19

Major/Minor	Major1	Major2	Minor2		
Conflicting Flow All	342	0	-	0	648 202
Stage 1	-	-	-	-	202 -
Stage 2	-	-	-	-	446 -
Critical Hdwy	4.12	-	-	-	6.42 6.22
Critical Hdwy Stg 1	-	-	-	-	5.42 -
Critical Hdwy Stg 2	-	-	-	-	5.42 -
Follow-up Hdwy	2.218	-	-	-	3.518 3.318
Pot Cap-1 Maneuver	1217	-	-	-	435 839
Stage 1	-	-	-	-	832 -
Stage 2	-	-	-	-	645 -
Platoon blocked, %		-	-	-	
Mov Cap-1 Maneuver	1217	-	-	-	414 839
Mov Cap-2 Maneuver	-	-	-	-	414 -
Stage 1	-	-	-	-	791 -
Stage 2	-	-	-	-	645 -

Approach	EB	WB	SB
HCM Control Delay, s	1.3	0	17.4
HCM LOS			C

Minor Lane/Major Mvmt	EBL	EBT	WBT	WBR	SBLn1
Capacity (veh/h)	1217	-	-	-	441
HCM Lane V/C Ratio	0.049	-	-	-	0.344
HCM Control Delay (s)	8.1	-	-	-	17.4
HCM Lane LOS	A	-	-	-	C
HCM 95th %tile Q(veh)	0.2	-	-	-	1.5

HCM 2010 Signalized Intersection Summary
 16: SR-76 & Old River Rd/East Vista Way

Existing PM Peak Hour
 07/10/2019

Movement	EBL	EBT	EBR	WBL	WBT	WBR	NBL	NBT	NBR	SBL	SBT	SBR
Lane Configurations												
Traffic Volume (veh/h)	14	36	131	196	43	638	64	1663	274	503	976	21
Future Volume (veh/h)	14	36	131	196	43	638	64	1663	274	503	976	21
Number	7	4	14	3	8	18	5	2	12	1	6	16
Initial Q (Qb), veh	0	0	0	0	0	0	0	0	0	0	0	0
Ped-Bike Adj(A_pbT)	1.00		1.00	1.00		1.00	1.00		1.00	1.00		1.00
Parking Bus, Adj	1.00	1.00	1.00	1.00	1.00	1.00	1.00	1.00	1.00	1.00	1.00	1.00
Adj Sat Flow, veh/h/ln	1900	1863	1900	1863	1863	1863	1863	1863	1863	1863	1863	1900
Adj Flow Rate, veh/h	15	38	136	236	0	665	67	1732	285	524	1017	22
Adj No. of Lanes	0	2	0	2	0	1	1	3	1	2	3	0
Peak Hour Factor	0.96	0.96	0.96	0.96	0.96	0.96	0.96	0.96	0.96	0.96	0.96	0.96
Percent Heavy Veh, %	2	2	2	2	2	2	2	2	2	2	2	2
Cap, veh/h	51	130	157	694	0	575	89	2055	640	577	2673	58
Arrive On Green	0.10	0.10	0.10	0.20	0.00	0.20	0.05	0.40	0.40	0.17	0.52	0.52
Sat Flow, veh/h	520	1317	1583	3548	0	1583	1774	5085	1583	3442	5123	111
Grp Volume(v), veh/h	53	0	136	236	0	665	67	1732	285	524	673	366
Grp Sat Flow(s),veh/h/ln	1837	0	1583	1774	0	1583	1774	1695	1583	1721	1695	1843
Q Serve(g_s), s	5.2	0.0	16.5	11.1	0.0	38.0	7.2	59.8	25.4	29.1	23.0	23.0
Cycle Q Clear(g_c), s	5.2	0.0	16.5	11.1	0.0	38.0	7.2	59.8	25.4	29.1	23.0	23.0
Prop In Lane	0.28		1.00	1.00		1.00	1.00		1.00	1.00		0.06
Lane Grp Cap(c), veh/h	182	0	157	694	0	575	89	2055	640	577	1769	962
V/C Ratio(X)	0.29	0.00	0.87	0.34	0.00	1.16	0.75	0.84	0.45	0.91	0.38	0.38
Avail Cap(c_a), veh/h	284	0	244	694	0	575	274	2302	717	744	1769	962
HCM Platoon Ratio	1.00	1.00	1.00	1.00	1.00	1.00	1.00	1.00	1.00	1.00	1.00	1.00
Upstream Filter(I)	1.00	0.00	1.00	1.00	0.00	1.00	1.00	1.00	1.00	1.00	1.00	1.00
Uniform Delay (d), s/veh	81.3	0.0	86.3	67.4	0.0	61.9	91.1	52.3	42.1	79.4	27.7	27.7
Incr Delay (d2), s/veh	0.9	0.0	17.8	0.3	0.0	88.8	12.1	2.8	0.5	12.7	0.1	0.2
Initial Q Delay(d3),s/veh	0.0	0.0	0.0	0.0	0.0	0.0	0.0	0.0	0.0	0.0	0.0	0.0
%ile BackOfQ(50%),veh/ln	2.7	0.0	8.0	5.5	0.0	45.1	3.9	28.6	11.2	14.8	10.8	11.8
LnGrp Delay(d),s/veh	82.1	0.0	104.1	67.7	0.0	150.7	103.3	55.1	42.6	92.1	27.9	28.0
LnGrp LOS	F		F	E		F	F	E	D	F	C	C
Approach Vol, veh/h		189			901			2084			1563	
Approach Delay, s/veh		97.9			128.9			54.9			49.4	
Approach LOS		F			F			D			D	
Timer	1	2	3	4	5	6	7	8				
Assigned Phs	1	2		4	5	6		8				
Phs Duration (G+Y+Rc), s	38.3	86.1		25.6	15.4	108.9		44.4				
Change Period (Y+Rc), s	* 5.7	7.5		6.4	* 5.7	7.5		6.4				
Max Green Setting (Gmax), s	* 42	88.0		30.0	* 30	87.0		38.0				
Max Q Clear Time (g_c+I1), s	31.1	61.8		18.5	9.2	25.0		40.0				
Green Ext Time (p_c), s	1.5	16.7		0.8	0.1	9.0		0.0				
Intersection Summary												
HCM 2010 Ctrl Delay			68.9									
HCM 2010 LOS			E									
Notes												

HCM 2010 Signalized Intersection Summary
 17: SR-76 & N River Rd

Existing PM Peak Hour
 07/10/2019



Movement	EBL	EBR	NBL	NBT	SBT	SBR		
Lane Configurations								
Traffic Volume (veh/h)	343	220	105	2193	1326	184		
Future Volume (veh/h)	343	220	105	2193	1326	184		
Number	7	14	5	2	6	16		
Initial Q (Qb), veh	0	0	0	0	0	0		
Ped-Bike Adj(A_pbT)	1.00	1.00	1.00			1.00		
Parking Bus, Adj	1.00	1.00	1.00	1.00	1.00	1.00		
Adj Sat Flow, veh/h/ln	1863	1863	1863	1863	1863	1863		
Adj Flow Rate, veh/h	357	229	109	2284	1381	192		
Adj No. of Lanes	1	1	1	2	2	1		
Peak Hour Factor	0.96	0.96	0.96	0.96	0.96	0.96		
Percent Heavy Veh, %	2	2	2	2	2	2		
Cap, veh/h	398	355	136	2365	1935	865		
Arrive On Green	0.22	0.22	0.08	0.67	0.55	0.55		
Sat Flow, veh/h	1774	1583	1774	3632	3632	1583		
Grp Volume(v), veh/h	357	229	109	2284	1381	192		
Grp Sat Flow(s),veh/h/ln	1774	1583	1774	1770	1770	1583		
Q Serve(g_s), s	24.7	16.6	7.7	76.4	36.7	7.9		
Cycle Q Clear(g_c), s	24.7	16.6	7.7	76.4	36.7	7.9		
Prop In Lane	1.00	1.00	1.00			1.00		
Lane Grp Cap(c), veh/h	398	355	136	2365	1935	865		
V/C Ratio(X)	0.90	0.64	0.80	0.97	0.71	0.22		
Avail Cap(c_a), veh/h	561	501	407	2377	3356	1502		
HCM Platoon Ratio	1.00	1.00	1.00	1.00	1.00	1.00		
Upstream Filter(I)	1.00	1.00	1.00	1.00	1.00	1.00		
Uniform Delay (d), s/veh	47.6	44.5	57.5	19.6	21.3	14.8		
Incr Delay (d2), s/veh	13.2	2.0	10.5	11.5	0.5	0.1		
Initial Q Delay(d3),s/veh	0.0	0.0	0.0	0.0	0.0	0.0		
%ile BackOfQ(50%),veh/ln	13.6	14.5	4.1	40.6	18.0	3.5		
LnGrp Delay(d),s/veh	60.8	46.5	68.0	31.2	21.8	14.9		
LnGrp LOS	E	D	E	C	C	B		
Approach Vol, veh/h	586			2393	1573			
Approach Delay, s/veh	55.2			32.9	21.0			
Approach LOS	E			C	C			
Timer	1	2	3	4	5	6	7	8
Assigned Phs		2		4	5	6		
Phs Duration (G+Y+Rc), s		92.0		34.5	15.4	76.7		
Change Period (Y+Rc), s		7.5		6.1	* 5.7	7.5		
Max Green Setting (Gmax), s		85.0		40.0	* 29	120.0		
Max Q Clear Time (g_c+I1), s		78.4		26.7	9.7	38.7		
Green Ext Time (p_c), s		6.1		1.7	0.2	18.6		
Intersection Summary								
HCM 2010 Ctrl Delay			31.6					
HCM 2010 LOS			C					
Notes								

HCM 2010 Signalized Intersection Summary
 18: SR-76 & Via Montellano

Existing PM Peak Hour
 07/10/2019



Movement	EBL	EBR	NBL	NBT	SBT	SBR		
Lane Configurations								
Traffic Volume (veh/h)	5	3	10	2532	1505	5		
Future Volume (veh/h)	5	3	10	2532	1505	5		
Number	7	14	5	2	6	16		
Initial Q (Qb), veh	0	0	0	0	0	0		
Ped-Bike Adj(A_pbT)	1.00	1.00	1.00			1.00		
Parking Bus, Adj	1.00	1.00	1.00	1.00	1.00	1.00		
Adj Sat Flow, veh/h/ln	1863	1900	1863	1863	1863	1863		
Adj Flow Rate, veh/h	5	3	11	2694	1601	5		
Adj No. of Lanes	0	0	1	2	2	1		
Peak Hour Factor	0.94	0.94	0.94	0.94	0.94	0.94		
Percent Heavy Veh, %	0	0	2	2	2	2		
Cap, veh/h	21	13	42	2967	2676	1197		
Arrive On Green	0.02	0.02	0.02	0.84	0.76	0.76		
Sat Flow, veh/h	952	571	1774	3632	3632	1583		
Grp Volume(v), veh/h	9	0	11	2694	1601	5		
Grp Sat Flow(s),veh/h/ln	1714	0	1774	1770	1770	1583		
Q Serve(g_s), s	0.5	0.0	0.6	50.2	19.6	0.1		
Cycle Q Clear(g_c), s	0.5	0.0	0.6	50.2	19.6	0.1		
Prop In Lane	0.56	0.33	1.00			1.00		
Lane Grp Cap(c), veh/h	38	0	42	2967	2676	1197		
V/C Ratio(X)	0.24	0.00	0.26	0.91	0.60	0.00		
Avail Cap(c_a), veh/h	597	0	436	3083	3156	1412		
HCM Platoon Ratio	1.00	1.00	1.00	1.00	1.00	1.00		
Upstream Filter(I)	1.00	0.00	1.00	1.00	1.00	1.00		
Uniform Delay (d), s/veh	46.9	0.0	46.8	5.3	5.3	2.9		
Incr Delay (d2), s/veh	3.1	0.0	3.2	4.3	0.2	0.0		
Initial Q Delay(d3),s/veh	0.0	0.0	0.0	0.0	0.0	0.0		
%ile BackOfQ(50%),veh/ln	0.3	0.0	0.3	25.0	9.4	0.0		
LnGrp Delay(d),s/veh	50.0	0.0	50.0	9.7	5.5	2.9		
LnGrp LOS	D		D	A	A	A		
Approach Vol, veh/h	9			2705	1606			
Approach Delay, s/veh	50.0			9.8	5.5			
Approach LOS	D			A	A			
Timer	1	2	3	4	5	6	7	8
Assigned Phs		2		4	5	6		
Phs Duration (G+Y+Rc), s		89.3		8.3	8.0	81.3		
Change Period (Y+Rc), s		7.5		6.1	* 5.7	7.5		
Max Green Setting (Gmax), s		85.0		34.0	* 24	87.0		
Max Q Clear Time (g_c+I1), s		52.2		2.5	2.6	21.6		
Green Ext Time (p_c), s		29.6		0.0	0.0	22.0		
Intersection Summary								
HCM 2010 Ctrl Delay			8.3					
HCM 2010 LOS			A					
Notes								

HCM 2010 Signalized Intersection Summary
 19: I-15 SB Ramps & Highway 76

Existing PM Peak Hour
 07/10/2019



Movement	EBL	EBT	EBR	WBL	WBT	WBR	NBL	NBT	NBR	SBL	SBT	SBR
Lane Configurations		↑↑↑	↗		↑↑	↗				↖	↔	↗
Traffic Volume (veh/h)	0	1051	207	0	645	125	0	0	0	57	0	693
Future Volume (veh/h)	0	1051	207	0	645	125	0	0	0	57	0	693
Number	5	2	12	1	6	16				7	4	14
Initial Q (Qb), veh	0	0	0	0	0	0				0	0	0
Ped-Bike Adj(A_pbT)	1.00		1.00	1.00		1.00				1.00		1.00
Parking Bus, Adj	1.00	1.00	1.00	1.00	1.00	1.00				1.00	1.00	1.00
Adj Sat Flow, veh/h/ln	0	1863	1863	0	1863	1863				1863	1863	1863
Adj Flow Rate, veh/h	0	1072	211	0	658	128				39	0	728
Adj No. of Lanes	0	3	1	0	2	1				1	0	2
Peak Hour Factor	0.98	0.98	0.98	0.98	0.98	0.98				0.98	0.98	0.98
Percent Heavy Veh, %	0	2	2	0	2	2				2	2	2
Cap, veh/h	0	2119	660	0	1475	1157				557	0	994
Arrive On Green	0.00	0.42	0.42	0.00	0.42	0.42				0.31	0.00	0.31
Sat Flow, veh/h	0	5253	1583	0	3632	1583				1774	0	3167
Grp Volume(v), veh/h	0	1072	211	0	658	128				39	0	728
Grp Sat Flow(s),veh/h/ln	0	1695	1583	0	1770	1583				1774	0	1583
Q Serve(g_s), s	0.0	7.9	4.5	0.0	6.7	1.2				0.8	0.0	10.3
Cycle Q Clear(g_c), s	0.0	7.9	4.5	0.0	6.7	1.2				0.8	0.0	10.3
Prop In Lane	0.00		1.00	0.00		1.00				1.00		1.00
Lane Grp Cap(c), veh/h	0	2119	660	0	1475	1157				557	0	994
V/C Ratio(X)	0.00	0.51	0.32	0.00	0.45	0.11				0.07	0.00	0.73
Avail Cap(c_a), veh/h	0	5540	1725	0	4066	2316				1757	0	3136
HCM Platoon Ratio	1.00	1.00	1.00	1.00	1.00	1.00				1.00	1.00	1.00
Upstream Filter(I)	0.00	1.00	1.00	0.00	1.00	1.00				1.00	0.00	1.00
Uniform Delay (d), s/veh	0.0	10.9	9.9	0.0	10.6	2.0				12.1	0.0	15.4
Incr Delay (d2), s/veh	0.0	0.2	0.3	0.0	0.2	0.0				0.1	0.0	1.1
Initial Q Delay(d3),s/veh	0.0	0.0	0.0	0.0	0.0	0.0				0.0	0.0	0.0
%ile BackOfQ(50%),veh/ln	0.0	3.7	2.0	0.0	3.3	1.2				0.4	0.0	4.6
LnGrp Delay(d),s/veh	0.0	11.1	10.2	0.0	10.8	2.0				12.2	0.0	16.5
LnGrp LOS		B	B		B	A				B		B
Approach Vol, veh/h		1283			786						767	
Approach Delay, s/veh		10.9			9.3						16.3	
Approach LOS		B			A						B	
Timer	1	2	3	4	5	6	7	8				
Assigned Phs		2		4		6						
Phs Duration (G+Y+Rc), s		28.5		22.0		28.5						
Change Period (Y+Rc), s		7.5		6.1		7.5						
Max Green Setting (Gmax), s		55.0		50.0		58.0						
Max Q Clear Time (g_c+I1), s		9.9		12.3		8.7						
Green Ext Time (p_c), s		11.2		3.5		5.8						
Intersection Summary												
HCM 2010 Ctrl Delay				11.9								
HCM 2010 LOS				B								
Notes												

HCM 2010 Signalized Intersection Summary
 20: I-15 NB Ramps & Highway 76

Existing PM Peak Hour
 07/10/2019



























Movement	EBL	EBT	EBR	WBL	WBT	WBR	NBL	NBT	NBR	SBL	SBT	SBR
Lane Configurations		↑↑	↑		↑↑↑	↑	↑	↑	↑			
Traffic Volume (veh/h)	0	472	628	0	303	52	430	0	766	0	0	0
Future Volume (veh/h)	0	472	628	0	303	52	430	0	766	0	0	0
Number	5	2	12	1	6	16	3	8	18			
Initial Q (Qb), veh	0	0	0	0	0	0	0	0	0			
Ped-Bike Adj(A_pbT)	1.00		1.00	1.00		1.00	1.00		1.00			
Parking Bus, Adj	1.00	1.00	1.00	1.00	1.00	1.00	1.00	1.00	1.00			
Adj Sat Flow, veh/h/ln	0	1863	1863	0	1863	1863	1863	1863	1863			
Adj Flow Rate, veh/h	0	482	641	0	309	53	293	0	939			
Adj No. of Lanes	0	2	1	0	3	1	1	0	2			
Peak Hour Factor	0.98	0.98	0.98	0.98	0.98	0.98	0.98	0.98	0.98			
Percent Heavy Veh, %	0	2	2	0	2	2	2	2	2			
Cap, veh/h	0	1216	1176	0	1748	544	708	0	1264			
Arrive On Green	0.00	0.34	0.34	0.00	0.34	0.34	0.40	0.00	0.40			
Sat Flow, veh/h	0	3632	1583	0	5253	1583	1774	0	3167			
Grp Volume(v), veh/h	0	482	641	0	309	53	293	0	939			
Grp Sat Flow(s),veh/h/ln	0	1770	1583	0	1695	1583	1774	0	1583			
Q Serve(g_s), s	0.0	5.5	9.3	0.0	2.2	1.2	6.3	0.0	13.4			
Cycle Q Clear(g_c), s	0.0	5.5	9.3	0.0	2.2	1.2	6.3	0.0	13.4			
Prop In Lane	0.00		1.00	0.00		1.00	1.00		1.00			
Lane Grp Cap(c), veh/h	0	1216	1176	0	1748	544	708	0	1264			
V/C Ratio(X)	0.00	0.40	0.54	0.00	0.18	0.10	0.41	0.00	0.74			
Avail Cap(c_a), veh/h	0	3412	2159	0	3461	1078	1476	0	2634			
HCM Platoon Ratio	1.00	1.00	1.00	1.00	1.00	1.00	1.00	1.00	1.00			
Upstream Filter(I)	0.00	1.00	1.00	0.00	1.00	1.00	1.00	0.00	1.00			
Uniform Delay (d), s/veh	0.0	13.2	2.9	0.0	12.1	11.8	11.4	0.0	13.6			
Incr Delay (d2), s/veh	0.0	0.2	0.4	0.0	0.0	0.1	0.4	0.0	0.9			
Initial Q Delay(d3),s/veh	0.0	0.0	0.0	0.0	0.0	0.0	0.0	0.0	0.0			
%ile BackOfQ(50%),veh/ln	0.0	2.7	9.2	0.0	1.0	0.5	3.1	0.0	5.9			
LnGrp Delay(d),s/veh	0.0	13.4	3.3	0.0	12.2	11.9	11.8	0.0	14.5			
LnGrp LOS		B	A		B	B	B		B			
Approach Vol, veh/h		1123			362			1232				
Approach Delay, s/veh		7.7			12.1			13.8				
Approach LOS		A			B			B				
Timer	1	2	3	4	5	6	7	8				
Assigned Phs		2				6		8				
Phs Duration (G+Y+Rc), s		25.7				25.7		27.2				
Change Period (Y+Rc), s		7.5				7.5		6.1				
Max Green Setting (Gmax), s		51.0				36.0		44.0				
Max Q Clear Time (g_c+I1), s		11.3				4.2		15.4				
Green Ext Time (p_c), s		6.9				2.4		5.7				
Intersection Summary												
HCM 2010 Ctrl Delay					11.0							
HCM 2010 LOS					B							
Notes												

HCM 2010 Signalized Intersection Summary
 1: Highway 76 & Olive Hill Road/Camino Del Rey

Existing + Project AM Peak Hour

07/10/2019

												
Movement	EBL	EBT	EBR	WBL	WBT	WBR	NBL	NBT	NBR	SBL	SBT	SBR
Lane Configurations												
Traffic Volume (veh/h)	96	181	148	155	68	219	88	990	180	547	2015	46
Future Volume (veh/h)	96	181	148	155	68	219	88	990	180	547	2015	46
Number	7	4	14	3	8	18	5	2	12	1	6	16
Initial Q (Qb), veh	0	0	0	0	0	0	0	0	0	0	0	0
Ped-Bike Adj(A_pbT)	1.00		1.00	1.00		1.00	1.00		1.00	1.00		1.00
Parking Bus, Adj	1.00	1.00	1.00	1.00	1.00	1.00	1.00	1.00	1.00	1.00	1.00	1.00
Adj Sat Flow, veh/h/ln	1863	1863	1863	1863	1863	1863	1863	1863	1863	1863	1863	1863
Adj Flow Rate, veh/h	104	197	161	168	74	238	96	1076	196	595	2190	50
Adj No. of Lanes	2	1	1	1	1	1	1	3	1	2	3	1
Peak Hour Factor	0.92	0.92	0.92	0.92	0.92	0.92	0.92	0.92	0.92	0.92	0.92	0.92
Percent Heavy Veh, %	2	2	2	2	2	2	2	2	2	2	2	2
Cap, veh/h	426	231	196	298	313	266	164	1922	598	660	2428	756
Arrive On Green	0.12	0.12	0.12	0.17	0.17	0.17	0.09	0.38	0.38	0.19	0.48	0.48
Sat Flow, veh/h	3442	1863	1583	1774	1863	1583	1774	5085	1583	3442	5085	1583
Grp Volume(v), veh/h	104	197	161	168	74	238	96	1076	196	595	2190	50
Grp Sat Flow(s),veh/h/ln	1721	1863	1583	1774	1863	1583	1774	1695	1583	1721	1695	1583
Q Serve(g_s), s	5.0	19.0	18.2	15.9	6.3	26.9	9.5	30.6	16.1	30.9	72.3	3.1
Cycle Q Clear(g_c), s	5.0	19.0	18.2	15.9	6.3	26.9	9.5	30.6	16.1	30.9	72.3	3.1
Prop In Lane	1.00		1.00	1.00		1.00	1.00		1.00	1.00		1.00
Lane Grp Cap(c), veh/h	426	231	196	298	313	266	164	1922	598	660	2428	756
V/C Ratio(X)	0.24	0.85	0.82	0.56	0.24	0.90	0.59	0.56	0.33	0.90	0.90	0.07
Avail Cap(c_a), veh/h	639	346	294	514	539	459	291	2501	779	978	2501	779
HCM Platoon Ratio	1.00	1.00	1.00	1.00	1.00	1.00	1.00	1.00	1.00	1.00	1.00	1.00
Upstream Filter(I)	1.00	1.00	1.00	1.00	1.00	1.00	1.00	1.00	1.00	1.00	1.00	1.00
Uniform Delay (d), s/veh	72.4	78.6	78.2	70.0	66.0	74.6	79.7	44.9	40.4	72.3	43.9	25.8
Incr Delay (d2), s/veh	0.3	12.5	10.8	1.7	0.4	11.5	3.3	0.3	0.3	8.2	4.9	0.0
Initial Q Delay(d3),s/veh	0.0	0.0	0.0	0.0	0.0	0.0	0.0	0.0	0.0	0.0	0.0	0.0
%ile BackOfQ(50%),veh/ln	2.4	10.6	8.6	8.0	3.3	12.6	4.8	14.4	7.1	15.5	35.0	1.4
LnGrp Delay(d),s/veh	72.7	91.0	89.0	71.7	66.4	86.1	83.0	45.2	40.7	80.5	48.8	25.8
LnGrp LOS	E	F	F	E	E	F	F	D	D	F	D	C
Approach Vol, veh/h		462			480			1368			2835	
Approach Delay, s/veh		86.2			78.0			47.2			55.1	
Approach LOS		F			E			D			E	
Timer	1	2	3	4	5	6	7	8				
Assigned Phs	1	2		4	5	6		8				
Phs Duration (G+Y+Rc), s	40.8	76.7		28.8	22.6	94.9		36.8				
Change Period (Y+Rc), s	* 5.7	7.5		6.1	* 5.7	7.5		6.1				
Max Green Setting (Gmax), s	* 52	90.0		34.0	* 30	90.0		53.0				
Max Q Clear Time (g_c+I1), s	32.9	32.6		21.0	11.5	74.3		28.9				
Green Ext Time (p_c), s	2.1	11.5		1.7	0.2	13.0		1.8				
Intersection Summary												
HCM 2010 Ctrl Delay				57.9								
HCM 2010 LOS				E								
Notes												

Intersection						
Int Delay, s/veh	0					
Movement	EBL	EBR	NBL	NBT	SBT	SBR
Lane Configurations	Y		Y	↑	↑	Y
Traffic Vol, veh/h	635	214	159	65	90	342
Future Vol, veh/h	635	214	159	65	90	342
Conflicting Peds, #/hr	0	0	0	0	0	0
Sign Control	Free	Free	Stop	Stop	Free	Free
RT Channelized	-	Free	-	None	-	Free
Storage Length	0	-	150	-	-	150
Veh in Median Storage, #	-	-	-	0	0	-
Grade, %	0	-	-	0	0	-
Peak Hour Factor	82	82	82	82	82	82
Heavy Vehicles, %	2	2	2	2	2	2
Mvmt Flow	774	261	194	79	110	417

Major/Minor	Minor2	Major2		
Conflicting Flow All	110	110	-	0
Stage 1	110	110	-	-
Stage 2	0	0	-	-
Critical Hdwy	6.42	6.52	-	-
Critical Hdwy Stg 1	5.42	5.52	-	-
Critical Hdwy Stg 2	-	-	-	-
Follow-up Hdwy	3.518	4.018	-	-
Pot Cap-1 Maneuver	887	780	-	0
Stage 1	915	804	-	0
Stage 2	-	-	-	0
Platoon blocked, %			-	
Mov Cap-1 Maneuver	887	0	-	-
Mov Cap-2 Maneuver	887	0	-	-
Stage 1	915	0	-	-
Stage 2	-	0	-	-

Approach	NB	SB
HCM Control Delay, s		0
HCM LOS	-	

Minor Lane/Major Mvmt	NBLn1	NBLn2	SBT
Capacity (veh/h)	887	-	-
HCM Lane V/C Ratio	0.219	-	-
HCM Control Delay (s)	10.2	-	-
HCM Lane LOS	B	-	-
HCM 95th %tile Q(veh)	0.8	-	-

Intersection						
Int Delay, s/veh	6					
Movement	EBL	EBT	WBT	WBR	SBL	SBR
Lane Configurations		↔	↔		↔	↔
Traffic Vol, veh/h	331	374	317	24	21	237
Future Vol, veh/h	331	374	317	24	21	237
Conflicting Peds, #/hr	0	0	0	0	0	0
Sign Control	Free	Free	Free	Free	Stop	Stop
RT Channelized	-	None	-	None	-	Stop
Storage Length	-	-	-	-	0	100
Veh in Median Storage, #	-	0	0	-	0	-
Grade, %	-	0	0	-	0	-
Peak Hour Factor	90	90	90	90	90	90
Heavy Vehicles, %	2	2	2	2	2	2
Mvmt Flow	368	416	352	27	23	263

Major/Minor	Major1	Major2	Minor2		
Conflicting Flow All	379	0	-	0	1518 366
Stage 1	-	-	-	-	366 -
Stage 2	-	-	-	-	1152 -
Critical Hdwy	4.12	-	-	-	6.42 6.22
Critical Hdwy Stg 1	-	-	-	-	5.42 -
Critical Hdwy Stg 2	-	-	-	-	5.42 -
Follow-up Hdwy	2.218	-	-	-	3.518 3.318
Pot Cap-1 Maneuver	1179	-	-	-	131 679
Stage 1	-	-	-	-	702 -
Stage 2	-	-	-	-	301 -
Platoon blocked, %		-	-	-	
Mov Cap-1 Maneuver	1179	-	-	-	78 679
Mov Cap-2 Maneuver	-	-	-	-	78 -
Stage 1	-	-	-	-	417 -
Stage 2	-	-	-	-	301 -

























Approach	EB	WB	SB
HCM Control Delay, s	4.4	0	18.2
HCM LOS			C

Minor Lane/Major Mvmt	EBL	EBT	WBT	WBR	SBLn1	SBLn2
Capacity (veh/h)	1179	-	-	-	78	679
HCM Lane V/C Ratio	0.312	-	-	-	0.299	0.388
HCM Control Delay (s)	9.4	0	-	-	69.8	13.6
HCM Lane LOS	A	A	-	-	F	B
HCM 95th %tile Q(veh)	1.3	-	-	-	1.1	1.8

HCM 2010 Signalized Intersection Summary
 4: Old Highway 395 & Highway 76

Existing + Project AM Peak Hour

07/10/2019

												
Movement	EBL	EBT	EBR	WBL	WBT	WBR	NBL	NBT	NBR	SBL	SBT	SBR
Lane Configurations												
Traffic Volume (veh/h)	79	688	157	261	1098	79	166	75	81	126	310	154
Future Volume (veh/h)	79	688	157	261	1098	79	166	75	81	126	310	154
Number	5	2	12	1	6	16	3	8	18	7	4	14
Initial Q (Qb), veh	0	0	0	0	0	0	0	0	0	0	0	0
Ped-Bike Adj(A_pbT)	1.00		1.00	1.00		1.00	1.00		1.00	1.00		1.00
Parking Bus, Adj	1.00	1.00	1.00	1.00	1.00	1.00	1.00	1.00	1.00	1.00	1.00	1.00
Adj Sat Flow, veh/h/ln	1863	1863	1863	1863	1863	1863	1863	1863	1863	1863	1863	1900
Adj Flow Rate, veh/h	82	717	63	272	1144	0	173	78	10	131	323	155
Adj No. of Lanes	1	3	1	1	2	1	1	1	1	2	1	0
Peak Hour Factor	0.96	0.96	0.96	0.96	0.96	0.96	0.96	0.96	0.96	0.96	0.96	0.96
Percent Heavy Veh, %	2	2	2	2	2	2	2	2	2	2	2	2
Cap, veh/h	165	1428	445	291	1247	1040	195	162	398	1047	348	167
Arrive On Green	0.09	0.28	0.28	0.16	0.35	0.00	0.11	0.09	0.09	0.30	0.29	0.29
Sat Flow, veh/h	1774	5085	1583	1774	3539	1583	1774	1863	1583	3442	1191	571
Grp Volume(v), veh/h	82	717	63	272	1144	0	173	78	10	131	0	478
Grp Sat Flow(s),veh/h/ln	1774	1695	1583	1774	1770	1583	1774	1863	1583	1721	0	1762
Q Serve(g_s), s	7.6	20.4	5.1	26.1	53.3	0.0	16.6	6.9	0.4	4.7	0.0	45.5
Cycle Q Clear(g_c), s	7.6	20.4	5.1	26.1	53.3	0.0	16.6	6.9	0.4	4.7	0.0	45.5
Prop In Lane	1.00		1.00	1.00		1.00	1.00		1.00	1.00		0.32
Lane Grp Cap(c), veh/h	165	1428	445	291	1247	1040	195	162	398	1047	0	514
V/C Ratio(X)	0.50	0.50	0.14	0.93	0.92	0.00	0.89	0.48	0.03	0.13	0.00	0.93
Avail Cap(c_a), veh/h	278	1769	551	319	1334	1079	309	356	563	1047	0	654
HCM Platoon Ratio	1.00	1.00	1.00	1.00	1.00	1.00	1.00	1.00	1.00	1.00	1.00	1.00
Upstream Filter(I)	1.00	1.00	1.00	1.00	1.00	0.00	1.00	1.00	1.00	1.00	0.00	1.00
Uniform Delay (d), s/veh	74.4	51.9	46.4	71.1	53.4	0.0	75.7	75.0	19.6	43.4	0.0	59.3
Incr Delay (d2), s/veh	2.3	0.3	0.1	32.1	9.8	0.0	17.1	2.2	0.0	0.1	0.0	17.2
Initial Q Delay(d3),s/veh	0.0	0.0	0.0	0.0	0.0	0.0	0.0	0.0	0.0	0.0	0.0	0.0
%ile BackOfQ(50%),veh/ln	3.8	9.6	2.3	15.4	27.8	0.0	9.1	3.7	0.2	2.3	0.0	24.6
LnGrp Delay(d),s/veh	76.7	52.2	46.6	103.2	63.3	0.0	92.8	77.2	19.6	43.4	0.0	76.5
LnGrp LOS	E	D	D	F	E		F	E	B	D		E
Approach Vol, veh/h		862			1416			261			609	
Approach Delay, s/veh		54.1			70.9			85.3			69.4	
Approach LOS		D			E			F			E	
Timer	1	2	3	4	5	6	7	8				
Assigned Phs	1	2	3	4	5	6	7	8				
Phs Duration (G+Y+Rc), s	34.0	55.9	24.6	57.8	21.7	68.3	60.0	22.5				
Change Period (Y+Rc), s	* 5.7	7.5	* 5.7	7.5	* 5.7	7.5	7.5	* 7.5				
Max Green Setting (Gmax), s	* 31	60.0	* 30	64.0	* 27	65.0	48.0	* 33				
Max Q Clear Time (g_c+I1), s	28.1	22.4	18.6	47.5	9.6	55.3	6.7	8.9				
Green Ext Time (p_c), s	0.2	6.0	0.3	2.9	0.2	5.4	0.4	0.4				
Intersection Summary												
HCM 2010 Ctrl Delay				67.2								
HCM 2010 LOS				E								
Notes												

Intersection						
Int Delay, s/veh	10.3					
Movement	WBL	WBR	NBT	NBR	SBL	SBT
Lane Configurations						
Traffic Vol, veh/h	172	172	139	40	39	675
Future Vol, veh/h	172	172	139	40	39	675
Conflicting Peds, #/hr	0	0	0	0	0	0
Sign Control	Stop	Stop	Free	Free	Free	Free
RT Channelized	-	None	-	None	-	None
Storage Length	0	385	-	-	-	-
Veh in Median Storage, #	0	-	0	-	-	0
Grade, %	0	-	0	-	-	0
Peak Hour Factor	88	88	88	88	88	88
Heavy Vehicles, %	2	2	2	2	2	2
Mvmt Flow	195	195	158	45	44	767

Major/Minor	Minor1	Major1	Major2		
Conflicting Flow All	1036	181	0	0	203
Stage 1	181	-	-	-	-
Stage 2	855	-	-	-	-
Critical Hdwy	6.42	6.22	-	-	4.12
Critical Hdwy Stg 1	5.42	-	-	-	-
Critical Hdwy Stg 2	5.42	-	-	-	-
Follow-up Hdwy	3.518	3.318	-	-	2.218
Pot Cap-1 Maneuver	256	862	-	-	1369
Stage 1	850	-	-	-	-
Stage 2	417	-	-	-	-
Platoon blocked, %			-	-	-
Mov Cap-1 Maneuver	242	862	-	-	1369
Mov Cap-2 Maneuver	242	-	-	-	-
Stage 1	802	-	-	-	-
Stage 2	417	-	-	-	-

Approach	WB	NB	SB
HCM Control Delay, s	36.2	0	0.4
HCM LOS	E		

Minor Lane/Major Mvmt	NBT	NBRWBLn1	WBLn2	SBL	SBT
Capacity (veh/h)	-	-	242	862	1369
HCM Lane V/C Ratio	-	-	0.808	0.227	0.032
HCM Control Delay (s)	-	-	61.9	10.4	7.7
HCM Lane LOS	-	-	F	B	A
HCM 95th %tile Q(veh)	-	-	6.1	0.9	0.1

Intersection												
Int Delay, s/veh	12.1											
Movement	EBL	EBT	EBR	WBL	WBT	WBR	NBL	NBT	NBR	SBL	SBT	SBR
Lane Configurations		↖	↗		↖	↗	↖	↗		↖	↗	
Traffic Vol, veh/h	125	14	133	24	25	16	89	41	8	19	588	119
Future Vol, veh/h	125	14	133	24	25	16	89	41	8	19	588	119
Conflicting Peds, #/hr	0	0	0	0	0	0	0	0	0	0	0	0
Sign Control	Stop	Stop	Stop	Stop	Stop	Stop	Free	Free	Free	Free	Free	Free
RT Channelized	-	-	Stop	-	-	Stop	-	-	None	-	-	None
Storage Length	-	-	25	-	-	50	210	-	-	200	-	530
Veh in Median Storage, #	-	0	-	-	0	-	-	0	-	-	0	-
Grade, %	-	0	-	-	0	-	-	0	-	-	0	-
Peak Hour Factor	95	95	95	95	95	95	95	95	95	95	95	95
Heavy Vehicles, %	2	2	2	2	2	2	2	2	2	2	2	2
Mvmt Flow	132	15	140	25	26	17	94	43	8	20	619	125

Major/Minor	Minor2		Minor1		Major1		Major2					
Conflicting Flow All	970	961	372	592	1019	47	744	0	0	51	0	0
Stage 1	722	722	-	235	235	-	-	-	-	-	-	-
Stage 2	248	239	-	357	784	-	-	-	-	-	-	-
Critical Hdwy	7.33	6.53	6.93	7.33	6.53	6.23	4.13	-	-	4.13	-	-
Critical Hdwy Stg 1	6.53	5.53	-	6.13	5.53	-	-	-	-	-	-	-
Critical Hdwy Stg 2	6.13	5.53	-	6.53	5.53	-	-	-	-	-	-	-
Follow-up Hdwy	3.519	4.019	3.319	3.519	4.019	3.319	2.219	-	-	2.219	-	-
Pot Cap-1 Maneuver	220	256	626	404	236	1022	861	-	-	1554	-	-
Stage 1	385	430	-	767	710	-	-	-	-	-	-	-
Stage 2	755	707	-	634	403	-	-	-	-	-	-	-
Platoon blocked, %								-	-	-	-	-
Mov Cap-1 Maneuver	178	225	626	271	207	1022	861	-	-	1554	-	-
Mov Cap-2 Maneuver	178	225	-	271	207	-	-	-	-	-	-	-
Stage 1	343	424	-	683	633	-	-	-	-	-	-	-
Stage 2	634	630	-	469	398	-	-	-	-	-	-	-

Approach	EB		WB		NB		SB	
HCM Control Delay, s	45		20.7		6.2		0.2	
HCM LOS	E		C					

Minor Lane/Major Mvmt	NBL	NBT	NBR	EBLn1	EBLn2	WBLn1	WBLn2	SBL	SBT	SBR
Capacity (veh/h)	861	-	-	182	626	234	1022	1554	-	-
HCM Lane V/C Ratio	0.109	-	-	0.804	0.224	0.22	0.016	0.013	-	-
HCM Control Delay (s)	9.7	-	-	76.1	12.4	24.7	8.6	7.3	-	-
HCM Lane LOS	A	-	-	F	B	C	A	A	-	-
HCM 95th %tile Q(veh)	0.4	-	-	5.5	0.9	0.8	0.1	0	-	-

Intersection												
Int Delay, s/veh	5.4											
Movement	EBL	EBT	EBR	WBL	WBT	WBR	NBL	NBT	NBR	SBL	SBT	SBR
Lane Configurations		↑	↗	↖	↑						↖	↗
Traffic Vol, veh/h	0	351	412	7	154	0	0	0	0	185	12	7
Future Vol, veh/h	0	351	412	7	154	0	0	0	0	185	12	7
Conflicting Peds, #/hr	0	0	0	0	0	0	0	0	0	0	0	0
Sign Control	Free	Free	Free	Free	Free	Free	Stop	Stop	Stop	Stop	Stop	Stop
RT Channelized	-	-	Free	-	-	None	-	-	None	-	-	Yield
Storage Length	-	-	390	55	-	-	-	-	-	-	-	32
Veh in Median Storage, #	-	0	-	-	0	-	-	-	-	-	0	-
Grade, %	-	0	-	-	0	-	-	0	-	-	0	-
Peak Hour Factor	90	90	90	90	90	90	90	90	90	90	90	90
Heavy Vehicles, %	2	2	2	2	2	2	2	2	2	2	2	2
Mvmt Flow	0	390	458	8	171	0	0	0	0	206	13	8

Major/Minor	Major1			Major2			Minor2			
Conflicting Flow All	-	0	-	390	0	0		577	577	171
Stage 1	-	-	-	-	-	-		187	187	-
Stage 2	-	-	-	-	-	-		390	390	-
Critical Hdwy	-	-	-	4.12	-	-		6.42	6.52	6.22
Critical Hdwy Stg 1	-	-	-	-	-	-		5.42	5.52	-
Critical Hdwy Stg 2	-	-	-	-	-	-		5.42	5.52	-
Follow-up Hdwy	-	-	-	2.218	-	-		3.518	4.018	3.318
Pot Cap-1 Maneuver	0	-	0	1169	-	0		478	427	873
Stage 1	0	-	0	-	-	0		845	745	-
Stage 2	0	-	0	-	-	0		684	608	-
Platoon blocked, %		-			-					
Mov Cap-1 Maneuver	-	-	-	1169	-	-		475	0	873
Mov Cap-2 Maneuver	-	-	-	-	-	-		475	0	-
Stage 1	-	-	-	-	-	-		839	0	-
Stage 2	-	-	-	-	-	-		684	0	-

Approach	EB	WB	SB
HCM Control Delay, s	0	0.4	18.6
HCM LOS			C

Minor Lane/Major Mvmt	EBT	WBL	WBT	SBLn1	SBLn2
Capacity (veh/h)	-	1169	-	475	873
HCM Lane V/C Ratio	-	0.007	-	0.461	0.009
HCM Control Delay (s)	-	8.1	-	18.9	9.2
HCM Lane LOS	-	A	-	C	A
HCM 95th %tile Q(veh)	-	0	-	2.4	0

Intersection												
Int Delay, s/veh	2.5											
Movement	EBL	EBT	EBR	WBL	WBT	WBR	NBL	NBT	NBR	SBL	SBT	SBR
Lane Configurations		↑	↑		↑	↑	↑		↑			
Traffic Vol, veh/h	0	528	5	0	59	49	95	0	4	0	0	0
Future Vol, veh/h	0	528	5	0	59	49	95	0	4	0	0	0
Conflicting Peds, #/hr	0	0	0	0	0	0	0	0	0	0	0	0
Sign Control	Free	Free	Free	Free	Free	Free	Stop	Stop	Stop	Stop	Stop	Stop
RT Channelized	-	-	Free	-	-	Free	-	-	Stop	-	-	None
Storage Length	-	-	200	-	-	100	0	-	150	-	-	-
Veh in Median Storage, #	-	0	-	-	0	-	-	0	-	-	16965	-
Grade, %	-	0	-	-	0	-	-	0	-	-	0	-
Peak Hour Factor	83	83	83	83	83	83	83	83	83	83	83	83
Heavy Vehicles, %	2	2	2	2	2	2	2	2	2	2	2	2
Mvmt Flow	0	636	6	0	71	59	114	0	5	0	0	0

Major/Minor	Major1		Major2		Minor1	
Conflicting Flow All	-	0	-	-	0	707
Stage 1	-	-	-	-	-	636
Stage 2	-	-	-	-	-	71
Critical Hdwy	-	-	-	-	-	6.42
Critical Hdwy Stg 1	-	-	-	-	-	5.42
Critical Hdwy Stg 2	-	-	-	-	-	5.42
Follow-up Hdwy	-	-	-	-	-	3.518
Pot Cap-1 Maneuver	0	-	0	0	-	402
Stage 1	0	-	0	0	-	527
Stage 2	0	-	0	0	-	952
Platoon blocked, %	-	-	-	-	-	-
Mov Cap-1 Maneuver	-	-	-	-	-	402
Mov Cap-2 Maneuver	-	-	-	-	-	402
Stage 1	-	-	-	-	-	527
Stage 2	-	-	-	-	-	952

Approach	EB	WB	NB
HCM Control Delay, s	0	0	17.3
HCM LOS			C

Minor Lane/Major Mvmt	NBLn1	NBLn2	EBT	WBT
Capacity (veh/h)	402	478	-	-
HCM Lane V/C Ratio	0.285	0.01	-	-
HCM Control Delay (s)	17.5	12.6	-	-
HCM Lane LOS	C	B	-	-
HCM 95th %tile Q(veh)	1.2	0	-	-

Intersection						
Int Delay, s/veh	9.3					
Movement	EBL	EBR	NBL	NBT	SBT	SBR
Lane Configurations	↘		↘	↑	↑	↘
Traffic Vol, veh/h	21	280	127	78	549	38
Future Vol, veh/h	21	280	127	78	549	38
Conflicting Peds, #/hr	0	0	0	0	0	0
Sign Control	Stop	Stop	Free	Free	Free	Free
RT Channelized	-	None	-	None	-	None
Storage Length	0	-	110	-	-	50
Veh in Median Storage, #	0	-	-	0	0	-
Grade, %	0	-	-	0	0	-
Peak Hour Factor	91	91	91	91	91	91
Heavy Vehicles, %	2	2	2	2	2	2
Mvmt Flow	23	308	140	86	603	42

Major/Minor	Minor2	Major1	Major2			
Conflicting Flow All	969	603	645	0	-	0
Stage 1	603	-	-	-	-	-
Stage 2	366	-	-	-	-	-
Critical Hdwy	6.42	6.22	4.12	-	-	-
Critical Hdwy Stg 1	5.42	-	-	-	-	-
Critical Hdwy Stg 2	5.42	-	-	-	-	-
Follow-up Hdwy	3.518	3.318	2.218	-	-	-
Pot Cap-1 Maneuver	281	499	940	-	-	-
Stage 1	546	-	-	-	-	-
Stage 2	702	-	-	-	-	-
Platoon blocked, %				-	-	-
Mov Cap-1 Maneuver	239	499	940	-	-	-
Mov Cap-2 Maneuver	239	-	-	-	-	-
Stage 1	465	-	-	-	-	-
Stage 2	702	-	-	-	-	-

Approach	EB	NB	SB
HCM Control Delay, s	29.8	5.9	0
HCM LOS	D		

Minor Lane/Major Mvmt	NBL	NBT	EBLn1	SBT	SBR
Capacity (veh/h)	940	-	464	-	-
HCM Lane V/C Ratio	0.148	-	0.713	-	-
HCM Control Delay (s)	9.5	-	29.8	-	-
HCM Lane LOS	A	-	D	-	-
HCM 95th %tile Q(veh)	0.5	-	5.6	-	-

Intersection						
Int Delay, s/veh	42.7					
Movement	WBL	WBR	NBT	NBR	SBL	SBT
Lane Configurations	↔		↔		↔	↔
Traffic Vol, veh/h	243	32	185	77	18	848
Future Vol, veh/h	243	32	185	77	18	848
Conflicting Peds, #/hr	0	0	0	0	0	0
Sign Control	Stop	Stop	Free	Free	Free	Free
RT Channelized	-	None	-	None	-	None
Storage Length	0	-	-	-	165	-
Veh in Median Storage, #	0	-	0	-	-	0
Grade, %	0	-	0	-	-	0
Peak Hour Factor	93	93	93	93	93	93
Heavy Vehicles, %	2	2	2	2	2	2
Mvmt Flow	261	34	199	83	19	912

Major/Minor	Minor1	Major1	Major2		
Conflicting Flow All	1191	241	0	0	282
Stage 1	241	-	-	-	-
Stage 2	950	-	-	-	-
Critical Hdwy	6.42	6.22	-	-	4.12
Critical Hdwy Stg 1	5.42	-	-	-	-
Critical Hdwy Stg 2	5.42	-	-	-	-
Follow-up Hdwy	3.518	3.318	-	-	2.218
Pot Cap-1 Maneuver	~ 207	798	-	-	1280
Stage 1	799	-	-	-	-
Stage 2	376	-	-	-	-
Platoon blocked, %			-	-	-
Mov Cap-1 Maneuver	~ 204	798	-	-	1280
Mov Cap-2 Maneuver	~ 204	-	-	-	-
Stage 1	787	-	-	-	-
Stage 2	376	-	-	-	-













Approach	WB	NB	SB
HCM Control Delay, s	217	0	0.2
HCM LOS	F		

Minor Lane/Major Mvmt	NBT	NBRWBLn1	SBL	SBT
Capacity (veh/h)	-	-	223	1280
HCM Lane V/C Ratio	-	-	1.326	0.015
HCM Control Delay (s)	-	-	217	7.9
HCM Lane LOS	-	-	F	A
HCM 95th %tile Q(veh)	-	-	16	0

Notes
 -: Volume exceeds capacity \$: Delay exceeds 300s +: Computation Not Defined *: All major volume in platoon

HCM 2010 Signalized Intersection Summary
 11: Old Highway 395 & Gopher Canyon Road

Existing + Project AM Peak Hour
 07/10/2019

								
Movement	EBL	EBR	NBL	NBT	SBT	SBR		
Lane Configurations								
Traffic Volume (veh/h)	153	170	287	109	539	549		
Future Volume (veh/h)	153	170	287	109	539	549		
Number	7	14	5	2	6	16		
Initial Q (Qb), veh	0	0	0	0	0	0		
Ped-Bike Adj(A_pbT)	1.00	1.00	1.00			1.00		
Parking Bus, Adj	1.00	1.00	1.00	1.00	1.00	1.00		
Adj Sat Flow, veh/h/ln	1863	1863	1863	1863	1863	1863		
Adj Flow Rate, veh/h	168	187	315	120	592	603		
Adj No. of Lanes	1	1	1	1	1	1		
Peak Hour Factor	0.91	0.91	0.91	0.91	0.91	0.91		
Percent Heavy Veh, %	2	2	2	2	2	2		
Cap, veh/h	242	543	366	1342	824	700		
Arrive On Green	0.14	0.14	0.21	0.72	0.44	0.44		
Sat Flow, veh/h	1774	1583	1774	1863	1863	1583		
Grp Volume(v), veh/h	168	187	315	120	592	603		
Grp Sat Flow(s),veh/h/ln	1774	1583	1774	1863	1863	1583		
Q Serve(g_s), s	5.0	4.9	9.6	1.1	14.5	19.2		
Cycle Q Clear(g_c), s	5.0	4.9	9.6	1.1	14.5	19.2		
Prop In Lane	1.00	1.00	1.00			1.00		
Lane Grp Cap(c), veh/h	242	543	366	1342	824	700		
V/C Ratio(X)	0.69	0.34	0.86	0.09	0.72	0.86		
Avail Cap(c_a), veh/h	413	695	381	1468	934	794		
HCM Platoon Ratio	1.00	1.00	1.00	1.00	1.00	1.00		
Upstream Filter(I)	1.00	1.00	1.00	1.00	1.00	1.00		
Uniform Delay (d), s/veh	23.0	13.7	21.4	2.3	12.7	14.0		
Incr Delay (d2), s/veh	3.6	0.4	17.2	0.0	2.3	8.7		
Initial Q Delay(d3),s/veh	0.0	0.0	0.0	0.0	0.0	0.0		
%ile BackOfQ(50%),veh/ln	2.7	4.8	6.4	0.5	7.9	9.9		
LnGrp Delay(d),s/veh	26.6	14.0	38.6	2.4	15.1	22.7		
LnGrp LOS	C	B	D	A	B	C		
Approach Vol, veh/h	355			435	1195			
Approach Delay, s/veh	20.0			28.6	18.9			
Approach LOS	B			C	B			
Timer	1	2	3	4	5	6	7	8
Assigned Phs	2		4		5	6		
Phs Duration (G+Y+Rc), s	44.2		11.6		15.5	28.7		
Change Period (Y+Rc), s	4.0		4.0		4.0	4.0		
Max Green Setting (Gmax), s	44.0		13.0		12.0	28.0		
Max Q Clear Time (g_c+I1), s	3.1		7.0		11.6	21.2		
Green Ext Time (p_c), s	0.7		0.6		0.1	3.5		
Intersection Summary								
HCM 2010 Ctrl Delay			21.2					
HCM 2010 LOS			C					

Intersection												
Int Delay, s/veh	3.2											
Movement	EBL	EBT	EBR	WBL	WBT	WBR	NBL	NBT	NBR	SBL	SBT	SBR
Lane Configurations		↕			↕			↕			↕	
Traffic Vol, veh/h	11	0	5	3	1	2	5	17	4	2	25	3
Future Vol, veh/h	11	0	5	3	1	2	5	17	4	2	25	3
Conflicting Peds, #/hr	0	0	0	0	0	0	0	0	0	0	0	0
Sign Control	Stop	Stop	Stop	Stop	Stop	Stop	Free	Free	Free	Free	Free	Free
RT Channelized	-	-	None	-	-	None	-	-	None	-	-	None
Storage Length	-	-	-	-	-	-	-	-	-	-	-	-
Veh in Median Storage, #	-	0	-	-	0	-	-	0	-	-	0	-
Grade, %	-	0	-	-	0	-	-	0	-	-	0	-
Peak Hour Factor	86	86	86	86	86	86	86	86	86	86	86	86
Heavy Vehicles, %	2	2	2	2	2	2	2	2	2	2	2	2
Mvmt Flow	13	0	6	3	1	2	6	20	5	2	29	3

Major/Minor	Minor2		Minor1		Major1			Major2				
Conflicting Flow All	71	72	31	73	71	23	32	0	0	25	0	0
Stage 1	35	35	-	35	35	-	-	-	-	-	-	-
Stage 2	36	37	-	38	36	-	-	-	-	-	-	-
Critical Hdwy	7.12	6.52	6.22	7.12	6.52	6.22	4.12	-	-	4.12	-	-
Critical Hdwy Stg 1	6.12	5.52	-	6.12	5.52	-	-	-	-	-	-	-
Critical Hdwy Stg 2	6.12	5.52	-	6.12	5.52	-	-	-	-	-	-	-
Follow-up Hdwy	3.518	4.018	3.318	3.518	4.018	3.318	2.218	-	-	2.218	-	-
Pot Cap-1 Maneuver	920	818	1043	918	819	1054	1580	-	-	1589	-	-
Stage 1	981	866	-	981	866	-	-	-	-	-	-	-
Stage 2	980	864	-	977	865	-	-	-	-	-	-	-
Platoon blocked, %								-	-	-	-	-
Mov Cap-1 Maneuver	914	814	1043	910	815	1054	1580	-	-	1589	-	-
Mov Cap-2 Maneuver	914	814	-	910	815	-	-	-	-	-	-	-
Stage 1	977	865	-	977	863	-	-	-	-	-	-	-
Stage 2	973	861	-	971	864	-	-	-	-	-	-	-

Approach	EB		WB		NB		SB	
HCM Control Delay, s	8.9		8.9		1.4		0.5	
HCM LOS	A		A					

Minor Lane/Major Mvmt	NBL	NBT	NBR	EBLn1WBLn1	SBL	SBT	SBR
Capacity (veh/h)	1580	-	-	951	934	1589	-
HCM Lane V/C Ratio	0.004	-	-	0.02	0.007	0.001	-
HCM Control Delay (s)	7.3	0	-	8.9	8.9	7.3	0
HCM Lane LOS	A	A	-	A	A	A	A
HCM 95th %tile Q(veh)	0	-	-	0.1	0	0	-

Intersection						
Int Delay, s/veh	5.2					
Movement	WBL	WBR	NBT	NBR	SBL	SBT
Lane Configurations	W		T			T
Traffic Vol, veh/h	63	13	13	30	28	34
Future Vol, veh/h	63	13	13	30	28	34
Conflicting Peds, #/hr	0	0	0	0	0	0
Sign Control	Stop	Stop	Free	Free	Free	Free
RT Channelized	-	None	-	None	-	None
Storage Length	0	-	-	-	-	-
Veh in Median Storage, #	0	-	0	-	-	0
Grade, %	0	-	0	-	-	0
Peak Hour Factor	86	86	86	86	86	86
Heavy Vehicles, %	2	2	2	2	2	2
Mvmt Flow	73	15	15	35	33	40

Major/Minor	Minor1	Major1	Major2			
Conflicting Flow All	139	33	0	0	50	0
Stage 1	33	-	-	-	-	-
Stage 2	106	-	-	-	-	-
Critical Hdwy	6.42	6.22	-	-	4.12	-
Critical Hdwy Stg 1	5.42	-	-	-	-	-
Critical Hdwy Stg 2	5.42	-	-	-	-	-
Follow-up Hdwy	3.518	3.318	-	-	2.218	-
Pot Cap-1 Maneuver	854	1041	-	-	1557	-
Stage 1	989	-	-	-	-	-
Stage 2	918	-	-	-	-	-
Platoon blocked, %			-	-		-
Mov Cap-1 Maneuver	835	1041	-	-	1557	-
Mov Cap-2 Maneuver	835	-	-	-	-	-
Stage 1	967	-	-	-	-	-
Stage 2	918	-	-	-	-	-

Approach	WB	NB	SB
HCM Control Delay, s	9.6	0	3.3
HCM LOS	A		

Minor Lane/Major Mvmt	NBT	NBRWBLn1	SBL	SBT
Capacity (veh/h)	-	-	864	1557
HCM Lane V/C Ratio	-	-	0.102	0.021
HCM Control Delay (s)	-	-	9.6	7.4
HCM Lane LOS	-	-	A	A
HCM 95th %tile Q(veh)	-	-	0.3	0.1

Intersection						
Int Delay, s/veh	3					
Movement	EBL	EBR	NBL	NBT	SBT	SBR
Lane Configurations	T			T		T
Traffic Vol, veh/h	8	58	25	54	88	41
Future Vol, veh/h	8	58	25	54	88	41
Conflicting Peds, #/hr	0	0	0	0	0	0
Sign Control	Stop	Stop	Free	Free	Free	Free
RT Channelized	-	None	-	None	-	None
Storage Length	0	-	-	-	-	-
Veh in Median Storage, #	0	-	-	0	0	-
Grade, %	0	-	-	0	0	-
Peak Hour Factor	85	85	85	85	85	85
Heavy Vehicles, %	2	2	2	2	2	2
Mvmt Flow	9	68	29	64	104	48

Major/Minor	Minor2	Major1		Major2	
Conflicting Flow All	250	128	152	0	0
Stage 1	128	-	-	-	-
Stage 2	122	-	-	-	-
Critical Hdwy	6.42	6.22	4.12	-	-
Critical Hdwy Stg 1	5.42	-	-	-	-
Critical Hdwy Stg 2	5.42	-	-	-	-
Follow-up Hdwy	3.518	3.318	2.218	-	-
Pot Cap-1 Maneuver	739	922	1429	-	-
Stage 1	898	-	-	-	-
Stage 2	903	-	-	-	-
Platoon blocked, %				-	-
Mov Cap-1 Maneuver	723	922	1429	-	-
Mov Cap-2 Maneuver	723	-	-	-	-
Stage 1	879	-	-	-	-
Stage 2	903	-	-	-	-

Approach	EB	NB	SB
HCM Control Delay, s	9.4	2.4	0
HCM LOS	A		

Minor Lane/Major Mvmt	NBL	NBT	EBLn1	SBT	SBR
Capacity (veh/h)	1429	-	892	-	-
HCM Lane V/C Ratio	0.021	-	0.087	-	-
HCM Control Delay (s)	7.6	0	9.4	-	-
HCM Lane LOS	A	A	A	-	-
HCM 95th %tile Q(veh)	0.1	-	0.3	-	-

Intersection						
Int Delay, s/veh	7.7					
Movement	EBL	EBT	WBT	WBR	SBL	SBR
Lane Configurations	↘	↑	↑	↗	↘	↘
Traffic Vol, veh/h	71	156	263	152	189	90
Future Vol, veh/h	71	156	263	152	189	90
Conflicting Peds, #/hr	0	0	0	0	0	0
Sign Control	Free	Free	Free	Free	Stop	Stop
RT Channelized	-	None	-	None	-	None
Storage Length	165	-	-	80	0	-
Veh in Median Storage, #	-	0	0	-	0	-
Grade, %	-	0	0	-	0	-
Peak Hour Factor	92	92	92	92	92	92
Heavy Vehicles, %	2	2	2	2	2	2
Mvmt Flow	77	170	286	165	205	98























Major/Minor	Major1	Major2	Minor2		
Conflicting Flow All	451	0	-	0	610 286
Stage 1	-	-	-	-	286 -
Stage 2	-	-	-	-	324 -
Critical Hdwy	4.12	-	-	-	6.42 6.22
Critical Hdwy Stg 1	-	-	-	-	5.42 -
Critical Hdwy Stg 2	-	-	-	-	5.42 -
Follow-up Hdwy	2.218	-	-	-	3.518 3.318
Pot Cap-1 Maneuver	1109	-	-	-	458 753
Stage 1	-	-	-	-	763 -
Stage 2	-	-	-	-	733 -
Platoon blocked, %		-	-	-	
Mov Cap-1 Maneuver	1109	-	-	-	426 753
Mov Cap-2 Maneuver	-	-	-	-	426 -
Stage 1	-	-	-	-	710 -
Stage 2	-	-	-	-	733 -

Approach	EB	WB	SB
HCM Control Delay, s	2.7	0	23.1
HCM LOS			C

Minor Lane/Major Mvmt	EBL	EBT	WBT	WBR	SBLn1
Capacity (veh/h)	1109	-	-	-	495
HCM Lane V/C Ratio	0.07	-	-	-	0.613
HCM Control Delay (s)	8.5	-	-	-	23.1
HCM Lane LOS	A	-	-	-	C
HCM 95th %tile Q(veh)	0.2	-	-	-	4.1

HCM 2010 Signalized Intersection Summary
 16: SR-76 & Old River Rd/East Vista Way

Existing + Project AM Peak Hour
 07/10/2019

												
Movement	EBL	EBT	EBR	WBL	WBT	WBR	NBL	NBT	NBR	SBL	SBT	SBR
Lane Configurations												
Traffic Volume (veh/h)	7	141	151	254	24	343	68	777	342	543	1480	63
Future Volume (veh/h)	7	141	151	254	24	343	68	777	342	543	1480	63
Number	7	4	14	3	8	18	5	2	12	1	6	16
Initial Q (Qb), veh	0	0	0	0	0	0	0	0	0	0	0	0
Ped-Bike Adj(A_pbT)	1.00		1.00	1.00		1.00	1.00		1.00	1.00		1.00
Parking Bus, Adj	1.00	1.00	1.00	1.00	1.00	1.00	1.00	1.00	1.00	1.00	1.00	1.00
Adj Sat Flow, veh/h/ln	1900	1863	1900	1863	1863	1863	1863	1863	1863	1863	1863	1900
Adj Flow Rate, veh/h	7	147	157	283	0	357	71	809	356	566	1542	66
Adj No. of Lanes	0	2	0	2	0	1	1	3	1	2	3	0
Peak Hour Factor	0.96	0.96	0.96	0.96	0.96	0.96	0.96	0.96	0.96	0.96	0.96	0.96
Percent Heavy Veh, %	2	2	2	2	2	2	2	2	2	2	2	2
Cap, veh/h	10	218	195	729	0	625	123	1469	457	652	2046	88
Arrive On Green	0.12	0.12	0.12	0.21	0.00	0.21	0.07	0.29	0.29	0.19	0.41	0.41
Sat Flow, veh/h	84	1774	1583	3548	0	1583	1774	5085	1583	3442	5001	214
Grp Volume(v), veh/h	154	0	157	283	0	357	71	809	356	566	1045	563
Grp Sat Flow(s),veh/h/ln	1859	0	1583	1774	0	1583	1774	1695	1583	1721	1695	1825
Q Serve(g_s), s	10.7	0.0	13.0	9.3	0.0	23.7	5.2	18.1	27.8	21.5	35.5	35.5
Cycle Q Clear(g_c), s	10.7	0.0	13.0	9.3	0.0	23.7	5.2	18.1	27.8	21.5	35.5	35.5
Prop In Lane	0.05		1.00	1.00		1.00	1.00		1.00	1.00		0.12
Lane Grp Cap(c), veh/h	229	0	195	729	0	625	123	1469	457	652	1387	747
V/C Ratio(X)	0.67	0.00	0.81	0.39	0.00	0.57	0.58	0.55	0.78	0.87	0.75	0.75
Avail Cap(c_a), veh/h	414	0	353	1002	0	747	395	3324	1035	1074	2191	1179
HCM Platoon Ratio	1.00	1.00	1.00	1.00	1.00	1.00	1.00	1.00	1.00	1.00	1.00	1.00
Upstream Filter(I)	1.00	0.00	1.00	1.00	0.00	1.00	1.00	1.00	1.00	1.00	1.00	1.00
Uniform Delay (d), s/veh	56.4	0.0	57.4	46.2	0.0	31.8	60.8	40.5	43.9	52.9	34.0	34.0
Incr Delay (d2), s/veh	3.4	0.0	7.6	0.3	0.0	0.8	4.3	0.3	2.9	4.4	0.9	1.6
Initial Q Delay(d3),s/veh	0.0	0.0	0.0	0.0	0.0	0.0	0.0	0.0	0.0	0.0	0.0	0.0
%ile BackOfQ(50%),veh/ln	5.7	0.0	6.1	4.6	0.0	10.5	2.7	8.5	12.5	10.6	16.7	18.1
LnGrp Delay(d),s/veh	59.8	0.0	65.0	46.5	0.0	32.6	65.0	40.8	46.8	57.3	34.8	35.5
LnGrp LOS	E		E	D		C	E	D	D	E	C	D
Approach Vol, veh/h		311			640			1236			2174	
Approach Delay, s/veh		62.5			38.8			43.9			40.9	
Approach LOS		E			D			D			D	
Timer	1	2	3	4	5	6	7	8				
Assigned Phs	1	2		4	5	6		8				
Phs Duration (G+Y+Rc), s	31.2	46.4		23.0	15.0	62.6		34.1				
Change Period (Y+Rc), s	* 5.7	7.5		6.4	* 5.7	7.5		6.4				
Max Green Setting (Gmax), s	* 42	88.0		30.0	* 30	87.0		38.0				
Max Q Clear Time (g_c+I1), s	23.5	29.8		15.0	7.2	37.5		25.7				
Green Ext Time (p_c), s	2.0	8.9		1.6	0.1	17.6		1.9				
Intersection Summary												
HCM 2010 Ctrl Delay				43.0								
HCM 2010 LOS				D								
Notes												

HCM 2010 Signalized Intersection Summary
 17: SR-76 & N River Rd

Existing + Project AM Peak Hour
 07/10/2019



Movement	EBL	EBR	NBL	NBT	SBT	SBR		
Lane Configurations								
Traffic Volume (veh/h)	181	143	138	1086	1909	546		
Future Volume (veh/h)	181	143	138	1086	1909	546		
Number	7	14	5	2	6	16		
Initial Q (Qb), veh	0	0	0	0	0	0		
Ped-Bike Adj(A_pbT)	1.00	1.00	1.00			1.00		
Parking Bus, Adj	1.00	1.00	1.00	1.00	1.00	1.00		
Adj Sat Flow, veh/h/ln	1863	1863	1863	1863	1863	1863		
Adj Flow Rate, veh/h	191	151	145	1143	2009	575		
Adj No. of Lanes	1	1	1	2	2	1		
Peak Hour Factor	0.95	0.95	0.95	0.95	0.95	0.95		
Percent Heavy Veh, %	2	2	2	2	2	2		
Cap, veh/h	221	197	168	2801	2341	1047		
Arrive On Green	0.12	0.12	0.09	0.79	0.66	0.66		
Sat Flow, veh/h	1774	1583	1774	3632	3632	1583		
Grp Volume(v), veh/h	191	151	145	1143	2009	575		
Grp Sat Flow(s),veh/h/ln	1774	1583	1774	1770	1770	1583		
Q Serve(g_s), s	17.0	14.9	13.0	16.1	71.7	31.2		
Cycle Q Clear(g_c), s	17.0	14.9	13.0	16.1	71.7	31.2		
Prop In Lane	1.00	1.00	1.00			1.00		
Lane Grp Cap(c), veh/h	221	197	168	2801	2341	1047		
V/C Ratio(X)	0.87	0.77	0.86	0.41	0.86	0.55		
Avail Cap(c_a), veh/h	440	392	319	2801	2632	1177		
HCM Platoon Ratio	1.00	1.00	1.00	1.00	1.00	1.00		
Upstream Filter(I)	1.00	1.00	1.00	1.00	1.00	1.00		
Uniform Delay (d), s/veh	69.3	68.4	72.0	5.2	21.4	14.5		
Incr Delay (d2), s/veh	9.8	6.1	12.2	0.1	2.8	0.5		
Initial Q Delay(d3),s/veh	0.0	0.0	0.0	0.0	0.0	0.0		
%ile BackOfQ(50%),veh/ln	9.0	13.0	7.0	7.8	35.8	13.7		
LnGrp Delay(d),s/veh	79.1	74.5	84.2	5.3	24.2	15.0		
LnGrp LOS	E	E	F	A	C	B		
Approach Vol, veh/h	342			1288	2584			
Approach Delay, s/veh	77.1			14.2	22.2			
Approach LOS	E			B	C			
Timer	1	2	3	4	5	6	7	8
Assigned Phs		2		4	5	6		
Phs Duration (G+Y+Rc), s		135.2		26.2	21.0	114.2		
Change Period (Y+Rc), s		7.5		6.1	* 5.7	7.5		
Max Green Setting (Gmax), s		85.0		40.0	* 29	120.0		
Max Q Clear Time (g_c+I1), s		18.1		19.0	15.0	73.7		
Green Ext Time (p_c), s		11.9		1.0	0.3	33.0		
Intersection Summary								
HCM 2010 Ctrl Delay			24.2					
HCM 2010 LOS			C					
Notes								

HCM 2010 Signalized Intersection Summary
 18: SR-76 & Via Montellano

Existing + Project AM Peak Hour
 07/10/2019



Movement	EBL	EBR	NBL	NBT	SBT	SBR		
Lane Configurations	↘		↙	↑↑	↑↑	↗		
Traffic Volume (veh/h)	8	7	3	1316	2421	9		
Future Volume (veh/h)	8	7	3	1316	2421	9		
Number	7	14	5	2	6	16		
Initial Q (Qb), veh	0	0	0	0	0	0		
Ped-Bike Adj(A_pbT)	1.00	1.00	1.00			1.00		
Parking Bus, Adj	1.00	1.00	1.00	1.00	1.00	1.00		
Adj Sat Flow, veh/h/ln	1863	1900	1863	1863	1863	1863		
Adj Flow Rate, veh/h	8	7	3	1343	2470	9		
Adj No. of Lanes	0	0	1	2	2	1		
Peak Hour Factor	0.98	0.98	0.98	0.98	0.98	0.98		
Percent Heavy Veh, %	0	0	2	2	2	2		
Cap, veh/h	30	26	13	2963	2748	1229		
Arrive On Green	0.04	0.04	0.01	0.84	0.78	0.78		
Sat Flow, veh/h	845	739	1774	3632	3632	1583		
Grp Volume(v), veh/h	16	0	3	1343	2470	9		
Grp Sat Flow(s),veh/h/ln	1690	0	1774	1770	1770	1583		
Q Serve(g_s), s	1.0	0.0	0.2	10.6	55.1	0.1		
Cycle Q Clear(g_c), s	1.0	0.0	0.2	10.6	55.1	0.1		
Prop In Lane	0.50	0.44	1.00			1.00		
Lane Grp Cap(c), veh/h	60	0	13	2963	2748	1229		
V/C Ratio(X)	0.27	0.00	0.24	0.45	0.90	0.01		
Avail Cap(c_a), veh/h	539	0	399	2963	2887	1291		
HCM Platoon Ratio	1.00	1.00	1.00	1.00	1.00	1.00		
Upstream Filter(I)	1.00	0.00	1.00	1.00	1.00	1.00		
Uniform Delay (d), s/veh	50.1	0.0	52.7	2.3	8.8	2.7		
Incr Delay (d2), s/veh	2.4	0.0	9.2	0.1	4.1	0.0		
Initial Q Delay(d3),s/veh	0.0	0.0	0.0	0.0	0.0	0.0		
%ile BackOfQ(50%),veh/ln	0.5	0.0	0.1	5.1	27.6	0.1		
LnGrp Delay(d),s/veh	52.5	0.0	61.8	2.4	12.9	2.7		
LnGrp LOS	D		E	A	B	A		
Approach Vol, veh/h	16			1346	2479			
Approach Delay, s/veh	52.5			2.5	12.9			
Approach LOS	D			A	B			
Timer	1	2	3	4	5	6	7	8
Assigned Phs		2		4	5	6		
Phs Duration (G+Y+Rc), s		96.8		9.9	6.5	90.3		
Change Period (Y+Rc), s		7.5		6.1	* 5.7	7.5		
Max Green Setting (Gmax), s		85.0		34.0	* 24	87.0		
Max Q Clear Time (g_c+I1), s		12.6		3.0	2.2	57.1		
Green Ext Time (p_c), s		15.9		0.0	0.0	25.7		
Intersection Summary								
HCM 2010 Ctrl Delay			9.4					
HCM 2010 LOS			A					
Notes								

HCM 2010 Signalized Intersection Summary
 19: I-15 SB Ramps & Highway 76

Existing + Project AM Peak Hour
 07/10/2019



Movement	EBL	EBT	EBR	WBL	WBT	WBR	NBL	NBT	NBR	SBL	SBT	SBR
Lane Configurations		↑↑↑	↑		↑↑	↑				↑	↔	↑
Traffic Volume (veh/h)	0	747	152	0	418	119	0	0	0	48	0	1348
Future Volume (veh/h)	0	747	152	0	418	119	0	0	0	48	0	1348
Number	5	2	12	1	6	16				7	4	14
Initial Q (Qb), veh	0	0	0	0	0	0				0	0	0
Ped-Bike Adj(A_pbT)	1.00		1.00	1.00		1.00				1.00		1.00
Parking Bus, Adj	1.00	1.00	1.00	1.00	1.00	1.00				1.00	1.00	1.00
Adj Sat Flow, veh/h/ln	0	1863	1863	0	1863	1863				1863	1863	1863
Adj Flow Rate, veh/h	0	821	167	0	459	131				35	0	1500
Adj No. of Lanes	0	3	1	0	2	1				1	0	2
Peak Hour Factor	0.91	0.91	0.91	0.91	0.91	0.91				0.91	0.91	0.91
Percent Heavy Veh, %	0	2	2	0	2	2				2	2	2
Cap, veh/h	0	1386	431	0	964	1289				961	0	1716
Arrive On Green	0.00	0.27	0.27	0.00	0.27	0.27				0.54	0.00	0.54
Sat Flow, veh/h	0	5253	1583	0	3632	1583				1774	0	3167
Grp Volume(v), veh/h	0	821	167	0	459	131				35	0	1500
Grp Sat Flow(s),veh/h/ln	0	1695	1583	0	1770	1583				1774	0	1583
Q Serve(g_s), s	0.0	10.3	6.3	0.0	7.9	1.2				0.7	0.0	30.2
Cycle Q Clear(g_c), s	0.0	10.3	6.3	0.0	7.9	1.2				0.7	0.0	30.2
Prop In Lane	0.00		1.00	0.00		1.00				1.00		1.00
Lane Grp Cap(c), veh/h	0	1386	431	0	964	1289				961	0	1716
V/C Ratio(X)	0.00	0.59	0.39	0.00	0.48	0.10				0.04	0.00	0.87
Avail Cap(c_a), veh/h	0	3817	1189	0	2802	2111				1211	0	2161
HCM Platoon Ratio	1.00	1.00	1.00	1.00	1.00	1.00				1.00	1.00	1.00
Upstream Filter(I)	0.00	1.00	1.00	0.00	1.00	1.00				1.00	0.00	1.00
Uniform Delay (d), s/veh	0.0	23.1	21.7	0.0	22.3	1.4				7.8	0.0	14.6
Incr Delay (d2), s/veh	0.0	0.4	0.6	0.0	0.4	0.0				0.0	0.0	3.6
Initial Q Delay(d3),s/veh	0.0	0.0	0.0	0.0	0.0	0.0				0.0	0.0	0.0
%ile BackOfQ(50%),veh/ln	0.0	4.8	2.8	0.0	3.9	2.1				0.3	0.0	13.8
LnGrp Delay(d),s/veh	0.0	23.5	22.2	0.0	22.6	1.4				7.9	0.0	18.2
LnGrp LOS		C	C		C	A				A		B
Approach Vol, veh/h		988			590						1535	
Approach Delay, s/veh		23.3			17.9						17.9	
Approach LOS		C			B						B	
Timer	1	2	3	4	5	6	7	8				
Assigned Phs		2		4		6						
Phs Duration (G+Y+Rc), s		27.5		45.8		27.5						
Change Period (Y+Rc), s		7.5		6.1		7.5						
Max Green Setting (Gmax), s		55.0		50.0		58.0						
Max Q Clear Time (g_c+I1), s		12.3		32.2		9.9						
Green Ext Time (p_c), s		7.7		7.5		3.9						
Intersection Summary												
HCM 2010 Ctrl Delay				19.6								
HCM 2010 LOS				B								
Notes												

HCM 2010 Signalized Intersection Summary
 20: I-15 NB Ramps & Highway 76

Existing + Project AM Peak Hour
 07/10/2019



























Movement	EBL	EBT	EBR	WBL	WBT	WBR	NBL	NBT	NBR	SBL	SBT	SBR
Lane Configurations		↑↑	↑		↑↑↑	↑	↑	↑	↑			
Traffic Volume (veh/h)	0	222	628	0	359	61	162	0	105	0	0	0
Future Volume (veh/h)	0	222	628	0	359	61	162	0	105	0	0	0
Number	5	2	12	1	6	16	3	8	18			
Initial Q (Qb), veh	0	0	0	0	0	0	0	0	0			
Ped-Bike Adj(A_pbT)	1.00		1.00	1.00		1.00	1.00		1.00			
Parking Bus, Adj	1.00	1.00	1.00	1.00	1.00	1.00	1.00	1.00	1.00			
Adj Sat Flow, veh/h/ln	0	1863	1863	0	1863	1863	1863	1863	1863			
Adj Flow Rate, veh/h	0	231	654	0	374	64	203	0	73			
Adj No. of Lanes	0	2	1	0	3	1	2	0	1			
Peak Hour Factor	0.96	0.96	0.96	0.96	0.96	0.96	0.96	0.96	0.96			
Percent Heavy Veh, %	0	2	2	0	2	2	2	2	2			
Cap, veh/h	0	1648	965	0	2368	737	510	0	227			
Arrive On Green	0.00	0.47	0.47	0.00	0.47	0.47	0.14	0.00	0.14			
Sat Flow, veh/h	0	3632	1583	0	5253	1583	3548	0	1583			
Grp Volume(v), veh/h	0	231	654	0	374	64	203	0	73			
Grp Sat Flow(s),veh/h/ln	0	1770	1583	0	1695	1583	1774	0	1583			
Q Serve(g_s), s	0.0	1.3	9.6	0.0	1.5	0.8	1.8	0.0	1.4			
Cycle Q Clear(g_c), s	0.0	1.3	9.6	0.0	1.5	0.8	1.8	0.0	1.4			
Prop In Lane	0.00		1.00	0.00		1.00	1.00		1.00			
Lane Grp Cap(c), veh/h	0	1648	965	0	2368	737	510	0	227			
V/C Ratio(X)	0.00	0.14	0.68	0.00	0.16	0.09	0.40	0.00	0.32			
Avail Cap(c_a), veh/h	0	5186	2547	0	5259	1638	4485	0	2001			
HCM Platoon Ratio	1.00	1.00	1.00	1.00	1.00	1.00	1.00	1.00	1.00			
Upstream Filter(I)	0.00	1.00	1.00	0.00	1.00	1.00	1.00	0.00	1.00			
Uniform Delay (d), s/veh	0.0	5.3	4.5	0.0	5.4	5.2	13.5	0.0	13.4			
Incr Delay (d2), s/veh	0.0	0.0	0.8	0.0	0.0	0.1	0.5	0.0	0.8			
Initial Q Delay(d3),s/veh	0.0	0.0	0.0	0.0	0.0	0.0	0.0	0.0	0.0			
%ile BackOfQ(50%),veh/ln	0.0	0.6	5.9	0.0	0.7	0.3	0.9	0.0	0.7			
LnGrp Delay(d),s/veh	0.0	5.4	5.4	0.0	5.4	5.2	14.0	0.0	14.2			
LnGrp LOS		A	A		A	A	B		B			
Approach Vol, veh/h		885			438			276				
Approach Delay, s/veh		5.4			5.4			14.1				
Approach LOS		A			A			B				
Timer	1	2	3	4	5	6	7	8				
Assigned Phs		2				6		8				
Phs Duration (G+Y+Rc), s		23.7				23.7		11.1				
Change Period (Y+Rc), s		7.5				7.5		6.1				
Max Green Setting (Gmax), s		51.0				36.0		44.0				
Max Q Clear Time (g_c+I1), s		11.6				3.5		3.8				
Green Ext Time (p_c), s		4.6				2.9		1.0				
Intersection Summary												
HCM 2010 Ctrl Delay			6.9									
HCM 2010 LOS			A									
Notes												

HCM 2010 Signalized Intersection Summary
 1: Highway 76 & Olive Hill Road/Camino Del Rey

Existing + Project PM Peak Hour

07/10/2019

												
Movement	EBL	EBT	EBR	WBL	WBT	WBR	NBL	NBT	NBR	SBL	SBT	SBR
Lane Configurations												
Traffic Volume (veh/h)	112	60	123	160	118	302	139	2263	198	228	1322	49
Future Volume (veh/h)	112	60	123	160	118	302	139	2263	198	228	1322	49
Number	7	4	14	3	8	18	5	2	12	1	6	16
Initial Q (Qb), veh	0	0	0	0	0	0	0	0	0	0	0	0
Ped-Bike Adj(A_pbT)	1.00		1.00	1.00		1.00	1.00		1.00	1.00		1.00
Parking Bus, Adj	1.00	1.00	1.00	1.00	1.00	1.00	1.00	1.00	1.00	1.00	1.00	1.00
Adj Sat Flow, veh/h/ln	1863	1863	1863	1863	1863	1863	1863	1863	1863	1863	1863	1863
Adj Flow Rate, veh/h	114	61	126	163	120	308	142	2309	202	233	1349	50
Adj No. of Lanes	2	1	1	1	1	1	1	3	1	2	3	1
Peak Hour Factor	0.98	0.98	0.98	0.98	0.98	0.98	0.98	0.98	0.98	0.98	0.98	0.98
Percent Heavy Veh, %	2	2	2	2	2	2	2	2	2	2	2	2
Cap, veh/h	319	173	147	376	395	336	162	2434	758	278	2380	741
Arrive On Green	0.09	0.09	0.09	0.21	0.21	0.21	0.09	0.48	0.48	0.08	0.47	0.47
Sat Flow, veh/h	3442	1863	1583	1774	1863	1583	1774	5085	1583	3442	5085	1583
Grp Volume(v), veh/h	114	61	126	163	120	308	142	2309	202	233	1349	50
Grp Sat Flow(s),veh/h/ln	1721	1863	1583	1774	1863	1583	1774	1695	1583	1721	1695	1583
Q Serve(g_s), s	5.8	5.7	14.7	14.9	10.1	35.6	14.8	81.1	14.3	12.5	35.9	3.2
Cycle Q Clear(g_c), s	5.8	5.7	14.7	14.9	10.1	35.6	14.8	81.1	14.3	12.5	35.9	3.2
Prop In Lane	1.00		1.00	1.00		1.00	1.00		1.00	1.00		1.00
Lane Grp Cap(c), veh/h	319	173	147	376	395	336	162	2434	758	278	2380	741
V/C Ratio(X)	0.36	0.35	0.86	0.43	0.30	0.92	0.88	0.95	0.27	0.84	0.57	0.07
Avail Cap(c_a), veh/h	442	239	203	503	528	449	285	2448	762	497	2448	762
HCM Platoon Ratio	1.00	1.00	1.00	1.00	1.00	1.00	1.00	1.00	1.00	1.00	1.00	1.00
Upstream Filter(I)	1.00	1.00	1.00	1.00	1.00	1.00	1.00	1.00	1.00	1.00	1.00	1.00
Uniform Delay (d), s/veh	79.6	79.6	83.6	63.9	62.0	72.0	83.9	46.6	29.1	84.7	36.0	27.3
Incr Delay (d2), s/veh	0.7	1.2	22.3	0.8	0.4	19.6	13.8	9.0	0.2	6.7	0.3	0.0
Initial Q Delay(d3),s/veh	0.0	0.0	0.0	0.0	0.0	0.0	0.0	0.0	0.0	0.0	0.0	0.0
%ile BackOfQ(50%),veh/ln	2.8	3.0	7.3	7.4	5.3	17.4	7.9	39.9	6.3	6.2	16.9	1.4
LnGrp Delay(d),s/veh	80.3	80.8	105.9	64.7	62.4	91.7	97.7	55.6	29.3	91.4	36.3	27.4
LnGrp LOS	F	F	F	E	E	F	F	E	C	F	D	C
Approach Vol, veh/h		301			591			2653			1632	
Approach Delay, s/veh		91.1			78.3			55.8			43.9	
Approach LOS		F			E			E			D	
Timer	1	2	3	4	5	6	7	8				
Assigned Phs	1	2		4	5	6		8				
Phs Duration (G+Y+Rc), s	20.8	97.0		23.4	22.8	95.0		45.8				
Change Period (Y+Rc), s	* 5.7	7.5		6.1	* 5.7	7.5		6.1				
Max Green Setting (Gmax), s	* 27	90.0		24.0	* 30	90.0		53.0				
Max Q Clear Time (g_c+I1), s	14.5	83.1		16.7	16.8	37.9		37.6				
Green Ext Time (p_c), s	0.6	6.4		0.7	0.3	14.7		2.1				
Intersection Summary												
HCM 2010 Ctrl Delay			56.7									
HCM 2010 LOS			E									
Notes												

Intersection						
Int Delay, s/veh	0					
Movement	EBL	EBR	NBL	NBT	SBT	SBR
Lane Configurations	↔		↔	↑	↑	↔
Traffic Vol, veh/h	390	79	92	68	55	508
Future Vol, veh/h	390	79	92	68	55	508
Conflicting Peds, #/hr	0	0	0	0	0	0
Sign Control	Free	Free	Stop	Stop	Free	Free
RT Channelized	-	Free	-	None	-	Free
Storage Length	0	-	150	-	-	150
Veh in Median Storage, #	-	-	-	0	0	-
Grade, %	0	-	-	0	0	-
Peak Hour Factor	97	97	97	97	97	97
Heavy Vehicles, %	2	2	2	2	2	2
Mvmt Flow	402	81	95	70	57	524

Major/Minor	Minor2	Major2		
Conflicting Flow All	57	57	-	0
Stage 1	57	57	-	-
Stage 2	0	0	-	-
Critical Hdwy	6.42	6.52	-	-
Critical Hdwy Stg 1	5.42	5.52	-	-
Critical Hdwy Stg 2	-	-	-	-
Follow-up Hdwy	3.518	4.018	-	-
Pot Cap-1 Maneuver	950	834	-	0
Stage 1	966	847	-	0
Stage 2	-	-	-	0
Platoon blocked, %			-	
Mov Cap-1 Maneuver	950	0	-	-
Mov Cap-2 Maneuver	950	0	-	-
Stage 1	966	0	-	-
Stage 2	-	0	-	-

Approach	NB	SB
HCM Control Delay, s		0
HCM LOS	-	

Minor Lane/Major Mvmt	NBLn1	NBLn2	SBT
Capacity (veh/h)	950	-	-
HCM Lane V/C Ratio	0.1	-	-
HCM Control Delay (s)	9.2	-	-
HCM Lane LOS	A	-	-
HCM 95th %tile Q(veh)	0.3	-	-

Intersection						
Int Delay, s/veh	3.8					
Movement	EBL	EBT	WBT	WBR	SBL	SBR
Lane Configurations		↔	↔		↔	↔
Traffic Vol, veh/h	197	264	451	27	8	144
Future Vol, veh/h	197	264	451	27	8	144
Conflicting Peds, #/hr	0	0	0	0	0	0
Sign Control	Free	Free	Free	Free	Stop	Stop
RT Channelized	-	None	-	None	-	Stop
Storage Length	-	-	-	-	0	100
Veh in Median Storage, #	-	0	0	-	0	-
Grade, %	-	0	0	-	0	-
Peak Hour Factor	91	91	91	91	91	91
Heavy Vehicles, %	2	2	2	2	2	2
Mvmt Flow	216	290	496	30	9	158

Major/Minor	Major1	Major2	Minor2		
Conflicting Flow All	526	0	-	0	1233 511
Stage 1	-	-	-	-	511 -
Stage 2	-	-	-	-	722 -
Critical Hdwy	4.12	-	-	-	6.42 6.22
Critical Hdwy Stg 1	-	-	-	-	5.42 -
Critical Hdwy Stg 2	-	-	-	-	5.42 -
Follow-up Hdwy	2.218	-	-	-	3.518 3.318
Pot Cap-1 Maneuver	1041	-	-	-	195 563
Stage 1	-	-	-	-	602 -
Stage 2	-	-	-	-	481 -
Platoon blocked, %		-	-	-	
Mov Cap-1 Maneuver	1041	-	-	-	147 563
Mov Cap-2 Maneuver	-	-	-	-	147 -
Stage 1	-	-	-	-	453 -
Stage 2	-	-	-	-	481 -

























Approach	EB	WB	SB
HCM Control Delay, s	4	0	14.8
HCM LOS			B

Minor Lane/Major Mvmt	EBL	EBT	WBT	WBR	SBLn1	SBLn2
Capacity (veh/h)	1041	-	-	-	147	563
HCM Lane V/C Ratio	0.208	-	-	-	0.06	0.281
HCM Control Delay (s)	9.4	0	-	-	31	13.9
HCM Lane LOS	A	A	-	-	D	B
HCM 95th %tile Q(veh)	0.8	-	-	-	0.2	1.1

HCM 2010 Signalized Intersection Summary
4: Old Highway 395 & Highway 76

Existing + Project PM Peak Hour

07/10/2019

												
Movement	EBL	EBT	EBR	WBL	WBT	WBR	NBL	NBT	NBR	SBL	SBT	SBR
Lane Configurations												
Traffic Volume (veh/h)	155	1077	121	83	868	229	117	164	69	191	79	62
Future Volume (veh/h)	155	1077	121	83	868	229	117	164	69	191	79	62
Number	5	2	12	1	6	16	3	8	18	7	4	14
Initial Q (Qb), veh	0	0	0	0	0	0	0	0	0	0	0	0
Ped-Bike Adj(A_pbT)	1.00		1.00	1.00		1.00	1.00		1.00	1.00		1.00
Parking Bus, Adj	1.00	1.00	1.00	1.00	1.00	1.00	1.00	1.00	1.00	1.00	1.00	1.00
Adj Sat Flow, veh/h/ln	1863	1863	1863	1863	1863	1863	1863	1863	1863	1863	1863	1900
Adj Flow Rate, veh/h	165	1146	26	88	923	0	124	174	-3	203	84	61
Adj No. of Lanes	1	3	1	1	2	1	1	1	1	2	1	0
Peak Hour Factor	0.94	0.94	0.94	0.94	0.94	0.94	0.94	0.94	0.94	0.94	0.94	0.94
Percent Heavy Veh, %	2	2	2	2	2	2	2	2	2	2	2	2
Cap, veh/h	260	1724	537	242	1164	724	195	256	434	442	173	126
Arrive On Green	0.15	0.34	0.34	0.14	0.33	0.00	0.11	0.14	0.00	0.13	0.17	0.17
Sat Flow, veh/h	1774	5085	1583	1774	3539	1583	1774	1863	1583	3442	1005	729
Grp Volume(v), veh/h	165	1146	26	88	923	0	124	174	-3	203	0	145
Grp Sat Flow(s),veh/h/ln	1774	1695	1583	1774	1770	1583	1774	1863	1583	1721	0	1734
Q Serve(g_s), s	9.5	21.0	1.2	4.9	25.8	0.0	7.3	9.7	0.0	6.0	0.0	8.2
Cycle Q Clear(g_c), s	9.5	21.0	1.2	4.9	25.8	0.0	7.3	9.7	0.0	6.0	0.0	8.2
Prop In Lane	1.00		1.00	1.00		1.00	1.00		1.00	1.00		0.42
Lane Grp Cap(c), veh/h	260	1724	537	242	1164	724	195	256	434	442	0	299
V/C Ratio(X)	0.63	0.66	0.05	0.36	0.79	0.00	0.64	0.68	-0.01	0.46	0.00	0.49
Avail Cap(c_a), veh/h	439	2798	871	504	2109	1147	488	564	695	1515	0	1018
HCM Platoon Ratio	1.00	1.00	1.00	1.00	1.00	1.00	1.00	1.00	1.00	1.00	1.00	1.00
Upstream Filter(I)	1.00	1.00	1.00	1.00	1.00	0.00	1.00	1.00	0.00	1.00	0.00	1.00
Uniform Delay (d), s/veh	43.8	30.8	24.2	42.8	33.2	0.0	46.4	44.7	0.0	44.0	0.0	40.8
Incr Delay (d2), s/veh	2.5	0.4	0.0	0.9	1.3	0.0	3.4	3.1	0.0	0.7	0.0	1.2
Initial Q Delay(d3),s/veh	0.0	0.0	0.0	0.0	0.0	0.0	0.0	0.0	0.0	0.0	0.0	0.0
%ile BackOfQ(50%),veh/ln	4.9	9.8	0.5	2.5	12.8	0.0	3.8	5.2	0.0	2.9	0.0	4.0
LnGrp Delay(d),s/veh	46.3	31.2	24.3	43.7	34.5	0.0	49.8	47.9	0.0	44.8	0.0	42.0
LnGrp LOS	D	C	C	D	C		D	D		D		D
Approach Vol, veh/h		1337			1011			295			348	
Approach Delay, s/veh		32.9			35.3			49.2			43.6	
Approach LOS		C			D			D			D	
Timer	1	2	3	4	5	6	7	8				
Assigned Phs	1	2	3	4	5	6	7	8				
Phs Duration (G+Y+Rc), s	20.6	44.5	17.7	26.3	21.7	43.4	21.5	22.5				
Change Period (Y+Rc), s	* 5.7	7.5	* 5.7	7.5	* 5.7	7.5	7.5	* 7.5				
Max Green Setting (Gmax), s	* 31	60.0	* 30	64.0	* 27	65.0	48.0	* 33				
Max Q Clear Time (g_c+I1), s	6.9	23.0	9.3	10.2	11.5	27.8	8.0	11.7				
Green Ext Time (p_c), s	0.2	10.6	0.3	0.9	0.4	8.0	0.7	0.9				
Intersection Summary												
HCM 2010 Ctrl Delay			36.6									
HCM 2010 LOS			D									
Notes												

Intersection						
Int Delay, s/veh	2.7					
Movement	WBL	WBR	NBT	NBR	SBL	SBT
Lane Configurations						
Traffic Vol, veh/h	30	61	257	106	106	178
Future Vol, veh/h	30	61	257	106	106	178
Conflicting Peds, #/hr	0	0	0	0	0	0
Sign Control	Stop	Stop	Free	Free	Free	Free
RT Channelized	-	None	-	None	-	None
Storage Length	0	385	-	-	-	-
Veh in Median Storage, #	0	-	0	-	-	0
Grade, %	0	-	0	-	-	0
Peak Hour Factor	95	95	95	95	95	95
Heavy Vehicles, %	2	2	2	2	2	2
Mvmt Flow	32	64	271	112	112	187

Major/Minor	Minor1	Major1	Major2		
Conflicting Flow All	738	327	0	0	383
Stage 1	327	-	-	-	-
Stage 2	411	-	-	-	-
Critical Hdwy	6.42	6.22	-	-	4.12
Critical Hdwy Stg 1	5.42	-	-	-	-
Critical Hdwy Stg 2	5.42	-	-	-	-
Follow-up Hdwy	3.518	3.318	-	-	2.218
Pot Cap-1 Maneuver	385	714	-	-	1175
Stage 1	731	-	-	-	-
Stage 2	669	-	-	-	-
Platoon blocked, %			-	-	-
Mov Cap-1 Maneuver	344	714	-	-	1175
Mov Cap-2 Maneuver	344	-	-	-	-
Stage 1	654	-	-	-	-
Stage 2	669	-	-	-	-

Approach	WB	NB	SB
HCM Control Delay, s	12.5	0	3.1
HCM LOS	B		

Minor Lane/Major Mvmt	NBT	NBRWBLn1	WBLn2	SBL	SBT
Capacity (veh/h)	-	-	344	714	1175
HCM Lane V/C Ratio	-	-	0.092	0.09	0.095
HCM Control Delay (s)	-	-	16.5	10.5	8.4
HCM Lane LOS	-	-	C	B	A
HCM 95th %tile Q(veh)	-	-	0.3	0.3	0.3

Intersection												
Int Delay, s/veh	6.5											
Movement	EBL	EBT	EBR	WBL	WBT	WBR	NBL	NBT	NBR	SBL	SBT	SBR
Lane Configurations		↖	↗		↖	↗	↖	↗		↖	↗	
Traffic Vol, veh/h	60	14	69	14	14	32	143	272	34	23	102	80
Future Vol, veh/h	60	14	69	14	14	32	143	272	34	23	102	80
Conflicting Peds, #/hr	0	0	0	0	0	0	0	0	0	0	0	0
Sign Control	Stop	Stop	Stop	Stop	Stop	Stop	Free	Free	Free	Free	Free	Free
RT Channelized	-	-	Stop	-	-	Stop	-	-	None	-	-	None
Storage Length	-	-	25	-	-	50	210	-	-	200	-	530
Veh in Median Storage, #	-	0	-	-	0	-	-	0	-	-	0	-
Grade, %	-	0	-	-	0	-	-	0	-	-	0	-
Peak Hour Factor	86	86	86	86	86	86	86	86	86	86	86	86
Heavy Vehicles, %	2	2	2	2	2	2	2	2	2	2	2	2
Mvmt Flow	70	16	80	16	16	37	166	316	40	27	119	93

Major/Minor	Minor2		Minor1		Major1			Major2				
Conflicting Flow All	896	908	106	790	934	336	212	0	0	356	0	0
Stage 1	220	220	-	668	668	-	-	-	-	-	-	-
Stage 2	676	688	-	122	266	-	-	-	-	-	-	-
Critical Hdwy	7.33	6.53	6.93	7.33	6.53	6.23	4.13	-	-	4.13	-	-
Critical Hdwy Stg 1	6.53	5.53	-	6.13	5.53	-	-	-	-	-	-	-
Critical Hdwy Stg 2	6.13	5.53	-	6.53	5.53	-	-	-	-	-	-	-
Follow-up Hdwy	3.519	4.019	3.319	3.519	4.019	3.319	2.219	-	-	2.219	-	-
Pot Cap-1 Maneuver	248	275	928	294	265	705	1357	-	-	1201	-	-
Stage 1	763	721	-	447	455	-	-	-	-	-	-	-
Stage 2	442	446	-	870	688	-	-	-	-	-	-	-
Platoon blocked, %								-	-	-	-	-
Mov Cap-1 Maneuver	198	236	928	227	228	705	1357	-	-	1201	-	-
Mov Cap-2 Maneuver	198	236	-	227	228	-	-	-	-	-	-	-
Stage 1	670	705	-	392	399	-	-	-	-	-	-	-
Stage 2	352	392	-	759	673	-	-	-	-	-	-	-

Approach	EB		WB		NB			SB		
HCM Control Delay, s	22.5		16.5		2.6			0.9		
HCM LOS	C		C							

Minor Lane/Major Mvmt	NBL	NBT	NBR	EBLn1	EBLn2	WBLn1	WBLn2	SBL	SBT	SBR
Capacity (veh/h)	1357	-	-	204	928	227	705	1201	-	-
HCM Lane V/C Ratio	0.123	-	-	0.422	0.086	0.143	0.053	0.022	-	-
HCM Control Delay (s)	8	-	-	34.9	9.2	23.5	10.4	8.1	-	-
HCM Lane LOS	A	-	-	D	A	C	B	A	-	-
HCM 95th %tile Q(veh)	0.4	-	-	1.9	0.3	0.5	0.2	0.1	-	-

Intersection												
Int Delay, s/veh	2.1											
Movement	EBL	EBT	EBR	WBL	WBT	WBR	NBL	NBT	NBR	SBL	SBT	SBR
Lane Configurations		↑	↗	↘	↑						↑	↗
Traffic Vol, veh/h	0	78	137	5	436	0	0	0	0	70	6	12
Future Vol, veh/h	0	78	137	5	436	0	0	0	0	70	6	12
Conflicting Peds, #/hr	0	0	0	0	0	0	0	0	0	0	0	0
Sign Control	Free	Free	Free	Free	Free	Free	Stop	Stop	Stop	Stop	Stop	Stop
RT Channelized	-	-	Free	-	-	None	-	-	None	-	-	Yield
Storage Length	-	-	390	55	-	-	-	-	-	-	-	32
Veh in Median Storage, #	-	0	-	-	0	-	-	-	-	-	0	-
Grade, %	-	0	-	-	0	-	-	0	-	-	0	-
Peak Hour Factor	88	88	88	88	88	88	88	88	88	88	88	88
Heavy Vehicles, %	2	2	2	2	2	2	2	2	2	2	2	2
Mvmt Flow	0	89	156	6	495	0	0	0	0	80	7	14

Major/Minor	Major1			Major2			Minor2			
Conflicting Flow All	-	0	-	89	0	0	-	596	596	495
Stage 1	-	-	-	-	-	-	-	507	507	-
Stage 2	-	-	-	-	-	-	-	89	89	-
Critical Hdwy	-	-	-	4.12	-	-	-	6.42	6.52	6.22
Critical Hdwy Stg 1	-	-	-	-	-	-	-	5.42	5.52	-
Critical Hdwy Stg 2	-	-	-	-	-	-	-	5.42	5.52	-
Follow-up Hdwy	-	-	-	2.218	-	-	-	3.518	4.018	3.318
Pot Cap-1 Maneuver	0	-	0	1506	-	0	-	466	417	575
Stage 1	0	-	0	-	-	0	-	605	539	-
Stage 2	0	-	0	-	-	0	-	934	821	-
Platoon blocked, %	-	-	-	-	-	-	-	-	-	-
Mov Cap-1 Maneuver	-	-	-	1506	-	-	-	464	0	575
Mov Cap-2 Maneuver	-	-	-	-	-	-	-	464	0	-
Stage 1	-	-	-	-	-	-	-	603	0	-
Stage 2	-	-	-	-	-	-	-	934	0	-

Approach	EB	WB	SB
HCM Control Delay, s	0	0.1	14.1
HCM LOS			B

Minor Lane/Major Mvmt	EBT	WBL	WBT	SBLn1	SBLn2
Capacity (veh/h)	-	1506	-	464	575
HCM Lane V/C Ratio	-	0.004	-	0.186	0.024
HCM Control Delay (s)	-	7.4	-	14.5	11.4
HCM Lane LOS	-	A	-	B	B
HCM 95th %tile Q(veh)	-	0	-	0.7	0.1

Intersection												
Int Delay, s/veh	6.6											
Movement	EBL	EBT	EBR	WBL	WBT	WBR	NBL	NBT	NBR	SBL	SBT	SBR
Lane Configurations		↑	↑		↑	↑	↑		↑			
Traffic Vol, veh/h	0	143	9	0	198	39	239	0	21	0	0	0
Future Vol, veh/h	0	143	9	0	198	39	239	0	21	0	0	0
Conflicting Peds, #/hr	0	0	0	0	0	0	0	0	0	0	0	0
Sign Control	Free	Free	Free	Free	Free	Free	Stop	Stop	Stop	Stop	Stop	Stop
RT Channelized	-	-	Free	-	-	Free	-	-	Stop	-	-	None
Storage Length	-	-	200	-	-	100	0	-	150	-	-	-
Veh in Median Storage, #	-	0	-	-	0	-	-	0	-	-	16965	-
Grade, %	-	0	-	-	0	-	-	0	-	-	0	-
Peak Hour Factor	86	86	86	86	86	86	86	86	86	86	86	86
Heavy Vehicles, %	2	2	2	2	2	2	2	2	2	2	2	2
Mvmt Flow	0	166	10	0	230	45	278	0	24	0	0	0

Major/Minor	Major1		Major2		Minor1	
Conflicting Flow All	-	0	-	-	0	396
Stage 1	-	-	-	-	-	166
Stage 2	-	-	-	-	-	230
Critical Hdwy	-	-	-	-	-	6.42
Critical Hdwy Stg 1	-	-	-	-	-	5.42
Critical Hdwy Stg 2	-	-	-	-	-	5.42
Follow-up Hdwy	-	-	-	-	-	3.518
Pot Cap-1 Maneuver	0	-	0	0	-	609
Stage 1	0	-	0	0	-	863
Stage 2	0	-	0	0	-	808
Platoon blocked, %	-	-	-	-	-	-
Mov Cap-1 Maneuver	-	-	-	-	-	609
Mov Cap-2 Maneuver	-	-	-	-	-	609
Stage 1	-	-	-	-	-	863
Stage 2	-	-	-	-	-	808

Approach	EB	WB	NB
HCM Control Delay, s	0	0	15.3
HCM LOS			C

Minor Lane/Major Mvmt	NBLn1	NBLn2	EBT	WBT
Capacity (veh/h)	609	878	-	-
HCM Lane V/C Ratio	0.456	0.028	-	-
HCM Control Delay (s)	15.8	9.2	-	-
HCM Lane LOS	C	A	-	-
HCM 95th %tile Q(veh)	2.4	0.1	-	-

Intersection						
Int Delay, s/veh	6.3					
Movement	EBL	EBR	NBL	NBT	SBT	SBR
Lane Configurations	↘↗		↘	↑	↑	↘
Traffic Vol, veh/h	23	155	398	271	131	19
Future Vol, veh/h	23	155	398	271	131	19
Conflicting Peds, #/hr	0	0	0	0	0	0
Sign Control	Stop	Stop	Free	Free	Free	Free
RT Channelized	-	None	-	None	-	None
Storage Length	0	-	110	-	-	50
Veh in Median Storage, #	0	-	-	0	0	-
Grade, %	0	-	-	0	0	-
Peak Hour Factor	94	94	94	94	94	94
Heavy Vehicles, %	2	2	2	2	2	2
Mvmt Flow	24	165	423	288	139	20

Major/Minor	Minor2	Major1	Major2			
Conflicting Flow All	1273	139	159	0	-	0
Stage 1	139	-	-	-	-	-
Stage 2	1134	-	-	-	-	-
Critical Hdwy	6.42	6.22	4.12	-	-	-
Critical Hdwy Stg 1	5.42	-	-	-	-	-
Critical Hdwy Stg 2	5.42	-	-	-	-	-
Follow-up Hdwy	3.518	3.318	2.218	-	-	-
Pot Cap-1 Maneuver	185	909	1420	-	-	-
Stage 1	888	-	-	-	-	-
Stage 2	307	-	-	-	-	-
Platoon blocked, %				-	-	-
Mov Cap-1 Maneuver	130	909	1420	-	-	-
Mov Cap-2 Maneuver	130	-	-	-	-	-
Stage 1	623	-	-	-	-	-
Stage 2	307	-	-	-	-	-

Approach	EB	NB	SB
HCM Control Delay, s	16.1	5.1	0
HCM LOS	C		

Minor Lane/Major Mvmt	NBL	NBT	EBLn1	SBT	SBR
Capacity (veh/h)	1420	-	512	-	-
HCM Lane V/C Ratio	0.298	-	0.37	-	-
HCM Control Delay (s)	8.6	-	16.1	-	-
HCM Lane LOS	A	-	C	-	-
HCM 95th %tile Q(veh)	1.3	-	1.7	-	-

Intersection						
Int Delay, s/veh	10.8					
Movement	WBL	WBR	NBT	NBR	SBL	SBT
Lane Configurations	Y		T		T	T
Traffic Vol, veh/h	139	40	639	206	42	275
Future Vol, veh/h	139	40	639	206	42	275
Conflicting Peds, #/hr	0	0	0	0	0	0
Sign Control	Stop	Stop	Free	Free	Free	Free
RT Channelized	-	None	-	None	-	None
Storage Length	0	-	-	-	165	-
Veh in Median Storage, #	0	-	0	-	-	0
Grade, %	0	-	0	-	-	0
Peak Hour Factor	93	93	93	93	93	93
Heavy Vehicles, %	2	2	2	2	2	2
Mvmt Flow	149	43	687	222	45	296













Major/Minor	Minor1	Major1	Major2		
Conflicting Flow All	1184	798	0	0	909
Stage 1	798	-	-	-	-
Stage 2	386	-	-	-	-
Critical Hdwy	6.42	6.22	-	-	4.12
Critical Hdwy Stg 1	5.42	-	-	-	-
Critical Hdwy Stg 2	5.42	-	-	-	-
Follow-up Hdwy	3.518	3.318	-	-	2.218
Pot Cap-1 Maneuver	209	386	-	-	749
Stage 1	443	-	-	-	-
Stage 2	687	-	-	-	-
Platoon blocked, %			-	-	-
Mov Cap-1 Maneuver	196	386	-	-	749
Mov Cap-2 Maneuver	196	-	-	-	-
Stage 1	416	-	-	-	-
Stage 2	687	-	-	-	-

Approach	WB	NB	SB
HCM Control Delay, s	78.3	0	1.3
HCM LOS	F		

Minor Lane/Major Mvmt	NBT	NBRWBLn1	SBL	SBT
Capacity (veh/h)	-	-	220	749
HCM Lane V/C Ratio	-	-	0.875	0.06
HCM Control Delay (s)	-	-	78.3	10.1
HCM Lane LOS	-	-	F	B
HCM 95th %tile Q(veh)	-	-	6.9	0.2

HCM 2010 Signalized Intersection Summary
 11: Old Highway 395 & Gopher Canyon Road

Existing + Project PM Peak Hour
 07/10/2019

								
Movement	EBL	EBR	NBL	NBT	SBT	SBR		
Lane Configurations								
Traffic Volume (veh/h)	517	239	254	340	182	234		
Future Volume (veh/h)	517	239	254	340	182	234		
Number	7	14	5	2	6	16		
Initial Q (Qb), veh	0	0	0	0	0	0		
Ped-Bike Adj(A_pbT)	1.00	1.00	1.00			1.00		
Parking Bus, Adj	1.00	1.00	1.00	1.00	1.00	1.00		
Adj Sat Flow, veh/h/ln	1863	1863	1863	1863	1863	1863		
Adj Flow Rate, veh/h	539	249	265	354	190	244		
Adj No. of Lanes	1	1	1	1	1	1		
Peak Hour Factor	0.96	0.96	0.96	0.96	0.96	0.96		
Percent Heavy Veh, %	2	2	2	2	2	2		
Cap, veh/h	537	777	333	952	428	364		
Arrive On Green	0.30	0.30	0.19	0.51	0.23	0.23		
Sat Flow, veh/h	1774	1583	1774	1863	1863	1583		
Grp Volume(v), veh/h	539	249	265	354	190	244		
Grp Sat Flow(s),veh/h/ln	1774	1583	1774	1863	1863	1583		
Q Serve(g_s), s	13.0	4.1	6.1	4.9	3.8	6.0		
Cycle Q Clear(g_c), s	13.0	4.1	6.1	4.9	3.8	6.0		
Prop In Lane	1.00	1.00	1.00			1.00		
Lane Grp Cap(c), veh/h	537	777	333	952	428	364		
V/C Ratio(X)	1.00	0.32	0.80	0.37	0.44	0.67		
Avail Cap(c_a), veh/h	537	777	496	1909	1215	1033		
HCM Platoon Ratio	1.00	1.00	1.00	1.00	1.00	1.00		
Upstream Filter(I)	1.00	1.00	1.00	1.00	1.00	1.00		
Uniform Delay (d), s/veh	15.0	6.6	16.7	6.3	14.2	15.0		
Incr Delay (d2), s/veh	39.6	0.2	5.4	0.2	0.7	2.1		
Initial Q Delay(d3),s/veh	0.0	0.0	0.0	0.0	0.0	0.0		
%ile BackOfQ(50%),veh/ln	12.2	0.1	3.4	2.5	2.0	2.8		
LnGrp Delay(d),s/veh	54.6	6.8	22.0	6.6	14.9	17.2		
LnGrp LOS	F	A	C	A	B	B		
Approach Vol, veh/h	788			619	434			
Approach Delay, s/veh	39.5			13.2	16.2			
Approach LOS	D			B	B			
Timer	1	2	3	4	5	6	7	8
Assigned Phs	2		4		5	6		
Phs Duration (G+Y+Rc), s	25.9		17.0		12.1	13.9		
Change Period (Y+Rc), s	4.0		4.0		4.0	4.0		
Max Green Setting (Gmax), s	44.0		13.0		12.0	28.0		
Max Q Clear Time (g_c+I1), s	6.9		15.0		8.1	8.0		
Green Ext Time (p_c), s	2.3		0.0		0.3	1.9		
Intersection Summary								
HCM 2010 Ctrl Delay	25.2							
HCM 2010 LOS	C							

Intersection												
Int Delay, s/veh	3.3											
Movement	EBL	EBT	EBR	WBL	WBT	WBR	NBL	NBT	NBR	SBL	SBT	SBR
Lane Configurations		↕			↕			↕			↕	
Traffic Vol, veh/h	8	1	5	4	0	4	16	28	4	7	25	8
Future Vol, veh/h	8	1	5	4	0	4	16	28	4	7	25	8
Conflicting Peds, #/hr	0	0	0	0	0	0	0	0	0	0	0	0
Sign Control	Stop	Stop	Stop	Stop	Stop	Stop	Free	Free	Free	Free	Free	Free
RT Channelized	-	-	None	-	-	None	-	-	None	-	-	None
Storage Length	-	-	-	-	-	-	-	-	-	-	-	-
Veh in Median Storage, #	-	0	-	-	0	-	-	0	-	-	0	-
Grade, %	-	0	-	-	0	-	-	0	-	-	0	-
Peak Hour Factor	78	78	78	78	78	78	78	78	78	78	78	78
Heavy Vehicles, %	2	2	2	2	2	2	2	2	2	2	2	2
Mvmt Flow	10	1	6	5	0	5	21	36	5	9	32	10

Major/Minor	Minor2		Minor1		Major1		Major2					
Conflicting Flow All	138	138	37	140	141	39	42	0	0	41	0	0
Stage 1	55	55	-	81	81	-	-	-	-	-	-	-
Stage 2	83	83	-	59	60	-	-	-	-	-	-	-
Critical Hdwy	7.12	6.52	6.22	7.12	6.52	6.22	4.12	-	-	4.12	-	-
Critical Hdwy Stg 1	6.12	5.52	-	6.12	5.52	-	-	-	-	-	-	-
Critical Hdwy Stg 2	6.12	5.52	-	6.12	5.52	-	-	-	-	-	-	-
Follow-up Hdwy	3.518	4.018	3.318	3.518	4.018	3.318	2.218	-	-	2.218	-	-
Pot Cap-1 Maneuver	833	753	1035	830	750	1033	1567	-	-	1568	-	-
Stage 1	957	849	-	927	828	-	-	-	-	-	-	-
Stage 2	925	826	-	953	845	-	-	-	-	-	-	-
Platoon blocked, %								-	-	-	-	-
Mov Cap-1 Maneuver	816	738	1035	811	735	1033	1567	-	-	1568	-	-
Mov Cap-2 Maneuver	816	738	-	811	735	-	-	-	-	-	-	-
Stage 1	944	844	-	914	816	-	-	-	-	-	-	-
Stage 2	908	814	-	940	840	-	-	-	-	-	-	-

Approach	EB		WB		NB		SB	
HCM Control Delay, s	9.2		9		2.4		1.3	
HCM LOS	A		A					

Minor Lane/Major Mvmt	NBL	NBT	NBR	EBLn1WBLn1	SBL	SBT	SBR
Capacity (veh/h)	1567	-	-	876	909	1568	-
HCM Lane V/C Ratio	0.013	-	-	0.02	0.011	0.006	-
HCM Control Delay (s)	7.3	0	-	9.2	9	7.3	0
HCM Lane LOS	A	A	-	A	A	A	A
HCM 95th %tile Q(veh)	0	-	-	0.1	0	0	-

Intersection						
Int Delay, s/veh	3.4					
Movement	WBL	WBR	NBT	NBR	SBL	SBT
Lane Configurations	W	R	T	R	L	T
Traffic Vol, veh/h	28	22	28	68	30	31
Future Vol, veh/h	28	22	28	68	30	31
Conflicting Peds, #/hr	0	0	0	0	0	0
Sign Control	Stop	Stop	Free	Free	Free	Free
RT Channelized	-	None	-	None	-	None
Storage Length	0	-	-	-	-	-
Veh in Median Storage, #	0	-	0	-	-	0
Grade, %	0	-	0	-	-	0
Peak Hour Factor	87	87	87	87	87	87
Heavy Vehicles, %	2	2	2	2	2	2
Mvmt Flow	32	25	32	78	34	36

Major/Minor	Minor1	Major1	Major2		
Conflicting Flow All	175	71	0	0	110
Stage 1	71	-	-	-	-
Stage 2	104	-	-	-	-
Critical Hdwy	6.42	6.22	-	-	4.12
Critical Hdwy Stg 1	5.42	-	-	-	-
Critical Hdwy Stg 2	5.42	-	-	-	-
Follow-up Hdwy	3.518	3.318	-	-	2.218
Pot Cap-1 Maneuver	815	991	-	-	1480
Stage 1	952	-	-	-	-
Stage 2	920	-	-	-	-
Platoon blocked, %			-	-	-
Mov Cap-1 Maneuver	796	991	-	-	1480
Mov Cap-2 Maneuver	796	-	-	-	-
Stage 1	930	-	-	-	-
Stage 2	920	-	-	-	-

Approach	WB	NB	SB
HCM Control Delay, s	9.4	0	3.7
HCM LOS	A		

Minor Lane/Major Mvmt	NBT	NBRWBLn1	SBL	SBT
Capacity (veh/h)	-	-	871	1480
HCM Lane V/C Ratio	-	-	0.066	0.023
HCM Control Delay (s)	-	-	9.4	7.5
HCM Lane LOS	-	-	A	A
HCM 95th %tile Q(veh)	-	-	0.2	0.1

Intersection						
Int Delay, s/veh	3.8					
Movement	EBL	EBR	NBL	NBT	SBT	SBR
Lane Configurations	T		T		T	
Traffic Vol, veh/h	43	42	47	104	69	18
Future Vol, veh/h	43	42	47	104	69	18
Conflicting Peds, #/hr	0	0	0	0	0	0
Sign Control	Stop	Stop	Free	Free	Free	Free
RT Channelized	-	None	-	None	-	None
Storage Length	0	-	-	-	-	-
Veh in Median Storage, #	0	-	-	0	0	-
Grade, %	0	-	-	0	0	-
Peak Hour Factor	86	86	86	86	86	86
Heavy Vehicles, %	2	2	2	2	2	2
Mvmt Flow	50	49	55	121	80	21

Major/Minor	Minor2	Major1		Major2	
Conflicting Flow All	322	91	101	0	0
Stage 1	91	-	-	-	-
Stage 2	231	-	-	-	-
Critical Hdwy	6.42	6.22	4.12	-	-
Critical Hdwy Stg 1	5.42	-	-	-	-
Critical Hdwy Stg 2	5.42	-	-	-	-
Follow-up Hdwy	3.518	3.318	2.218	-	-
Pot Cap-1 Maneuver	672	967	1491	-	-
Stage 1	933	-	-	-	-
Stage 2	807	-	-	-	-
Platoon blocked, %				-	-
Mov Cap-1 Maneuver	645	967	1491	-	-
Mov Cap-2 Maneuver	645	-	-	-	-
Stage 1	896	-	-	-	-
Stage 2	807	-	-	-	-

Approach	EB	NB	SB
HCM Control Delay, s	10.3	2.3	0
HCM LOS	B		

Minor Lane/Major Mvmt	NBL	NBT	EBLn1	SBT	SBR
Capacity (veh/h)	1491	-	772	-	-
HCM Lane V/C Ratio	0.037	-	0.128	-	-
HCM Control Delay (s)	7.5	0	10.3	-	-
HCM Lane LOS	A	A	B	-	-
HCM 95th %tile Q(veh)	0.1	-	0.4	-	-

Intersection						
Int Delay, s/veh	3.7					
Movement	EBL	EBT	WBT	WBR	SBL	SBR
Lane Configurations	↘	↑	↑	↗	↘	↘
Traffic Vol, veh/h	58	316	196	147	134	18
Future Vol, veh/h	58	316	196	147	134	18
Conflicting Peds, #/hr	0	0	0	0	0	0
Sign Control	Free	Free	Free	Free	Stop	Stop
RT Channelized	-	None	-	None	-	None
Storage Length	165	-	-	80	0	-
Veh in Median Storage, #	-	0	0	-	0	-
Grade, %	-	0	0	-	0	-
Peak Hour Factor	97	97	97	97	97	97
Heavy Vehicles, %	2	2	2	2	2	2
Mvmt Flow	60	326	202	152	138	19























Major/Minor	Major1	Major2	Minor2		
Conflicting Flow All	354	0	-	0	648 202
Stage 1	-	-	-	-	202 -
Stage 2	-	-	-	-	446 -
Critical Hdwy	4.12	-	-	-	6.42 6.22
Critical Hdwy Stg 1	-	-	-	-	5.42 -
Critical Hdwy Stg 2	-	-	-	-	5.42 -
Follow-up Hdwy	2.218	-	-	-	3.518 3.318
Pot Cap-1 Maneuver	1205	-	-	-	435 839
Stage 1	-	-	-	-	832 -
Stage 2	-	-	-	-	645 -
Platoon blocked, %		-	-	-	
Mov Cap-1 Maneuver	1205	-	-	-	413 839
Mov Cap-2 Maneuver	-	-	-	-	413 -
Stage 1	-	-	-	-	790 -
Stage 2	-	-	-	-	645 -

Approach	EB	WB	SB
HCM Control Delay, s	1.3	0	17.7
HCM LOS			C

Minor Lane/Major Mvmt	EBL	EBT	WBT	WBR	SBLn1
Capacity (veh/h)	1205	-	-	-	439
HCM Lane V/C Ratio	0.05	-	-	-	0.357
HCM Control Delay (s)	8.1	-	-	-	17.7
HCM Lane LOS	A	-	-	-	C
HCM 95th %tile Q(veh)	0.2	-	-	-	1.6

HCM 2010 Signalized Intersection Summary
 16: SR-76 & Old River Rd/East Vista Way

Existing + Project PM Peak Hour
 07/10/2019

												
Movement	EBL	EBT	EBR	WBL	WBT	WBR	NBL	NBT	NBR	SBL	SBT	SBR
Lane Configurations												
Traffic Volume (veh/h)	14	36	131	196	43	652	64	1702	274	509	993	21
Future Volume (veh/h)	14	36	131	196	43	652	64	1702	274	509	993	21
Number	7	4	14	3	8	18	5	2	12	1	6	16
Initial Q (Qb), veh	0	0	0	0	0	0	0	0	0	0	0	0
Ped-Bike Adj(A_pbT)	1.00		1.00	1.00		1.00	1.00		1.00	1.00		1.00
Parking Bus, Adj	1.00	1.00	1.00	1.00	1.00	1.00	1.00	1.00	1.00	1.00	1.00	1.00
Adj Sat Flow, veh/h/ln	1900	1863	1900	1863	1863	1863	1863	1863	1863	1863	1863	1900
Adj Flow Rate, veh/h	15	38	136	236	0	679	67	1773	285	530	1034	22
Adj No. of Lanes	0	2	0	2	0	1	1	3	1	2	3	0
Peak Hour Factor	0.96	0.96	0.96	0.96	0.96	0.96	0.96	0.96	0.96	0.96	0.96	0.96
Percent Heavy Veh, %	2	2	2	2	2	2	2	2	2	2	2	2
Cap, veh/h	51	130	156	684	0	573	88	2074	646	582	2702	57
Arrive On Green	0.10	0.10	0.10	0.19	0.00	0.19	0.05	0.41	0.41	0.17	0.53	0.53
Sat Flow, veh/h	520	1317	1583	3548	0	1583	1774	5085	1583	3442	5125	109
Grp Volume(v), veh/h	53	0	136	236	0	679	67	1773	285	530	684	372
Grp Sat Flow(s),veh/h/ln	1837	0	1583	1774	0	1583	1774	1695	1583	1721	1695	1844
Q Serve(g_s), s	5.3	0.0	16.7	11.3	0.0	38.0	7.4	62.5	25.6	29.8	23.6	23.6
Cycle Q Clear(g_c), s	5.3	0.0	16.7	11.3	0.0	38.0	7.4	62.5	25.6	29.8	23.6	23.6
Prop In Lane	0.28		1.00	1.00		1.00	1.00		1.00	1.00		0.06
Lane Grp Cap(c), veh/h	181	0	156	684	0	573	88	2074	646	582	1788	972
V/C Ratio(X)	0.29	0.00	0.87	0.35	0.00	1.19	0.76	0.86	0.44	0.91	0.38	0.38
Avail Cap(c_a), veh/h	279	0	241	684	0	573	270	2269	707	733	1788	972
HCM Platoon Ratio	1.00	1.00	1.00	1.00	1.00	1.00	1.00	1.00	1.00	1.00	1.00	1.00
Upstream Filter(I)	1.00	0.00	1.00	1.00	0.00	1.00	1.00	1.00	1.00	1.00	1.00	1.00
Uniform Delay (d), s/veh	82.5	0.0	87.6	68.8	0.0	62.9	92.6	53.1	42.2	80.5	27.6	27.6
Incr Delay (d2), s/veh	0.9	0.0	18.6	0.3	0.0	100.3	12.8	3.2	0.5	13.4	0.1	0.2
Initial Q Delay(d3),s/veh	0.0	0.0	0.0	0.0	0.0	0.0	0.0	0.0	0.0	0.0	0.0	0.0
%ile BackOfQ(50%),veh/ln	2.7	0.0	8.1	5.6	0.0	47.1	3.9	29.8	11.3	15.3	11.1	12.1
LnGrp Delay(d),s/veh	83.4	0.0	106.2	69.1	0.0	163.2	105.4	56.3	42.6	93.9	27.7	27.8
LnGrp LOS	F		F	E		F	F	E	D	F	C	C
Approach Vol, veh/h		189			915			2125			1586	
Approach Delay, s/veh		99.8			138.9			56.0			49.9	
Approach LOS		F			F			E			D	
Timer	1	2	3	4	5	6	7	8				
Assigned Phs	1	2		4	5	6		8				
Phs Duration (G+Y+Rc), s	39.0	87.9		25.9	15.4	111.5		44.4				
Change Period (Y+Rc), s	* 5.7	7.5		6.4	* 5.7	7.5		6.4				
Max Green Setting (Gmax), s	* 42	88.0		30.0	* 30	87.0		38.0				
Max Q Clear Time (g_c+I1), s	31.8	64.5		18.7	9.4	25.6		40.0				
Green Ext Time (p_c), s	1.5	15.9		0.8	0.1	9.2		0.0				
Intersection Summary												
HCM 2010 Ctrl Delay				71.5								
HCM 2010 LOS				E								
Notes												

HCM 2010 Signalized Intersection Summary
 17: SR-76 & N River Rd

Existing + Project PM Peak Hour
 07/10/2019



Movement	EBL	EBR	NBL	NBT	SBT	SBR		
Lane Configurations								
Traffic Volume (veh/h)	349	220	105	2246	1349	186		
Future Volume (veh/h)	349	220	105	2246	1349	186		
Number	7	14	5	2	6	16		
Initial Q (Qb), veh	0	0	0	0	0	0		
Ped-Bike Adj(A_pbT)	1.00	1.00	1.00			1.00		
Parking Bus, Adj	1.00	1.00	1.00	1.00	1.00	1.00		
Adj Sat Flow, veh/h/ln	1863	1863	1863	1863	1863	1863		
Adj Flow Rate, veh/h	364	229	109	2340	1405	194		
Adj No. of Lanes	1	1	1	2	2	1		
Peak Hour Factor	0.96	0.96	0.96	0.96	0.96	0.96		
Percent Heavy Veh, %	2	2	2	2	2	2		
Cap, veh/h	404	361	135	2356	1927	862		
Arrive On Green	0.23	0.23	0.08	0.67	0.54	0.54		
Sat Flow, veh/h	1774	1583	1774	3632	3632	1583		
Grp Volume(v), veh/h	364	229	109	2340	1405	194		
Grp Sat Flow(s),veh/h/ln	1774	1583	1774	1770	1770	1583		
Q Serve(g_s), s	25.5	16.7	7.7	83.3	38.3	8.1		
Cycle Q Clear(g_c), s	25.5	16.7	7.7	83.3	38.3	8.1		
Prop In Lane	1.00	1.00	1.00			1.00		
Lane Grp Cap(c), veh/h	404	361	135	2356	1927	862		
V/C Ratio(X)	0.90	0.63	0.80	0.99	0.73	0.23		
Avail Cap(c_a), veh/h	556	496	403	2356	3326	1488		
HCM Platoon Ratio	1.00	1.00	1.00	1.00	1.00	1.00		
Upstream Filter(I)	1.00	1.00	1.00	1.00	1.00	1.00		
Uniform Delay (d), s/veh	47.9	44.5	58.0	21.1	22.0	15.1		
Incr Delay (d2), s/veh	14.0	1.8	10.5	17.0	0.5	0.1		
Initial Q Delay(d3),s/veh	0.0	0.0	0.0	0.0	0.0	0.0		
%ile BackOfQ(50%),veh/ln	4.0	14.5	4.2	45.8	18.7	3.6		
LnGrp Delay(d),s/veh	61.9	46.3	68.6	38.0	22.5	15.2		
LnGrp LOS	E	D	E	D	C	B		
Approach Vol, veh/h	593			2449	1599			
Approach Delay, s/veh	55.9			39.4	21.6			
Approach LOS	E			D	C			
Timer	1	2	3	4	5	6	7	8
Assigned Phs		2		4	5	6		
Phs Duration (G+Y+Rc), s		92.5		35.2	15.5	77.0		
Change Period (Y+Rc), s		7.5		6.1	* 5.7	7.5		
Max Green Setting (Gmax), s		85.0		40.0	* 29	120.0		
Max Q Clear Time (g_c+I1), s		85.3		27.5	9.7	40.3		
Green Ext Time (p_c), s		0.0		1.7	0.2	19.2		
Intersection Summary								
HCM 2010 Ctrl Delay			35.4					
HCM 2010 LOS			D					
Notes								

HCM 2010 Signalized Intersection Summary
 18: SR-76 & Via Montellano

Existing + Project PM Peak Hour
 07/10/2019



Movement	EBL	EBR	NBL	NBT	SBT	SBR		
Lane Configurations								
Traffic Volume (veh/h)	5	3	10	2591	1530	5		
Future Volume (veh/h)	5	3	10	2591	1530	5		
Number	7	14	5	2	6	16		
Initial Q (Qb), veh	0	0	0	0	0	0		
Ped-Bike Adj(A_pbT)	1.00	1.00	1.00			1.00		
Parking Bus, Adj	1.00	1.00	1.00	1.00	1.00	1.00		
Adj Sat Flow, veh/h/ln	1863	1900	1863	1863	1863	1863		
Adj Flow Rate, veh/h	5	3	11	2756	1628	5		
Adj No. of Lanes	0	0	1	2	2	1		
Peak Hour Factor	0.94	0.94	0.94	0.94	0.94	0.94		
Percent Heavy Veh, %	0	0	2	2	2	2		
Cap, veh/h	21	13	42	2973	2685	1201		
Arrive On Green	0.02	0.02	0.02	0.84	0.76	0.76		
Sat Flow, veh/h	952	571	1774	3632	3632	1583		
Grp Volume(v), veh/h	9	0	11	2756	1628	5		
Grp Sat Flow(s),veh/h/ln	1714	0	1774	1770	1770	1583		
Q Serve(g_s), s	0.5	0.0	0.6	55.6	20.3	0.1		
Cycle Q Clear(g_c), s	0.5	0.0	0.6	55.6	20.3	0.1		
Prop In Lane	0.56	0.33	1.00			1.00		
Lane Grp Cap(c), veh/h	38	0	42	2973	2685	1201		
V/C Ratio(X)	0.24	0.00	0.26	0.93	0.61	0.00		
Avail Cap(c_a), veh/h	590	0	431	3046	3118	1395		
HCM Platoon Ratio	1.00	1.00	1.00	1.00	1.00	1.00		
Upstream Filter(I)	1.00	0.00	1.00	1.00	1.00	1.00		
Uniform Delay (d), s/veh	47.5	0.0	47.4	5.7	5.3	2.9		
Incr Delay (d2), s/veh	3.2	0.0	3.2	5.6	0.3	0.0		
Initial Q Delay(d3),s/veh	0.0	0.0	0.0	0.0	0.0	0.0		
%ile BackOfQ(50%),veh/ln	0.3	0.0	0.3	28.0	9.8	0.0		
LnGrp Delay(d),s/veh	50.6	0.0	50.6	11.3	5.6	2.9		
LnGrp LOS	D		D	B	A	A		
Approach Vol, veh/h	9			2767	1633			
Approach Delay, s/veh	50.6			11.4	5.6			
Approach LOS	D			B	A			
Timer	1	2	3	4	5	6	7	8
Assigned Phs		2		4	5	6		
Phs Duration (G+Y+Rc), s		90.5		8.3	8.0	82.4		
Change Period (Y+Rc), s		7.5		6.1	* 5.7	7.5		
Max Green Setting (Gmax), s		85.0		34.0	* 24	87.0		
Max Q Clear Time (g_c+I1), s		57.6		2.5	2.6	22.3		
Green Ext Time (p_c), s		25.4		0.0	0.0	22.6		
Intersection Summary								
HCM 2010 Ctrl Delay			9.3					
HCM 2010 LOS			A					
Notes								

HCM 2010 Signalized Intersection Summary
 19: I-15 SB Ramps & Highway 76

Existing + Project PM Peak Hour

07/10/2019



Movement	EBL	EBT	EBR	WBL	WBT	WBR	NBL	NBT	NBR	SBL	SBT	SBR
Lane Configurations		↑↑↑	↗		↑↑	↗				↖	↔	↗
Traffic Volume (veh/h)	0	1070	207	0	679	125	0	0	0	57	0	704
Future Volume (veh/h)	0	1070	207	0	679	125	0	0	0	57	0	704
Number	5	2	12	1	6	16				7	4	14
Initial Q (Qb), veh	0	0	0	0	0	0				0	0	0
Ped-Bike Adj(A_pbT)	1.00		1.00	1.00		1.00				1.00		1.00
Parking Bus, Adj	1.00	1.00	1.00	1.00	1.00	1.00				1.00	1.00	1.00
Adj Sat Flow, veh/h/ln	0	1863	1863	0	1863	1863				1863	1863	1863
Adj Flow Rate, veh/h	0	1092	211	0	693	128				39	0	739
Adj No. of Lanes	0	3	1	0	2	1				1	0	2
Peak Hour Factor	0.98	0.98	0.98	0.98	0.98	0.98				0.98	0.98	0.98
Percent Heavy Veh, %	0	2	2	0	2	2				2	2	2
Cap, veh/h	0	2134	664	0	1485	1165				561	0	1002
Arrive On Green	0.00	0.42	0.42	0.00	0.42	0.42				0.32	0.00	0.32
Sat Flow, veh/h	0	5253	1583	0	3632	1583				1774	0	3167
Grp Volume(v), veh/h	0	1092	211	0	693	128				39	0	739
Grp Sat Flow(s),veh/h/ln	0	1695	1583	0	1770	1583				1774	0	1583
Q Serve(g_s), s	0.0	8.2	4.6	0.0	7.3	1.2				0.8	0.0	10.7
Cycle Q Clear(g_c), s	0.0	8.2	4.6	0.0	7.3	1.2				0.8	0.0	10.7
Prop In Lane	0.00		1.00	0.00		1.00				1.00		1.00
Lane Grp Cap(c), veh/h	0	2134	664	0	1485	1165				561	0	1002
V/C Ratio(X)	0.00	0.51	0.32	0.00	0.47	0.11				0.07	0.00	0.74
Avail Cap(c_a), veh/h	0	5431	1691	0	3986	2284				1722	0	3074
HCM Platoon Ratio	1.00	1.00	1.00	1.00	1.00	1.00				1.00	1.00	1.00
Upstream Filter(I)	0.00	1.00	1.00	0.00	1.00	1.00				1.00	0.00	1.00
Uniform Delay (d), s/veh	0.0	11.0	10.0	0.0	10.8	2.0				12.3	0.0	15.7
Incr Delay (d2), s/veh	0.0	0.2	0.3	0.0	0.2	0.0				0.1	0.0	1.1
Initial Q Delay(d3),s/veh	0.0	0.0	0.0	0.0	0.0	0.0				0.0	0.0	0.0
%ile BackOfQ(50%),veh/ln	0.0	3.8	2.0	0.0	3.5	1.2				0.4	0.0	4.8
LnGrp Delay(d),s/veh	0.0	11.2	10.3	0.0	11.0	2.0				12.4	0.0	16.8
LnGrp LOS		B	B		B	A				B		B
Approach Vol, veh/h		1303			821						778	
Approach Delay, s/veh		11.1			9.6						16.6	
Approach LOS		B			A						B	
Timer	1	2	3	4	5	6	7	8				
Assigned Phs		2		4		6						
Phs Duration (G+Y+Rc), s		29.1		22.4		29.1						
Change Period (Y+Rc), s		7.5		6.1		7.5						
Max Green Setting (Gmax), s		55.0		50.0		58.0						
Max Q Clear Time (g_c+I1), s		10.2		12.7		9.3						
Green Ext Time (p_c), s		11.4		3.6		6.2						
Intersection Summary												
HCM 2010 Ctrl Delay				12.1								
HCM 2010 LOS				B								
Notes												

HCM 2010 Signalized Intersection Summary
 20: I-15 NB Ramps & Highway 76































Existing + Project PM Peak Hour
 07/10/2019



Movement	EBL	EBT	EBR	WBL	WBT	WBR	NBL	NBT	NBR	SBL	SBT	SBR
Lane Configurations		↑↑	↑		↑↑↑	↑	↑	↑	↑			
Traffic Volume (veh/h)	0	486	633	0	337	52	430	0	766	0	0	0
Future Volume (veh/h)	0	486	633	0	337	52	430	0	766	0	0	0
Number	5	2	12	1	6	16	3	8	18			
Initial Q (Qb), veh	0	0	0	0	0	0	0	0	0			
Ped-Bike Adj(A_pbT)	1.00		1.00	1.00		1.00	1.00		1.00			
Parking Bus, Adj	1.00	1.00	1.00	1.00	1.00	1.00	1.00	1.00	1.00			
Adj Sat Flow, veh/h/ln	0	1863	1863	0	1863	1863	1863	1863	1863			
Adj Flow Rate, veh/h	0	496	646	0	344	53	293	0	939			
Adj No. of Lanes	0	2	1	0	3	1	1	0	2			
Peak Hour Factor	0.98	0.98	0.98	0.98	0.98	0.98	0.98	0.98	0.98			
Percent Heavy Veh, %	0	2	2	0	2	2	2	2	2			
Cap, veh/h	0	1227	1180	0	1763	549	707	0	1261			
Arrive On Green	0.00	0.35	0.35	0.00	0.35	0.35	0.40	0.00	0.40			
Sat Flow, veh/h	0	3632	1583	0	5253	1583	1774	0	3167			
Grp Volume(v), veh/h	0	496	646	0	344	53	293	0	939			
Grp Sat Flow(s),veh/h/ln	0	1770	1583	0	1695	1583	1774	0	1583			
Q Serve(g_s), s	0.0	5.7	9.4	0.0	2.5	1.2	6.3	0.0	13.5			
Cycle Q Clear(g_c), s	0.0	5.7	9.4	0.0	2.5	1.2	6.3	0.0	13.5			
Prop In Lane	0.00		1.00	0.00		1.00	1.00		1.00			
Lane Grp Cap(c), veh/h	0	1227	1180	0	1763	549	707	0	1261			
V/C Ratio(X)	0.00	0.40	0.55	0.00	0.20	0.10	0.41	0.00	0.74			
Avail Cap(c_a), veh/h	0	3385	2145	0	3433	1069	1464	0	2613			
HCM Platoon Ratio	1.00	1.00	1.00	1.00	1.00	1.00	1.00	1.00	1.00			
Upstream Filter(I)	0.00	1.00	1.00	0.00	1.00	1.00	1.00	0.00	1.00			
Uniform Delay (d), s/veh	0.0	13.2	2.9	0.0	12.2	11.8	11.6	0.0	13.7			
Incr Delay (d2), s/veh	0.0	0.2	0.4	0.0	0.1	0.1	0.4	0.0	0.9			
Initial Q Delay(d3),s/veh	0.0	0.0	0.0	0.0	0.0	0.0	0.0	0.0	0.0			
%ile BackOfQ(50%),veh/ln	0.0	2.8	9.5	0.0	1.2	0.5	3.2	0.0	6.0			
LnGrp Delay(d),s/veh	0.0	13.5	3.3	0.0	12.3	11.9	12.0	0.0	14.6			
LnGrp LOS		B	A		B	B	B		B			
Approach Vol, veh/h		1142			397			1232				
Approach Delay, s/veh		7.7			12.2			14.0				
Approach LOS		A			B			B				
Timer	1	2	3	4	5	6	7	8				
Assigned Phs		2				6		8				
Phs Duration (G+Y+Rc), s		26.0				26.0		27.3				
Change Period (Y+Rc), s		7.5				7.5		6.1				
Max Green Setting (Gmax), s		51.0				36.0		44.0				
Max Q Clear Time (g_c+I1), s		11.4				4.5		15.5				
Green Ext Time (p_c), s		7.1				2.6		5.7				
Intersection Summary												
HCM 2010 Ctrl Delay			11.1									
HCM 2010 LOS			B									
Notes												

HCM 2010 Signalized Intersection Summary
 1: Highway 76 & Olive Hill Road/Camino Del Rey

Existing + Cumulative + Project AM
 07/10/2019

												
Movement	EBL	EBT	EBR	WBL	WBT	WBR	NBL	NBT	NBR	SBL	SBT	SBR
Lane Configurations	 							  		 	  	
Traffic Volume (veh/h)	152	354	249	228	204	250	139	1489	280	609	2951	235
Future Volume (veh/h)	152	354	249	228	204	250	139	1489	280	609	2951	235
Number	7	4	14	3	8	18	5	2	12	1	6	16
Initial Q (Qb), veh	0	0	0	0	0	0	0	0	0	0	0	0
Ped-Bike Adj(A_pbT)	1.00		1.00	1.00		1.00	1.00		1.00	1.00		1.00
Parking Bus, Adj	1.00	1.00	1.00	1.00	1.00	1.00	1.00	1.00	1.00	1.00	1.00	1.00
Adj Sat Flow, veh/h/ln	1863	1863	1863	1863	1863	1863	1863	1863	1863	1863	1863	1863
Adj Flow Rate, veh/h	165	385	271	248	222	272	151	1618	304	662	3208	255
Adj No. of Lanes	2	1	1	1	1	1	1	3	1	2	3	1
Peak Hour Factor	0.92	0.92	0.92	0.92	0.92	0.92	0.92	0.92	0.92	0.92	0.92	0.92
Percent Heavy Veh, %	2	2	2	2	2	2	2	2	2	2	2	2
Cap, veh/h	495	268	228	333	349	297	166	1820	567	701	2378	740
Arrive On Green	0.14	0.14	0.14	0.19	0.19	0.19	0.09	0.36	0.36	0.20	0.47	0.47
Sat Flow, veh/h	3442	1863	1583	1774	1863	1583	1774	5085	1583	3442	5085	1583
Grp Volume(v), veh/h	165	385	271	248	222	272	151	1618	304	662	3208	255
Grp Sat Flow(s),veh/h/ln	1721	1863	1583	1774	1863	1583	1774	1695	1583	1721	1695	1583
Q Serve(g_s), s	10.2	34.0	34.0	31.2	26.0	39.9	19.9	70.9	36.1	44.9	110.6	24.2
Cycle Q Clear(g_c), s	10.2	34.0	34.0	31.2	26.0	39.9	19.9	70.9	36.1	44.9	110.6	24.2
Prop In Lane	1.00		1.00	1.00		1.00	1.00		1.00	1.00		1.00
Lane Grp Cap(c), veh/h	495	268	228	333	349	297	166	1820	567	701	2378	740
V/C Ratio(X)	0.33	1.44	1.19	0.75	0.64	0.92	0.91	0.89	0.54	0.94	1.35	0.34
Avail Cap(c_a), veh/h	495	268	228	397	417	355	225	1935	602	756	2378	740
HCM Platoon Ratio	1.00	1.00	1.00	1.00	1.00	1.00	1.00	1.00	1.00	1.00	1.00	1.00
Upstream Filter(I)	1.00	1.00	1.00	1.00	1.00	1.00	1.00	1.00	1.00	1.00	1.00	1.00
Uniform Delay (d), s/veh	91.1	101.3	101.3	90.8	88.7	94.3	106.2	71.5	60.4	92.9	63.0	40.0
Incr Delay (d2), s/veh	0.4	217.2	121.0	6.2	2.4	25.2	30.1	5.3	0.8	19.7	159.9	0.3
Initial Q Delay(d3),s/veh	0.0	0.0	0.0	0.0	0.0	0.0	0.0	0.0	0.0	0.0	0.0	0.0
%ile BackOfQ(50%),veh/ln	4.9	33.6	22.5	15.9	13.7	19.5	11.2	34.2	15.9	23.3	87.0	10.6
LnGrp Delay(d),s/veh	91.5	318.5	222.3	96.9	91.0	119.5	136.3	76.9	61.2	112.6	222.8	40.2
LnGrp LOS	F	F	F	F	F	F	F	E	E	F	F	D
Approach Vol, veh/h		821			742			2073			4125	
Approach Delay, s/veh		241.1			103.4			78.9			193.9	
Approach LOS		F			F			E			F	
Timer	1	2	3	4	5	6	7	8				
Assigned Phs	1	2		4	5	6		8				
Phs Duration (G+Y+Rc), s	53.9	92.2		40.1	27.9	118.1		50.5				
Change Period (Y+Rc), s	* 5.7	7.5		6.1	* 5.7	7.5		6.1				
Max Green Setting (Gmax), s	* 52	90.0		34.0	* 30	90.0		53.0				
Max Q Clear Time (g_c+I1), s	46.9	72.9		36.0	21.9	112.6		41.9				
Green Ext Time (p_c), s	1.3	11.8		0.0	0.2	0.0		2.5				
Intersection Summary												
HCM 2010 Ctrl Delay			159.5									
HCM 2010 LOS			F									
Notes												

Intersection						
Int Delay, s/veh	0					
Movement	EBL	EBR	NBL	NBT	SBT	SBR
Lane Configurations	↘↙		↘	↑	↑	↘
Traffic Vol, veh/h	828	247	162	127	137	645
Future Vol, veh/h	828	247	162	127	137	645
Conflicting Peds, #/hr	0	0	0	0	0	0
Sign Control	Free	Free	Stop	Stop	Free	Free
RT Channelized	-	Free	-	None	-	Free
Storage Length	0	-	150	-	-	150
Veh in Median Storage, #	-	-	-	0	0	-
Grade, %	0	-	-	0	0	-
Peak Hour Factor	82	82	82	82	82	82
Heavy Vehicles, %	2	2	2	2	2	2
Mvmt Flow	1010	301	198	155	167	787

Major/Minor	Minor2	Major2		
Conflicting Flow All	167	167	-	0
Stage 1	167	167	-	-
Stage 2	0	0	-	-
Critical Hdwy	6.42	6.52	-	-
Critical Hdwy Stg 1	5.42	5.52	-	-
Critical Hdwy Stg 2	-	-	-	-
Follow-up Hdwy	3.518	4.018	-	-
Pot Cap-1 Maneuver	823	726	-	0
Stage 1	863	760	-	0
Stage 2	-	-	-	0
Platoon blocked, %			-	
Mov Cap-1 Maneuver	823	0	-	-
Mov Cap-2 Maneuver	823	0	-	-
Stage 1	863	0	-	-
Stage 2	-	0	-	-

Approach	NB	SB
HCM Control Delay, s		0
HCM LOS	-	

Minor Lane/Major Mvmt	NBLn1	NBLn2	SBT
Capacity (veh/h)	823	-	-
HCM Lane V/C Ratio	0.24	-	-
HCM Control Delay (s)	10.8	-	-
HCM Lane LOS	B	-	-
HCM 95th %tile Q(veh)	0.9	-	-

Intersection						
Int Delay, s/veh	9.6					
Movement	EBL	EBT	WBT	WBR	SBL	SBR
Lane Configurations		↔	↔		↔	↔
Traffic Vol, veh/h	331	627	397	34	27	295
Future Vol, veh/h	331	627	397	34	27	295
Conflicting Peds, #/hr	0	0	0	0	0	0
Sign Control	Free	Free	Free	Free	Stop	Stop
RT Channelized	-	None	-	None	-	Stop
Storage Length	-	-	-	-	0	100
Veh in Median Storage, #	-	0	0	-	0	-
Grade, %	-	0	0	-	0	-
Peak Hour Factor	90	90	90	90	90	90
Heavy Vehicles, %	2	2	2	2	2	2
Mvmt Flow	368	697	441	38	30	328





























Major/Minor	Major1	Major2	Minor2		
Conflicting Flow All	479	0	-	0	1893 460
Stage 1	-	-	-	-	460 -
Stage 2	-	-	-	-	1433 -
Critical Hdwy	4.12	-	-	-	6.42 6.22
Critical Hdwy Stg 1	-	-	-	-	5.42 -
Critical Hdwy Stg 2	-	-	-	-	5.42 -
Follow-up Hdwy	2.218	-	-	-	3.518 3.318
Pot Cap-1 Maneuver	1083	-	-	-	77 601
Stage 1	-	-	-	-	636 -
Stage 2	-	-	-	-	220 -
Platoon blocked, %		-	-	-	
Mov Cap-1 Maneuver	1083	-	-	-	34 601
Mov Cap-2 Maneuver	-	-	-	-	34 -
Stage 1	-	-	-	-	284 -
Stage 2	-	-	-	-	220 -

Approach	EB	WB	SB
HCM Control Delay, s	3.5	0	40.8
HCM LOS			E

Minor Lane/Major Mvmt	EBL	EBT	WBT	WBR	SBLn1	SBLn2
Capacity (veh/h)	1083	-	-	-	34	601
HCM Lane V/C Ratio	0.34	-	-	-	0.882	0.545
HCM Control Delay (s)	10	0	-	-	291.2	17.9
HCM Lane LOS	B	A	-	-	F	C
HCM 95th %tile Q(veh)	1.5	-	-	-	3.1	3.3

HCM 2010 Signalized Intersection Summary
4: Old Highway 395 & Highway 76

Existing + Cumulative + Project AM
07/10/2019

												
Movement	EBL	EBT	EBR	WBL	WBT	WBR	NBL	NBT	NBR	SBL	SBT	SBR
Lane Configurations		  			 					 		
Traffic Volume (veh/h)	118	1074	317	367	1421	147	344	272	254	306	530	208
Future Volume (veh/h)	118	1074	317	367	1421	147	344	272	254	306	530	208
Number	5	2	12	1	6	16	3	8	18	7	4	14
Initial Q (Qb), veh	0	0	0	0	0	0	0	0	0	0	0	0
Ped-Bike Adj(A_pbT)	1.00		1.00	1.00		1.00	1.00		1.00	1.00		1.00
Parking Bus, Adj	1.00	1.00	1.00	1.00	1.00	1.00	1.00	1.00	1.00	1.00	1.00	1.00
Adj Sat Flow, veh/h/ln	1863	1863	1863	1863	1863	1863	1863	1863	1863	1863	1863	1900
Adj Flow Rate, veh/h	123	1119	229	382	1480	0	358	283	191	319	552	212
Adj No. of Lanes	1	3	1	1	2	1	1	1	1	2	1	0
Peak Hour Factor	0.96	0.96	0.96	0.96	0.96	0.96	0.96	0.96	0.96	0.96	0.96	0.96
Percent Heavy Veh, %	2	2	2	2	2	2	2	2	2	2	2	2
Cap, veh/h	141	1309	408	270	1168	984	261	299	495	1004	403	155
Arrive On Green	0.08	0.26	0.26	0.15	0.33	0.00	0.15	0.16	0.16	0.29	0.31	0.31
Sat Flow, veh/h	1774	5085	1583	1774	3539	1583	1774	1863	1583	3442	1283	493
Grp Volume(v), veh/h	123	1119	229	382	1480	0	358	283	191	319	0	764
Grp Sat Flow(s),veh/h/ln	1774	1695	1583	1774	1770	1583	1774	1863	1583	1721	0	1776
Q Serve(g_s), s	14.0	42.7	25.6	31.0	67.3	0.0	30.0	30.7	8.2	14.8	0.0	64.0
Cycle Q Clear(g_c), s	14.0	42.7	25.6	31.0	67.3	0.0	30.0	30.7	8.2	14.8	0.0	64.0
Prop In Lane	1.00		1.00	1.00		1.00	1.00		1.00	1.00		0.28
Lane Grp Cap(c), veh/h	141	1309	408	270	1168	984	261	299	495	1004	0	557
V/C Ratio(X)	0.87	0.85	0.56	1.42	1.27	0.00	1.37	0.95	0.39	0.32	0.00	1.37
Avail Cap(c_a), veh/h	235	1497	466	270	1168	984	261	302	497	1004	0	557
HCM Platoon Ratio	1.00	1.00	1.00	1.00	1.00	1.00	1.00	1.00	1.00	1.00	1.00	1.00
Upstream Filter(I)	1.00	1.00	1.00	1.00	1.00	0.00	1.00	1.00	1.00	1.00	0.00	1.00
Uniform Delay (d), s/veh	92.8	72.1	65.7	86.4	68.3	0.0	86.9	84.7	22.5	56.4	0.0	69.9
Incr Delay (d2), s/veh	17.1	4.6	1.2	207.7	127.1	0.0	189.6	37.4	0.5	0.2	0.0	177.9
Initial Q Delay(d3),s/veh	0.0	0.0	0.0	0.0	0.0	0.0	0.0	0.0	0.0	0.0	0.0	0.0
%ile BackOfQ(50%),veh/ln	7.5	20.6	11.4	30.7	53.4	0.0	28.4	18.9	4.0	7.1	0.0	58.8
LnGrp Delay(d),s/veh	109.9	76.7	66.9	294.2	195.4	0.0	276.5	122.1	23.0	56.6	0.0	247.9
LnGrp LOS	F	E	E	F	F		F	F	C	E		F
Approach Vol, veh/h		1471			1862			832			1083	
Approach Delay, s/veh		77.9			215.7			165.8			191.5	
Approach LOS		E			F			F			F	
Timer	1	2	3	4	5	6	7	8				
Assigned Phs	1	2	3	4	5	6	7	8				
Phs Duration (G+Y+Rc), s	36.7	60.0	35.7	71.5	21.9	74.8	67.0	40.2				
Change Period (Y+Rc), s	* 5.7	7.5	* 5.7	7.5	* 5.7	7.5	7.5	* 7.5				
Max Green Setting (Gmax), s	* 31	60.0	* 30	64.0	* 27	65.0	48.0	* 33				
Max Q Clear Time (g_c+I1), s	33.0	44.7	32.0	66.0	16.0	69.3	16.8	32.7				
Green Ext Time (p_c), s	0.0	7.8	0.0	0.0	0.2	0.0	1.1	0.1				
Intersection Summary												
HCM 2010 Ctrl Delay	164.2											
HCM 2010 LOS	F											
Notes												

Intersection						
Int Delay, s/veh	295.6					
Movement	WBL	WBR	NBT	NBR	SBL	SBT
Lane Configurations						
Traffic Vol, veh/h	261	191	583	201	48	1050
Future Vol, veh/h	261	191	583	201	48	1050
Conflicting Peds, #/hr	0	0	0	0	0	0
Sign Control	Stop	Stop	Free	Free	Free	Free
RT Channelized	-	None	-	None	-	None
Storage Length	0	385	-	-	-	-
Veh in Median Storage, #	0	-	0	-	-	0
Grade, %	0	-	0	-	-	0
Peak Hour Factor	88	88	88	88	88	88
Heavy Vehicles, %	2	2	2	2	2	2
Mvmt Flow	297	217	663	228	55	1193

Major/Minor	Minor1	Major1	Major2		
Conflicting Flow All	2080	777	0	0	891
Stage 1	777	-	-	-	-
Stage 2	1303	-	-	-	-
Critical Hdwy	6.42	6.22	-	-	4.12
Critical Hdwy Stg 1	5.42	-	-	-	-
Critical Hdwy Stg 2	5.42	-	-	-	-
Follow-up Hdwy	3.518	3.318	-	-	2.218
Pot Cap-1 Maneuver	~ 59	397	-	-	761
Stage 1	453	-	-	-	-
Stage 2	~ 254	-	-	-	-
Platoon blocked, %			-	-	-
Mov Cap-1 Maneuver	~ 46	397	-	-	761
Mov Cap-2 Maneuver	~ 46	-	-	-	-
Stage 1	356	-	-	-	-
Stage 2	~ 254	-	-	-	-

Approach	WB	NB	SB
HCM Control Delay, \$	1525.6	0	0.4
HCM LOS	F		

Minor Lane/Major Mvmt	NBT	NBR	WBLn1	WBLn2	SBL	SBT
Capacity (veh/h)	-	-	46	397	761	-
HCM Lane V/C Ratio	-	-	6.448	0.547	0.072	-
HCM Control Delay (s)	-	\$	2624.1	24.5	10.1	0
HCM Lane LOS	-	-	F	C	B	A
HCM 95th %tile Q(veh)	-	-	34.5	3.2	0.2	-

Notes
 -: Volume exceeds capacity \$: Delay exceeds 300s +: Computation Not Defined *: All major volume in platoon

Intersection												
Int Delay, s/veh	1											
Movement	EBL	EBT	EBR	WBL	WBT	WBR	NBL	NBT	NBR	SBL	SBT	SBR
Lane Configurations		↕	↗		↕	↗	↗	↖		↗	↖	
Traffic Vol, veh/h	151	49	137	376	83	200	123	345	244	148	878	169
Future Vol, veh/h	151	49	137	376	83	200	123	345	244	148	878	169
Conflicting Peds, #/hr	0	0	0	0	0	0	0	0	0	0	0	0
Sign Control	Stop	Stop	Stop	Stop	Stop	Stop	Free	Free	Free	Free	Free	Free
RT Channelized	-	-	Stop	-	-	Stop	-	-	None	-	-	None
Storage Length	-	-	25	-	-	50	210	-	-	200	-	530
Veh in Median Storage, #	-	0	-	-	0	-	-	0	-	-	0	-
Grade, %	-	0	-	-	0	-	-	0	-	-	0	-
Peak Hour Factor	95	95	95	95	95	95	95	95	95	95	95	95
Heavy Vehicles, %	2	2	2	2	2	2	2	2	2	2	2	2
Mvmt Flow	159	52	144	396	87	211	129	363	257	156	924	178

Major/Minor	Minor2		Minor1		Major1		Major2					
Conflicting Flow All	2118	2203	551	1550	2164	492	1102	0	0	620	0	0
Stage 1	1325	1325	-	750	750	-	-	-	-	-	-	-
Stage 2	793	878	-	800	1414	-	-	-	-	-	-	-
Critical Hdwy	7.33	6.53	6.93	7.33	6.53	6.23	4.13	-	-	4.13	-	-
Critical Hdwy Stg 1	6.53	5.53	-	6.13	5.53	-	-	-	-	-	-	-
Critical Hdwy Stg 2	6.13	5.53	-	6.53	5.53	-	-	-	-	-	-	-
Follow-up Hdwy	3.519	4.019	3.319	3.519	4.019	3.319	2.219	-	-	2.219	-	-
Pot Cap-1 Maneuver	~ 32	~ 44	479	~ 85	~ 47	576	631	-	-	958	-	-
Stage 1	165	224	-	403	418	-	-	-	-	-	-	-
Stage 2	381	365	-	~ 346	203	-	-	-	-	-	-	-
Platoon blocked, %								-	-	-	-	-
Mov Cap-1 Maneuver	-	~ 29	479	-	~ 31	576	631	-	-	958	-	-
Mov Cap-2 Maneuver	-	~ 29	-	-	~ 31	-	-	-	-	-	-	-
Stage 1	~ 131	187	-	~ 321	333	-	-	-	-	-	-	-
Stage 2	~ 142	291	-	~ 147	170	-	-	-	-	-	-	-

Approach	EB		WB		NB		SB	
HCM Control Delay, s					2.1		1.2	
HCM LOS	-		-					

Minor Lane/Major Mvmt	NBL	NBT	NBR	EBLn1	EBLn2	WBLn1	WBLn2	SBL	SBT	SBR
Capacity (veh/h)	631	-	-	-	479	-	576	958	-	-
HCM Lane V/C Ratio	0.205	-	-	-	0.301	-	0.365	0.163	-	-
HCM Control Delay (s)	12.2	-	-	-	15.7	-	14.8	9.5	-	-
HCM Lane LOS	B	-	-	-	C	-	B	A	-	-
HCM 95th %tile Q(veh)	0.8	-	-	-	1.3	-	1.7	0.6	-	-

Notes
 -: Volume exceeds capacity \$: Delay exceeds 300s +: Computation Not Defined *: All major volume in platoon

Intersection												
Int Delay, s/veh	44.8											
Movement	EBL	EBT	EBR	WBL	WBT	WBR	NBL	NBT	NBR	SBL	SBT	SBR
Lane Configurations		↑	↗	↘	↑						↑	↗
Traffic Vol, veh/h	0	596	788	25	454	0	0	0	0	229	12	65
Future Vol, veh/h	0	596	788	25	454	0	0	0	0	229	12	65
Conflicting Peds, #/hr	0	0	0	0	0	0	0	0	0	0	0	0
Sign Control	Free	Free	Free	Free	Free	Free	Stop	Stop	Stop	Stop	Stop	Stop
RT Channelized	-	-	Free	-	-	None	-	-	None	-	-	Yield
Storage Length	-	-	390	55	-	-	-	-	-	-	-	32
Veh in Median Storage, #	-	0	-	-	0	-	-	-	-	-	0	-
Grade, %	-	0	-	-	0	-	-	0	-	-	0	-
Peak Hour Factor	90	90	90	90	90	90	90	90	90	90	90	90
Heavy Vehicles, %	2	2	2	2	2	2	2	2	2	2	2	2
Mvmt Flow	0	662	876	28	504	0	0	0	0	254	13	72

Major/Minor	Major1			Major2			Minor2			
Conflicting Flow All	-	0	-	662	0	0		1222	1222	504
Stage 1	-	-	-	-	-	-		560	560	-
Stage 2	-	-	-	-	-	-		662	662	-
Critical Hdwy	-	-	-	4.12	-	-		6.42	6.52	6.22
Critical Hdwy Stg 1	-	-	-	-	-	-		5.42	5.52	-
Critical Hdwy Stg 2	-	-	-	-	-	-		5.42	5.52	-
Follow-up Hdwy	-	-	-	2.218	-	-		3.518	4.018	3.318
Pot Cap-1 Maneuver	0	-	0	927	-	0		~ 198	180	568
Stage 1	0	-	0	-	-	0		572	511	-
Stage 2	0	-	0	-	-	0		513	459	-
Platoon blocked, %		-			-					
Mov Cap-1 Maneuver	-	-	-	927	-	-		~ 192	0	568
Mov Cap-2 Maneuver	-	-	-	-	-	-		~ 192	0	-
Stage 1	-	-	-	-	-	-		555	0	-
Stage 2	-	-	-	-	-	-		513	0	-

Approach	EB	WB	SB
HCM Control Delay, s	0	0.5	201.6
HCM LOS			F

Minor Lane/Major Mvmt	EBT	WBL	WBT	SBLn1	SBLn2
Capacity (veh/h)	-	927	-	192	568
HCM Lane V/C Ratio	-	0.03	-	1.395	0.127
HCM Control Delay (s)	-	9	-	252.7	12.3
HCM Lane LOS	-	A	-	F	B
HCM 95th %tile Q(veh)	-	0.1	-	15.8	0.4

Notes
 -: Volume exceeds capacity \$: Delay exceeds 300s +: Computation Not Defined *: All major volume in platoon

Intersection												
Int Delay, s/veh	105.5											
Movement	EBL	EBT	EBR	WBL	WBT	WBR	NBL	NBT	NBR	SBL	SBT	SBR
Lane Configurations		↑	↗		↑	↗	↘		↗			
Traffic Vol, veh/h	0	695	185	0	351	91	303	0	49	0	0	0
Future Vol, veh/h	0	695	185	0	351	91	303	0	49	0	0	0
Conflicting Peds, #/hr	0	0	0	0	0	0	0	0	0	0	0	0
Sign Control	Free	Free	Free	Free	Free	Free	Stop	Stop	Stop	Stop	Stop	Stop
RT Channelized	-	-	Free	-	-	Free	-	-	Stop	-	-	None
Storage Length	-	-	200	-	-	100	0	-	150	-	-	-
Veh in Median Storage, #	-	0	-	-	0	-	-	0	-	-	16965	-
Grade, %	-	0	-	-	0	-	-	0	-	-	0	-
Peak Hour Factor	83	83	83	83	83	83	83	83	83	83	83	83
Heavy Vehicles, %	2	2	2	2	2	2	2	2	2	2	2	2
Mvmt Flow	0	837	223	0	423	110	365	0	59	0	0	0

Major/Minor	Major1		Major2		Minor1	
Conflicting Flow All	-	0	-	-	0	1260
Stage 1	-	-	-	-	-	837
Stage 2	-	-	-	-	-	423
Critical Hdwy	-	-	-	-	-	6.42
Critical Hdwy Stg 1	-	-	-	-	-	5.42
Critical Hdwy Stg 2	-	-	-	-	-	5.42
Follow-up Hdwy	-	-	-	-	-	3.518
Pot Cap-1 Maneuver	0	-	0	0	-	0 ~ 188
Stage 1	0	-	0	0	-	0 425
Stage 2	0	-	0	0	-	0 661
Platoon blocked, %	-	-	-	-	-	-
Mov Cap-1 Maneuver	-	-	-	-	-	~ 188
Mov Cap-2 Maneuver	-	-	-	-	-	~ 188
Stage 1	-	-	-	-	-	425
Stage 2	-	-	-	-	-	661

Approach	EB	WB	NB
HCM Control Delay, s	0	0	\$ 419.2
HCM LOS			F

Minor Lane/Major Mvmt	NBLn1	NBLn2	EBT	WBT
Capacity (veh/h)	188	367	-	-
HCM Lane V/C Ratio	1.942	0.161	-	-
HCM Control Delay (s)	\$ 484.3	16.7	-	-
HCM Lane LOS	F	C	-	-
HCM 95th %tile Q(veh)	27.2	0.6	-	-

Notes
 -: Volume exceeds capacity \$: Delay exceeds 300s +: Computation Not Defined *: All major volume in platoon

Intersection						
Int Delay, s/veh	46.1					
Movement	EBL	EBR	NBL	NBT	SBT	SBR
Lane Configurations						
Traffic Vol, veh/h	48	321	144	301	691	51
Future Vol, veh/h	48	321	144	301	691	51
Conflicting Peds, #/hr	0	0	0	0	0	0
Sign Control	Stop	Stop	Free	Free	Free	Free
RT Channelized	-	None	-	None	-	None
Storage Length	0	-	110	-	-	50
Veh in Median Storage, #	0	-	-	0	0	-
Grade, %	0	-	-	0	0	-
Peak Hour Factor	91	91	91	91	91	91
Heavy Vehicles, %	2	2	2	2	2	2
Mvmt Flow	53	353	158	331	759	56

Major/Minor	Minor2	Major1	Major2			
Conflicting Flow All	1406	759	815	0	-	0
Stage 1	759	-	-	-	-	-
Stage 2	647	-	-	-	-	-
Critical Hdwy	6.42	6.22	4.12	-	-	-
Critical Hdwy Stg 1	5.42	-	-	-	-	-
Critical Hdwy Stg 2	5.42	-	-	-	-	-
Follow-up Hdwy	3.518	3.318	2.218	-	-	-
Pot Cap-1 Maneuver	153	406	812	-	-	-
Stage 1	462	-	-	-	-	-
Stage 2	521	-	-	-	-	-
Platoon blocked, %				-	-	-
Mov Cap-1 Maneuver	123	406	812	-	-	-
Mov Cap-2 Maneuver	123	-	-	-	-	-
Stage 1	372	-	-	-	-	-
Stage 2	521	-	-	-	-	-

Approach	EB	NB	SB
HCM Control Delay, s	190.2	3.4	0
HCM LOS	F		

Minor Lane/Major Mvmt	NBL	NBT	EBLn1	SBT	SBR
Capacity (veh/h)	812	-	312	-	-
HCM Lane V/C Ratio	0.195	-	1.3	-	-
HCM Control Delay (s)	10.5	-	190.2	-	-
HCM Lane LOS	B	-	F	-	-
HCM 95th %tile Q(veh)	0.7	-	19.5	-	-













Intersection						
Int Delay, s/veh	287.9					
Movement	WBL	WBR	NBT	NBR	SBL	SBT
Lane Configurations	Y		P		Y	↑
Traffic Vol, veh/h	353	79	376	132	53	972
Future Vol, veh/h	353	79	376	132	53	972
Conflicting Peds, #/hr	0	0	0	0	0	0
Sign Control	Stop	Stop	Free	Free	Free	Free
RT Channelized	-	None	-	None	-	None
Storage Length	0	-	-	-	165	-
Veh in Median Storage, #	0	-	0	-	-	0
Grade, %	0	-	0	-	-	0
Peak Hour Factor	93	93	93	93	93	93
Heavy Vehicles, %	2	2	2	2	2	2
Mvmt Flow	380	85	404	142	57	1045

Major/Minor	Minor1	Major1	Major2		
Conflicting Flow All	1634	475	0	0	546
Stage 1	475	-	-	-	-
Stage 2	1159	-	-	-	-
Critical Hdwy	6.42	6.22	-	-	4.12
Critical Hdwy Stg 1	5.42	-	-	-	-
Critical Hdwy Stg 2	5.42	-	-	-	-
Follow-up Hdwy	3.518	3.318	-	-	2.218
Pot Cap-1 Maneuver	~ 111	590	-	-	1023
Stage 1	626	-	-	-	-
Stage 2	~ 299	-	-	-	-
Platoon blocked, %			-	-	-
Mov Cap-1 Maneuver	~ 105	590	-	-	1023
Mov Cap-2 Maneuver	~ 105	-	-	-	-
Stage 1	591	-	-	-	-
Stage 2	~ 299	-	-	-	-

Approach	WB	NB	SB
HCM Control Delay, \$	1308.2	0	0.5
HCM LOS	F		

Minor Lane/Major Mvmt	NBT	NBRWBLn1	SBL	SBT
Capacity (veh/h)	-	-	124	1023
HCM Lane V/C Ratio	-	-	3.746	0.056
HCM Control Delay (s)	-	\$	1308.2	8.7
HCM Lane LOS	-	-	F	A
HCM 95th %tile Q(veh)	-	-	46.3	0.2

Notes
 -: Volume exceeds capacity \$: Delay exceeds 300s +: Computation Not Defined *: All major volume in platoon

								
Movement	EBL	EBR	NBL	NBT	SBT	SBR		
Lane Configurations								
Traffic Volume (veh/h)	270	280	305	238	620	708		
Future Volume (veh/h)	270	280	305	238	620	708		
Number	7	14	5	2	6	16		
Initial Q (Qb), veh	0	0	0	0	0	0		
Ped-Bike Adj(A_pbT)	1.00	1.00	1.00			1.00		
Parking Bus, Adj	1.00	1.00	1.00	1.00	1.00	1.00		
Adj Sat Flow, veh/h/ln	1863	1863	1863	1863	1863	1863		
Adj Flow Rate, veh/h	297	308	335	262	681	778		
Adj No. of Lanes	1	1	1	1	1	1		
Peak Hour Factor	0.91	0.91	0.91	0.91	0.91	0.91		
Percent Heavy Veh, %	2	2	2	2	2	2		
Cap, veh/h	346	603	330	1269	807	686		
Arrive On Green	0.20	0.20	0.19	0.68	0.43	0.43		
Sat Flow, veh/h	1774	1583	1774	1863	1863	1583		
Grp Volume(v), veh/h	297	308	335	262	681	778		
Grp Sat Flow(s),veh/h/ln	1774	1583	1774	1863	1863	1583		
Q Serve(g_s), s	10.5	9.7	12.0	3.4	21.1	28.0		
Cycle Q Clear(g_c), s	10.5	9.7	12.0	3.4	21.1	28.0		
Prop In Lane	1.00	1.00	1.00			1.00		
Lane Grp Cap(c), veh/h	346	603	330	1269	807	686		
V/C Ratio(X)	0.86	0.51	1.02	0.21	0.84	1.13		
Avail Cap(c_a), veh/h	357	613	330	1269	807	686		
HCM Platoon Ratio	1.00	1.00	1.00	1.00	1.00	1.00		
Upstream Filter(I)	1.00	1.00	1.00	1.00	1.00	1.00		
Uniform Delay (d), s/veh	25.1	15.4	26.3	3.8	16.3	18.3		
Incr Delay (d2), s/veh	18.0	0.7	53.9	0.1	8.1	77.5		
Initial Q Delay(d3),s/veh	0.0	0.0	0.1	0.0	0.0	0.0		
%ile BackOfQ(50%),veh/ln	6.9	9.0	10.7	1.7	12.6	26.8		
LnGrp Delay(d),s/veh	43.2	16.1	80.2	3.9	24.5	95.8		
LnGrp LOS	D	B	F	A	C	F		
Approach Vol, veh/h	605			597	1459			
Approach Delay, s/veh	29.4			46.7	62.5			
Approach LOS	C			D	E			
Timer	1	2	3	4	5	6	7	8
Assigned Phs	2		4		5	6		
Phs Duration (G+Y+Rc), s	48.0		16.6		16.0	32.0		
Change Period (Y+Rc), s	4.0		4.0		4.0	4.0		
Max Green Setting (Gmax), s	44.0		13.0		12.0	28.0		
Max Q Clear Time (g_c+I1), s	5.4		12.5		14.0	30.0		
Green Ext Time (p_c), s	1.7		0.2		0.0	0.0		
Intersection Summary								
HCM 2010 Ctrl Delay			51.4					
HCM 2010 LOS			D					

Intersection												
Int Delay, s/veh	4											
Movement	EBL	EBT	EBR	WBL	WBT	WBR	NBL	NBT	NBR	SBL	SBT	SBR
Lane Configurations		↕			↕			↕			↕	
Traffic Vol, veh/h	12	5	69	5	6	5	44	99	8	26	112	3
Future Vol, veh/h	12	5	69	5	6	5	44	99	8	26	112	3
Conflicting Peds, #/hr	0	0	0	0	0	0	0	0	0	0	0	0
Sign Control	Stop	Stop	Stop	Stop	Stop	Stop	Free	Free	Free	Free	Free	Free
RT Channelized	-	-	None	-	-	None	-	-	None	-	-	None
Storage Length	-	-	-	-	-	-	-	-	-	-	-	-
Veh in Median Storage, #	-	0	-	-	0	-	-	0	-	-	0	-
Grade, %	-	0	-	-	0	-	-	0	-	-	0	-
Peak Hour Factor	86	86	86	86	86	86	86	86	86	86	86	86
Heavy Vehicles, %	2	2	2	2	2	2	2	2	2	2	2	2
Mvmt Flow	14	6	80	6	7	6	51	115	9	30	130	3

Major/Minor	Minor2		Minor1		Major1		Major2					
Conflicting Flow All	420	418	132	457	415	120	133	0	0	124	0	0
Stage 1	192	192	-	222	222	-	-	-	-	-	-	-
Stage 2	228	226	-	235	193	-	-	-	-	-	-	-
Critical Hdwy	7.12	6.52	6.22	7.12	6.52	6.22	4.12	-	-	4.12	-	-
Critical Hdwy Stg 1	6.12	5.52	-	6.12	5.52	-	-	-	-	-	-	-
Critical Hdwy Stg 2	6.12	5.52	-	6.12	5.52	-	-	-	-	-	-	-
Follow-up Hdwy	3.518	4.018	3.318	3.518	4.018	3.318	2.218	-	-	2.218	-	-
Pot Cap-1 Maneuver	544	526	917	514	528	931	1452	-	-	1463	-	-
Stage 1	810	742	-	780	720	-	-	-	-	-	-	-
Stage 2	775	717	-	768	741	-	-	-	-	-	-	-
Platoon blocked, %								-	-	-	-	-
Mov Cap-1 Maneuver	511	495	917	444	497	931	1452	-	-	1463	-	-
Mov Cap-2 Maneuver	511	495	-	444	497	-	-	-	-	-	-	-
Stage 1	779	726	-	750	693	-	-	-	-	-	-	-
Stage 2	733	690	-	680	725	-	-	-	-	-	-	-

Approach	EB		WB		NB		SB	
HCM Control Delay, s	10.2		11.7		2.2		1.4	
HCM LOS	B		B					

Minor Lane/Major Mvmt	NBL	NBT	NBR	EBLn1WBLn1	SBL	SBT	SBR
Capacity (veh/h)	1452	-	-	790	557	1463	-
HCM Lane V/C Ratio	0.035	-	-	0.127	0.033	0.021	-
HCM Control Delay (s)	7.6	0	-	10.2	11.7	7.5	0
HCM Lane LOS	A	A	-	B	B	A	A
HCM 95th %tile Q(veh)	0.1	-	-	0.4	0.1	0.1	-

Intersection						
Int Delay, s/veh	6.9					
Movement	WBL	WBR	NBT	NBR	SBL	SBT
Lane Configurations						
Traffic Vol, veh/h	131	66	58	80	111	125
Future Vol, veh/h	131	66	58	80	111	125
Conflicting Peds, #/hr	0	0	0	0	0	0
Sign Control	Stop	Stop	Free	Free	Free	Free
RT Channelized	-	None	-	None	-	None
Storage Length	0	-	-	-	-	-
Veh in Median Storage, #	0	-	0	-	-	0
Grade, %	0	-	0	-	-	0
Peak Hour Factor	86	86	86	86	86	86
Heavy Vehicles, %	2	2	2	2	2	2
Mvmt Flow	152	77	67	93	129	145

Major/Minor	Minor1	Major1	Major2		
Conflicting Flow All	517	114	0	0	160
Stage 1	114	-	-	-	-
Stage 2	403	-	-	-	-
Critical Hdwy	6.42	6.22	-	-	4.12
Critical Hdwy Stg 1	5.42	-	-	-	-
Critical Hdwy Stg 2	5.42	-	-	-	-
Follow-up Hdwy	3.518	3.318	-	-	2.218
Pot Cap-1 Maneuver	518	939	-	-	1419
Stage 1	911	-	-	-	-
Stage 2	675	-	-	-	-
Platoon blocked, %			-	-	-
Mov Cap-1 Maneuver	467	939	-	-	1419
Mov Cap-2 Maneuver	467	-	-	-	-
Stage 1	821	-	-	-	-
Stage 2	675	-	-	-	-

Approach	WB	NB	SB
HCM Control Delay, s	15.7	0	3.7
HCM LOS	C		

Minor Lane/Major Mvmt	NBT	NBRWBLn1	SBL	SBT
Capacity (veh/h)	-	-	562	1419
HCM Lane V/C Ratio	-	-	0.408	0.091
HCM Control Delay (s)	-	-	15.7	7.8
HCM Lane LOS	-	-	C	A
HCM 95th %tile Q(veh)	-	-	2	0.3

Intersection						
Int Delay, s/veh	5.9					
Movement	EBL	EBR	NBL	NBT	SBT	SBR
Lane Configurations	T			T		T
Traffic Vol, veh/h	48	169	64	66	108	58
Future Vol, veh/h	48	169	64	66	108	58
Conflicting Peds, #/hr	0	0	0	0	0	0
Sign Control	Stop	Stop	Free	Free	Free	Free
RT Channelized	-	None	-	None	-	None
Storage Length	0	-	-	-	-	-
Veh in Median Storage, #	0	-	-	0	0	-
Grade, %	0	-	-	0	0	-
Peak Hour Factor	85	85	85	85	85	85
Heavy Vehicles, %	2	2	2	2	2	2
Mvmt Flow	56	199	75	78	127	68

Major/Minor	Minor2	Major1	Major2			
Conflicting Flow All	389	161	195	0	-	0
Stage 1	161	-	-	-	-	-
Stage 2	228	-	-	-	-	-
Critical Hdwy	6.42	6.22	4.12	-	-	-
Critical Hdwy Stg 1	5.42	-	-	-	-	-
Critical Hdwy Stg 2	5.42	-	-	-	-	-
Follow-up Hdwy	3.518	3.318	2.218	-	-	-
Pot Cap-1 Maneuver	615	884	1378	-	-	-
Stage 1	868	-	-	-	-	-
Stage 2	810	-	-	-	-	-
Platoon blocked, %				-	-	-
Mov Cap-1 Maneuver	580	884	1378	-	-	-
Mov Cap-2 Maneuver	580	-	-	-	-	-
Stage 1	819	-	-	-	-	-
Stage 2	810	-	-	-	-	-

Approach	EB	NB	SB
HCM Control Delay, s	11.7	3.8	0
HCM LOS	B		

Minor Lane/Major Mvmt	NBL	NBT	EBLn1	SBT	SBR
Capacity (veh/h)	1378	-	792	-	-
HCM Lane V/C Ratio	0.055	-	0.322	-	-
HCM Control Delay (s)	7.8	0	11.7	-	-
HCM Lane LOS	A	A	B	-	-
HCM 95th %tile Q(veh)	0.2	-	1.4	-	-

Intersection						
Int Delay, s/veh	21.9					
Movement	EBL	EBT	WBT	WBR	SBL	SBR
Lane Configurations						
Traffic Vol, veh/h	81	225	331	204	249	99
Future Vol, veh/h	81	225	331	204	249	99
Conflicting Peds, #/hr	0	0	0	0	0	0
Sign Control	Free	Free	Free	Free	Stop	Stop
RT Channelized	-	None	-	None	-	None
Storage Length	165	-	-	80	0	-
Veh in Median Storage, #	-	0	0	-	0	-
Grade, %	-	0	0	-	0	-
Peak Hour Factor	92	92	92	92	92	92
Heavy Vehicles, %	2	2	2	2	2	2
Mvmt Flow	88	245	360	222	271	108























Major/Minor	Major1	Major2	Minor2		
Conflicting Flow All	582	0	-	0	781
Stage 1	-	-	-	-	360
Stage 2	-	-	-	-	421
Critical Hdwy	4.12	-	-	-	6.42
Critical Hdwy Stg 1	-	-	-	-	5.42
Critical Hdwy Stg 2	-	-	-	-	5.42
Follow-up Hdwy	2.218	-	-	-	3.518
Pot Cap-1 Maneuver	992	-	-	-	363
Stage 1	-	-	-	-	706
Stage 2	-	-	-	-	662
Platoon blocked, %		-	-	-	
Mov Cap-1 Maneuver	992	-	-	-	331
Mov Cap-2 Maneuver	-	-	-	-	331
Stage 1	-	-	-	-	643
Stage 2	-	-	-	-	662

Approach	EB	WB	SB
HCM Control Delay, s	2.4	0	72.7
HCM LOS			F

Minor Lane/Major Mvmt	EBL	EBT	WBT	WBR	SBLn1
Capacity (veh/h)	992	-	-	-	388
HCM Lane V/C Ratio	0.089	-	-	-	0.975
HCM Control Delay (s)	9	-	-	-	72.7
HCM Lane LOS	A	-	-	-	F
HCM 95th %tile Q(veh)	0.3	-	-	-	11.3

HCM 2010 Signalized Intersection Summary
 16: SR-76 & Old River Rd/East Vista Way

Existing + Cumulative + Project AM
 07/10/2019

												
Movement	EBL	EBT	EBR	WBL	WBT	WBR	NBL	NBT	NBR	SBL	SBT	SBR
Lane Configurations												
Traffic Volume (veh/h)	17	169	210	335	53	415	128	1214	492	735	2333	102
Future Volume (veh/h)	17	169	210	335	53	415	128	1214	492	735	2333	102
Number	7	4	14	3	8	18	5	2	12	1	6	16
Initial Q (Qb), veh	0	0	0	0	0	0	0	0	0	0	0	0
Ped-Bike Adj(A_pbT)	1.00		1.00	1.00		1.00	1.00		1.00	1.00		1.00
Parking Bus, Adj	1.00	1.00	1.00	1.00	1.00	1.00	1.00	1.00	1.00	1.00	1.00	1.00
Adj Sat Flow, veh/h/ln	1900	1863	1900	1863	1863	1863	1863	1863	1863	1863	1863	1900
Adj Flow Rate, veh/h	18	176	219	388	0	432	133	1265	512	766	2430	106
Adj No. of Lanes	0	2	0	2	0	1	1	3	1	2	3	0
Peak Hour Factor	0.96	0.96	0.96	0.96	0.96	0.96	0.96	0.96	0.96	0.96	0.96	0.96
Percent Heavy Veh, %	2	2	2	2	2	2	2	2	2	2	2	2
Cap, veh/h	24	235	221	628	0	590	150	1865	581	673	2388	103
Arrive On Green	0.14	0.14	0.14	0.18	0.00	0.18	0.08	0.37	0.37	0.20	0.48	0.48
Sat Flow, veh/h	172	1682	1583	3548	0	1583	1774	5085	1583	3442	4998	216
Grp Volume(v), veh/h	194	0	219	388	0	432	133	1265	512	766	1642	894
Grp Sat Flow(s),veh/h/ln	1854	0	1583	1774	0	1583	1774	1695	1583	1721	1695	1825
Q Serve(g_s), s	21.6	0.0	29.7	21.7	0.0	38.0	15.9	45.0	65.0	42.0	102.6	102.6
Cycle Q Clear(g_c), s	21.6	0.0	29.7	21.7	0.0	38.0	15.9	45.0	65.0	42.0	102.6	102.6
Prop In Lane	0.09		1.00	1.00		1.00	1.00		1.00	1.00		0.12
Lane Grp Cap(c), veh/h	259	0	221	628	0	590	150	1865	581	673	1620	872
V/C Ratio(X)	0.75	0.00	0.99	0.62	0.00	0.73	0.89	0.68	0.88	1.14	1.01	1.03
Avail Cap(c_a), veh/h	259	0	221	628	0	590	248	2084	649	673	1620	872
HCM Platoon Ratio	1.00	1.00	1.00	1.00	1.00	1.00	1.00	1.00	1.00	1.00	1.00	1.00
Upstream Filter(I)	1.00	0.00	1.00	1.00	0.00	1.00	1.00	1.00	1.00	1.00	1.00	1.00
Uniform Delay (d), s/veh	88.8	0.0	92.2	81.7	0.0	58.2	97.3	57.3	63.6	86.4	56.1	56.1
Incr Delay (d2), s/veh	11.4	0.0	57.6	1.8	0.0	4.7	18.7	0.8	12.5	79.4	25.9	37.1
Initial Q Delay(d3),s/veh	0.0	0.0	0.0	0.0	0.0	0.0	0.0	0.0	0.0	0.0	0.0	0.0
%ile BackOfQ(50%),veh/ln	11.9	0.0	16.5	10.8	0.0	22.9	8.6	21.2	30.5	27.3	53.7	60.6
LnGrp Delay(d),s/veh	100.2	0.0	149.8	83.5	0.0	62.8	116.0	58.1	76.2	165.8	82.0	93.2
LnGrp LOS	F		F	F		E	F	E	E	F	F	F
Approach Vol, veh/h		413			820			1910			3302	
Approach Delay, s/veh		126.5			72.6			67.0			104.5	
Approach LOS		F			E			E			F	
Timer	1	2	3	4	5	6	7	8				
Assigned Phs	1	2		4	5	6		8				
Phs Duration (G+Y+Rc), s	47.7	86.3		36.4	23.9	110.1		44.4				
Change Period (Y+Rc), s	* 5.7	7.5		6.4	* 5.7	7.5		6.4				
Max Green Setting (Gmax), s	* 42	88.0		30.0	* 30	87.0		38.0				
Max Q Clear Time (g_c+I1), s	44.0	67.0		31.7	17.9	104.6		40.0				
Green Ext Time (p_c), s	0.0	11.8		0.0	0.2	0.0		0.0				
Intersection Summary												
HCM 2010 Ctrl Delay			90.7									
HCM 2010 LOS			F									
Notes												

HCM 2010 Signalized Intersection Summary
 17: SR-76 & N River Rd

Existing + Cumulative + Project AM
 07/10/2019



Movement	EBL	EBR	NBL	NBT	SBT	SBR		
Lane Configurations								
Traffic Volume (veh/h)	181	143	138	1736	3019	546		
Future Volume (veh/h)	181	143	138	1736	3019	546		
Number	7	14	5	2	6	16		
Initial Q (Qb), veh	0	0	0	0	0	0		
Ped-Bike Adj(A_pbT)	1.00	1.00	1.00			1.00		
Parking Bus, Adj	1.00	1.00	1.00	1.00	1.00	1.00		
Adj Sat Flow, veh/h/ln	1863	1863	1863	1863	1863	1863		
Adj Flow Rate, veh/h	191	151	145	1827	3178	575		
Adj No. of Lanes	1	1	1	2	2	1		
Peak Hour Factor	0.95	0.95	0.95	0.95	0.95	0.95		
Percent Heavy Veh, %	2	2	2	2	2	2		
Cap, veh/h	218	194	166	2834	2390	1069		
Arrive On Green	0.12	0.12	0.09	0.80	0.68	0.68		
Sat Flow, veh/h	1774	1583	1774	3632	3632	1583		
Grp Volume(v), veh/h	191	151	145	1827	3178	575		
Grp Sat Flow(s),veh/h/ln	1774	1583	1774	1770	1770	1583		
Q Serve(g_s), s	18.8	16.4	14.3	37.8	120.0	32.9		
Cycle Q Clear(g_c), s	18.8	16.4	14.3	37.8	120.0	32.9		
Prop In Lane	1.00	1.00	1.00			1.00		
Lane Grp Cap(c), veh/h	218	194	166	2834	2390	1069		
V/C Ratio(X)	0.88	0.78	0.87	0.64	1.33	0.54		
Avail Cap(c_a), veh/h	399	356	289	2834	2390	1069		
HCM Platoon Ratio	1.00	1.00	1.00	1.00	1.00	1.00		
Upstream Filter(I)	1.00	1.00	1.00	1.00	1.00	1.00		
Uniform Delay (d), s/veh	76.6	75.6	79.5	7.3	28.9	14.7		
Incr Delay (d2), s/veh	10.7	6.6	13.3	0.5	151.4	0.5		
Initial Q Delay(d3),s/veh	0.0	0.0	0.0	0.0	0.0	0.0		
%ile BackOfQ(50%),veh/ln	9.9	14.3	7.7	18.5	108.3	14.5		
LnGrp Delay(d),s/veh	87.3	82.2	92.8	7.8	180.3	15.3		
LnGrp LOS	F	F	F	A	F	B		
Approach Vol, veh/h	342			1972	3753			
Approach Delay, s/veh	85.1			14.1	155.0			
Approach LOS	F			B	F			
Timer	1	2	3	4	5	6	7	8
Assigned Phs		2		4	5	6		
Phs Duration (G+Y+Rc), s		149.8		27.9	22.3	127.5		
Change Period (Y+Rc), s		7.5		6.1	* 5.7	7.5		
Max Green Setting (Gmax), s		85.0		40.0	* 29	120.0		
Max Q Clear Time (g_c+I1), s		39.8		20.8	16.3	122.0		
Green Ext Time (p_c), s		24.2		1.0	0.3	0.0		
Intersection Summary								
HCM 2010 Ctrl Delay			105.2					
HCM 2010 LOS			F					
Notes								



Movement	EBL	EBR	NBL	NBT	SBT	SBR		
Lane Configurations								
Traffic Volume (veh/h)	8	7	3	1966	3531	9		
Future Volume (veh/h)	8	7	3	1966	3531	9		
Number	7	14	5	2	6	16		
Initial Q (Qb), veh	0	0	0	0	0	0		
Ped-Bike Adj(A_pbT)	1.00	1.00	1.00			1.00		
Parking Bus, Adj	1.00	1.00	1.00	1.00	1.00	1.00		
Adj Sat Flow, veh/h/ln	1863	1900	1863	1863	1863	1863		
Adj Flow Rate, veh/h	8	7	3	2006	3603	9		
Adj No. of Lanes	0	0	1	2	2	1		
Peak Hour Factor	0.98	0.98	0.98	0.98	0.98	0.98		
Percent Heavy Veh, %	0	0	2	2	2	2		
Cap, veh/h	30	26	13	2981	2774	1241		
Arrive On Green	0.04	0.04	0.01	0.84	0.78	0.78		
Sat Flow, veh/h	845	739	1774	3632	3632	1583		
Grp Volume(v), veh/h	16	0	3	2006	3603	9		
Grp Sat Flow(s),veh/h/ln	1690	0	1774	1770	1770	1583		
Q Serve(g_s), s	1.0	0.0	0.2	22.9	87.0	0.1		
Cycle Q Clear(g_c), s	1.0	0.0	0.2	22.9	87.0	0.1		
Prop In Lane	0.50	0.44	1.00			1.00		
Lane Grp Cap(c), veh/h	59	0	13	2981	2774	1241		
V/C Ratio(X)	0.27	0.00	0.24	0.67	1.30	0.01		
Avail Cap(c_a), veh/h	518	0	384	2981	2774	1241		
HCM Platoon Ratio	1.00	1.00	1.00	1.00	1.00	1.00		
Upstream Filter(I)	1.00	0.00	1.00	1.00	1.00	1.00		
Uniform Delay (d), s/veh	52.2	0.0	54.8	3.2	12.0	2.6		
Incr Delay (d2), s/veh	2.4	0.0	9.2	0.6	137.2	0.0		
Initial Q Delay(d3),s/veh	0.0	0.0	0.0	0.0	0.0	0.0		
%ile BackOfQ(50%),veh/ln	0.5	0.0	0.1	11.1	94.1	0.1		
LnGrp Delay(d),s/veh	54.6	0.0	64.0	3.8	149.2	2.6		
LnGrp LOS	D		E	A	F	A		
Approach Vol, veh/h	16			2009	3612			
Approach Delay, s/veh	54.6			3.9	148.8			
Approach LOS	D			A	F			
Timer	1	2	3	4	5	6	7	8
Assigned Phs		2		4	5	6		
Phs Duration (G+Y+Rc), s		101.0		10.0	6.5	94.5		
Change Period (Y+Rc), s		7.5		6.1	* 5.7	7.5		
Max Green Setting (Gmax), s		85.0		34.0	* 24	87.0		
Max Q Clear Time (g_c+I1), s		24.9		3.0	2.2	89.0		
Green Ext Time (p_c), s		32.8		0.0	0.0	0.0		
Intersection Summary								
HCM 2010 Ctrl Delay			96.9					
HCM 2010 LOS			F					
Notes								

HCM 2010 Signalized Intersection Summary
 19: I-15 SB Ramps & Highway 76

Existing + Cumulative + Project AM
 07/10/2019



Movement	EBL	EBT	EBR	WBL	WBT	WBR	NBL	NBT	NBR	SBL	SBT	SBR
Lane Configurations		↑↑↑	↗		↑↑	↗				↖	↔	↗
Traffic Volume (veh/h)	0	1486	152	0	915	196	0	0	0	49	0	1348
Future Volume (veh/h)	0	1486	152	0	915	196	0	0	0	49	0	1348
Number	5	2	12	1	6	16				7	4	14
Initial Q (Qb), veh	0	0	0	0	0	0				0	0	0
Ped-Bike Adj(A_pbT)	1.00		1.00	1.00		1.00				1.00		1.00
Parking Bus, Adj	1.00	1.00	1.00	1.00	1.00	1.00				1.00	1.00	1.00
Adj Sat Flow, veh/h/ln	0	1863	1863	0	1863	1863				1863	1863	1863
Adj Flow Rate, veh/h	0	1633	167	0	1005	215				36	0	1500
Adj No. of Lanes	0	3	1	0	2	1				1	0	2
Peak Hour Factor	0.91	0.91	0.91	0.91	0.91	0.91				0.91	0.91	0.91
Percent Heavy Veh, %	0	2	2	0	2	2				2	2	2
Cap, veh/h	0	2136	665	0	1487	1387				809	0	1444
Arrive On Green	0.00	0.42	0.42	0.00	0.42	0.42				0.46	0.00	0.46
Sat Flow, veh/h	0	5253	1583	0	3632	1583				1774	0	3167
Grp Volume(v), veh/h	0	1633	167	0	1005	215				36	0	1500
Grp Sat Flow(s),veh/h/ln	0	1695	1583	0	1770	1583				1774	0	1583
Q Serve(g_s), s	0.0	30.1	7.5	0.0	25.2	2.1				1.2	0.0	50.0
Cycle Q Clear(g_c), s	0.0	30.1	7.5	0.0	25.2	2.1				1.2	0.0	50.0
Prop In Lane	0.00		1.00	0.00		1.00				1.00		1.00
Lane Grp Cap(c), veh/h	0	2136	665	0	1487	1387				809	0	1444
V/C Ratio(X)	0.00	0.76	0.25	0.00	0.68	0.16				0.04	0.00	1.04
Avail Cap(c_a), veh/h	0	2550	794	0	1872	1559				809	0	1444
HCM Platoon Ratio	1.00	1.00	1.00	1.00	1.00	1.00				1.00	1.00	1.00
Upstream Filter(I)	0.00	1.00	1.00	0.00	1.00	1.00				1.00	0.00	1.00
Uniform Delay (d), s/veh	0.0	27.2	20.6	0.0	25.8	1.0				16.6	0.0	29.8
Incr Delay (d2), s/veh	0.0	1.2	0.2	0.0	0.7	0.1				0.0	0.0	34.5
Initial Q Delay(d3),s/veh	0.0	0.0	0.0	0.0	0.0	0.0				0.0	0.0	0.0
%ile BackOfQ(50%),veh/ln	0.0	14.3	3.3	0.0	12.4	4.4				0.6	0.0	28.6
LnGrp Delay(d),s/veh	0.0	28.3	20.8	0.0	26.4	1.0				16.6	0.0	64.3
LnGrp LOS		C	C		C	A				B		F
Approach Vol, veh/h		1800			1220						1536	
Approach Delay, s/veh		27.6			22.0						63.2	
Approach LOS		C			C						E	
Timer	1	2	3	4	5	6	7	8				
Assigned Phs		2		4		6						
Phs Duration (G+Y+Rc), s		53.6		56.1		53.6						
Change Period (Y+Rc), s		7.5		6.1		7.5						
Max Green Setting (Gmax), s		55.0		50.0		58.0						
Max Q Clear Time (g_c+I1), s		32.1		52.0		27.2						
Green Ext Time (p_c), s		14.0		0.0		9.6						
Intersection Summary												
HCM 2010 Ctrl Delay				38.1								
HCM 2010 LOS				D								
Notes												

HCM 2010 Signalized Intersection Summary
 20: I-15 NB Ramps & Highway 76































Existing + Cumulative + Project AM
 07/10/2019



Movement	EBL	EBT	EBR	WBL	WBT	WBR	NBL	NBT	NBR	SBL	SBT	SBR
Lane Configurations		↑↑	↑		↑↑↑	↑	↑	↑	↑			
Traffic Volume (veh/h)	0	962	628	0	933	101	162	0	106	0	0	0
Future Volume (veh/h)	0	962	628	0	933	101	162	0	106	0	0	0
Number	5	2	12	1	6	16	3	8	18			
Initial Q (Qb), veh	0	0	0	0	0	0	0	0	0			
Ped-Bike Adj(A_pbT)	1.00		1.00	1.00		1.00	1.00		1.00			
Parking Bus, Adj	1.00	1.00	1.00	1.00	1.00	1.00	1.00	1.00	1.00			
Adj Sat Flow, veh/h/ln	0	1863	1863	0	1863	1863	1863	1863	1863			
Adj Flow Rate, veh/h	0	1002	654	0	972	105	203	0	73			
Adj No. of Lanes	0	2	1	0	3	1	2	0	1			
Peak Hour Factor	0.96	0.96	0.96	0.96	0.96	0.96	0.96	0.96	0.96			
Percent Heavy Veh, %	0	2	2	0	2	2	2	2	2			
Cap, veh/h	0	2024	1096	0	2908	905	428	0	191			
Arrive On Green	0.00	0.57	0.57	0.00	0.57	0.57	0.12	0.00	0.12			
Sat Flow, veh/h	0	3632	1583	0	5253	1583	3548	0	1583			
Grp Volume(v), veh/h	0	1002	654	0	972	105	203	0	73			
Grp Sat Flow(s),veh/h/ln	0	1770	1583	0	1695	1583	1774	0	1583			
Q Serve(g_s), s	0.0	7.5	9.6	0.0	4.5	1.3	2.4	0.0	1.9			
Cycle Q Clear(g_c), s	0.0	7.5	9.6	0.0	4.5	1.3	2.4	0.0	1.9			
Prop In Lane	0.00		1.00	0.00		1.00	1.00		1.00			
Lane Grp Cap(c), veh/h	0	2024	1096	0	2908	905	428	0	191			
V/C Ratio(X)	0.00	0.50	0.60	0.00	0.33	0.12	0.47	0.00	0.38			
Avail Cap(c_a), veh/h	0	4083	2017	0	4141	1289	3531	0	1576			
HCM Platoon Ratio	1.00	1.00	1.00	1.00	1.00	1.00	1.00	1.00	1.00			
Upstream Filter(I)	0.00	1.00	1.00	0.00	1.00	1.00	1.00	0.00	1.00			
Uniform Delay (d), s/veh	0.0	5.7	3.6	0.0	5.0	4.3	18.1	0.0	17.9			
Incr Delay (d2), s/veh	0.0	0.2	0.5	0.0	0.1	0.1	0.8	0.0	1.3			
Initial Q Delay(d3),s/veh	0.0	0.0	0.0	0.0	0.0	0.0	0.0	0.0	0.0			
%ile BackOfQ(50%),veh/ln	0.0	3.7	5.8	0.0	2.1	0.6	1.2	0.0	0.9			
LnGrp Delay(d),s/veh	0.0	5.8	4.1	0.0	5.1	4.4	19.0	0.0	19.2			
LnGrp LOS		A	A		A	A	B		B			
Approach Vol, veh/h		1656			1077			276				
Approach Delay, s/veh		5.1			5.0			19.0				
Approach LOS		A			A			B				
Timer	1	2	3	4	5	6	7	8				
Assigned Phs		2				6		8				
Phs Duration (G+Y+Rc), s		32.8				32.8		11.4				
Change Period (Y+Rc), s		7.5				7.5		6.1				
Max Green Setting (Gmax), s		51.0				36.0		44.0				
Max Q Clear Time (g_c+I1), s		11.6				6.5		4.4				
Green Ext Time (p_c), s		13.7				8.5		1.0				
Intersection Summary												
HCM 2010 Ctrl Delay			6.4									
HCM 2010 LOS			A									
Notes												

HCM 2010 Signalized Intersection Summary
 1: Highway 76 & Olive Hill Road/Camino Del Rey

Existing + Cumulative + Project PM
 07/10/2019

												
Movement	EBL	EBT	EBR	WBL	WBT	WBR	NBL	NBT	NBR	SBL	SBT	SBR
Lane Configurations	 							  		 	  	
Traffic Volume (veh/h)	140	252	350	245	217	414	272	3091	344	344	1949	176
Future Volume (veh/h)	140	252	350	245	217	414	272	3091	344	344	1949	176
Number	7	4	14	3	8	18	5	2	12	1	6	16
Initial Q (Qb), veh	0	0	0	0	0	0	0	0	0	0	0	0
Ped-Bike Adj(A_pbT)	1.00		1.00	1.00		1.00	1.00		1.00	1.00		1.00
Parking Bus, Adj	1.00	1.00	1.00	1.00	1.00	1.00	1.00	1.00	1.00	1.00	1.00	1.00
Adj Sat Flow, veh/h/ln	1863	1863	1863	1863	1863	1863	1863	1863	1863	1863	1863	1863
Adj Flow Rate, veh/h	143	257	357	250	221	422	278	3154	351	351	1989	180
Adj No. of Lanes	2	1	1	1	1	1	1	3	1	2	3	1
Peak Hour Factor	0.98	0.98	0.98	0.98	0.98	0.98	0.98	0.98	0.98	0.98	0.98	0.98
Percent Heavy Veh, %	2	2	2	2	2	2	2	2	2	2	2	2
Cap, veh/h	372	201	171	423	444	378	240	2174	677	384	2054	640
Arrive On Green	0.11	0.11	0.11	0.24	0.24	0.24	0.14	0.43	0.43	0.11	0.40	0.40
Sat Flow, veh/h	3442	1863	1583	1774	1863	1583	1774	5085	1583	3442	5085	1583
Grp Volume(v), veh/h	143	257	357	250	221	422	278	3154	351	351	1989	180
Grp Sat Flow(s),veh/h/ln	1721	1863	1583	1774	1863	1583	1774	1695	1583	1721	1695	1583
Q Serve(g_s), s	8.6	24.0	24.0	27.7	22.8	53.0	30.0	95.0	36.2	22.4	85.1	17.0
Cycle Q Clear(g_c), s	8.6	24.0	24.0	27.7	22.8	53.0	30.0	95.0	36.2	22.4	85.1	17.0
Prop In Lane	1.00		1.00	1.00		1.00	1.00		1.00	1.00		1.00
Lane Grp Cap(c), veh/h	372	201	171	423	444	378	240	2174	677	384	2054	640
V/C Ratio(X)	0.38	1.28	2.09	0.59	0.50	1.12	1.16	1.45	0.52	0.92	0.97	0.28
Avail Cap(c_a), veh/h	372	201	171	423	444	378	240	2174	677	418	2060	641
HCM Platoon Ratio	1.00	1.00	1.00	1.00	1.00	1.00	1.00	1.00	1.00	1.00	1.00	1.00
Upstream Filter(I)	1.00	1.00	1.00	1.00	1.00	1.00	1.00	1.00	1.00	1.00	1.00	1.00
Uniform Delay (d), s/veh	92.2	99.1	99.1	75.0	73.1	84.6	96.1	63.6	46.8	97.7	64.8	44.5
Incr Delay (d2), s/veh	0.7	157.3	508.6	2.2	0.9	81.9	108.4	205.4	0.7	23.4	13.1	0.2
Initial Q Delay(d3),s/veh	0.0	0.0	0.0	0.0	0.0	0.0	0.0	0.0	0.0	0.0	0.0	0.0
%ile BackOfQ(50%),veh/ln	4.1	21.1	34.7	13.9	11.8	31.8	21.9	85.8	16.0	11.9	42.3	7.5
LnGrp Delay(d),s/veh	92.9	256.4	607.7	77.1	73.9	166.5	204.4	268.9	47.5	121.1	77.9	44.8
LnGrp LOS	F	F	F	E	E	F	F	F	D	F	E	D
Approach Vol, veh/h		757			893			3783			2520	
Approach Delay, s/veh		391.2			118.6			243.7			81.6	
Approach LOS		F			F			F			F	
Timer	1	2	3	4	5	6	7	8				
Assigned Phs	1	2		4	5	6		8				
Phs Duration (G+Y+Rc), s	30.5	102.5		30.1	35.7	97.2		59.1				
Change Period (Y+Rc), s	* 5.7	7.5		6.1	* 5.7	7.5		6.1				
Max Green Setting (Gmax), s	* 27	90.0		24.0	* 30	90.0		53.0				
Max Q Clear Time (g_c+I1), s	24.4	97.0		26.0	32.0	87.1		55.0				
Green Ext Time (p_c), s	0.3	0.0		0.0	0.0	2.7		0.0				
Intersection Summary												
HCM 2010 Ctrl Delay	192.3											
HCM 2010 LOS	F											
Notes												

Intersection						
Int Delay, s/veh	0					
Movement	EBL	EBR	NBL	NBT	SBT	SBR
Lane Configurations	↔		↔	↑	↑	↔
Traffic Vol, veh/h	745	213	196	152	103	830
Future Vol, veh/h	745	213	196	152	103	830
Conflicting Peds, #/hr	0	0	0	0	0	0
Sign Control	Free	Free	Stop	Stop	Free	Free
RT Channelized	-	Free	-	None	-	Free
Storage Length	0	-	150	-	-	150
Veh in Median Storage, #	-	-	-	0	0	-
Grade, %	0	-	-	0	0	-
Peak Hour Factor	97	97	97	97	97	97
Heavy Vehicles, %	2	2	2	2	2	2
Mvmt Flow	768	220	202	157	106	856

Major/Minor	Minor2	Major2		
Conflicting Flow All	106	106	-	0
Stage 1	106	106	-	-
Stage 2	0	0	-	-
Critical Hdwy	6.42	6.52	-	-
Critical Hdwy Stg 1	5.42	5.52	-	-
Critical Hdwy Stg 2	-	-	-	-
Follow-up Hdwy	3.518	4.018	-	-
Pot Cap-1 Maneuver	892	784	-	0
Stage 1	918	807	-	0
Stage 2	-	-	-	0
Platoon blocked, %			-	
Mov Cap-1 Maneuver	892	0	-	-
Mov Cap-2 Maneuver	892	0	-	-
Stage 1	918	0	-	-
Stage 2	-	0	-	-

Approach	NB	SB
HCM Control Delay, s		0
HCM LOS	-	

Minor Lane/Major Mvmt	NBLn1	NBLn2	SBT
Capacity (veh/h)	892	-	-
HCM Lane V/C Ratio	0.227	-	-
HCM Control Delay (s)	10.2	-	-
HCM Lane LOS	B	-	-
HCM 95th %tile Q(veh)	0.9	-	-

Intersection						
Int Delay, s/veh	6.6					
Movement	EBL	EBT	WBT	WBR	SBL	SBR
Lane Configurations		↔	↔		↔	↔
Traffic Vol, veh/h	289	479	603	47	20	198
Future Vol, veh/h	289	479	603	47	20	198
Conflicting Peds, #/hr	0	0	0	0	0	0
Sign Control	Free	Free	Free	Free	Stop	Stop
RT Channelized	-	None	-	None	-	Stop
Storage Length	-	-	-	-	0	100
Veh in Median Storage, #	-	0	0	-	0	-
Grade, %	-	0	0	-	0	-
Peak Hour Factor	91	91	91	91	91	91
Heavy Vehicles, %	2	2	2	2	2	2
Mvmt Flow	318	526	663	52	22	218

























Major/Minor	Major1	Major2	Minor2		
Conflicting Flow All	715	0	-	0	1851 689
Stage 1	-	-	-	-	689 -
Stage 2	-	-	-	-	1162 -
Critical Hdwy	4.12	-	-	-	6.42 6.22
Critical Hdwy Stg 1	-	-	-	-	5.42 -
Critical Hdwy Stg 2	-	-	-	-	5.42 -
Follow-up Hdwy	2.218	-	-	-	3.518 3.318
Pot Cap-1 Maneuver	885	-	-	-	82 446
Stage 1	-	-	-	-	498 -
Stage 2	-	-	-	-	298 -
Platoon blocked, %		-	-	-	
Mov Cap-1 Maneuver	885	-	-	-	40 446
Mov Cap-2 Maneuver	-	-	-	-	40 -
Stage 1	-	-	-	-	245 -
Stage 2	-	-	-	-	298 -

Approach	EB	WB	SB
HCM Control Delay, s	4.3	0	34.6
HCM LOS			D

Minor Lane/Major Mvmt	EBL	EBT	WBT	WBR	SBLn1	SBLn2
Capacity (veh/h)	885	-	-	-	40	446
HCM Lane V/C Ratio	0.359	-	-	-	0.549	0.488
HCM Control Delay (s)	11.3	0	-	-	174	20.5
HCM Lane LOS	B	A	-	-	F	C
HCM 95th %tile Q(veh)	1.6	-	-	-	2	2.6

HCM 2010 Signalized Intersection Summary
4: Old Highway 395 & Highway 76

Existing + Cumulative + Project PM
07/10/2019

												
Movement	EBL	EBT	EBR	WBL	WBT	WBR	NBL	NBT	NBR	SBL	SBT	SBR
Lane Configurations												
Traffic Volume (veh/h)	211	1304	216	164	1416	371	275	352	151	320	259	96
Future Volume (veh/h)	211	1304	216	164	1416	371	275	352	151	320	259	96
Number	5	2	12	1	6	16	3	8	18	7	4	14
Initial Q (Qb), veh	0	0	0	0	0	0	0	0	0	0	0	0
Ped-Bike Adj(A_pbT)	1.00		1.00	1.00		1.00	1.00		1.00	1.00		1.00
Parking Bus, Adj	1.00	1.00	1.00	1.00	1.00	1.00	1.00	1.00	1.00	1.00	1.00	1.00
Adj Sat Flow, veh/h/ln	1863	1863	1863	1863	1863	1863	1863	1863	1863	1863	1863	1900
Adj Flow Rate, veh/h	224	1387	127	174	1506	0	293	374	85	340	276	97
Adj No. of Lanes	1	3	1	1	2	1	1	1	1	2	1	0
Peak Hour Factor	0.94	0.94	0.94	0.94	0.94	0.94	0.94	0.94	0.94	0.94	0.94	0.94
Percent Heavy Veh, %	2	2	2	2	2	2	2	2	2	2	2	2
Cap, veh/h	241	1869	582	193	1206	860	279	322	447	696	300	105
Arrive On Green	0.14	0.37	0.37	0.11	0.34	0.00	0.16	0.17	0.17	0.20	0.23	0.23
Sat Flow, veh/h	1774	5085	1583	1774	3539	1583	1774	1863	1583	3442	1318	463
Grp Volume(v), veh/h	224	1387	127	174	1506	0	293	374	85	340	0	373
Grp Sat Flow(s),veh/h/ln	1774	1695	1583	1774	1770	1583	1774	1863	1583	1721	0	1781
Q Serve(g_s), s	23.8	45.2	10.5	18.5	65.0	0.0	30.0	33.0	4.4	16.7	0.0	39.0
Cycle Q Clear(g_c), s	23.8	45.2	10.5	18.5	65.0	0.0	30.0	33.0	4.4	16.7	0.0	39.0
Prop In Lane	1.00		1.00	1.00		1.00	1.00		1.00	1.00		0.26
Lane Grp Cap(c), veh/h	241	1869	582	193	1206	860	279	322	447	696	0	405
V/C Ratio(X)	0.93	0.74	0.22	0.90	1.25	0.00	1.05	1.16	0.19	0.49	0.00	0.92
Avail Cap(c_a), veh/h	251	1869	582	288	1206	860	279	322	447	866	0	598
HCM Platoon Ratio	1.00	1.00	1.00	1.00	1.00	1.00	1.00	1.00	1.00	1.00	1.00	1.00
Upstream Filter(I)	1.00	1.00	1.00	1.00	1.00	0.00	1.00	1.00	1.00	1.00	0.00	1.00
Uniform Delay (d), s/veh	81.5	52.4	41.5	83.9	62.8	0.0	80.3	78.8	22.6	67.3	0.0	72.0
Incr Delay (d2), s/veh	37.5	1.6	0.2	21.3	118.8	0.0	67.5	100.9	0.2	0.5	0.0	14.9
Initial Q Delay(d3),s/veh	0.0	0.0	0.0	0.0	0.0	0.0	0.0	0.0	0.0	0.0	0.0	0.0
%ile BackOfQ(50%),veh/ln	14.2	21.5	4.6	10.2	51.6	0.0	19.9	26.0	2.0	8.0	0.0	20.9
LnGrp Delay(d),s/veh	119.0	54.1	41.6	105.2	181.6	0.0	147.9	179.8	22.8	67.8	0.0	86.9
LnGrp LOS	F	D	D	F	F		F	F	C	E		F
Approach Vol, veh/h		1738			1680			752			713	
Approach Delay, s/veh		61.5			173.7			149.6			77.8	
Approach LOS		E			F			F			E	
Timer	1	2	3	4	5	6	7	8				
Assigned Phs	1	2	3	4	5	6	7	8				
Phs Duration (G+Y+Rc), s	26.5	77.6	35.7	50.9	31.6	72.5	46.1	40.5				
Change Period (Y+Rc), s	* 5.7	7.5	* 5.7	7.5	* 5.7	7.5	7.5	* 7.5				
Max Green Setting (Gmax), s	* 31	60.0	* 30	64.0	* 27	65.0	48.0	* 33				
Max Q Clear Time (g_c+I1), s	20.5	47.2	32.0	41.0	25.8	67.0	18.7	35.0				
Green Ext Time (p_c), s	0.3	8.0	0.0	2.4	0.1	0.0	1.2	0.0				
Intersection Summary												
HCM 2010 Ctrl Delay	116.1											
HCM 2010 LOS	F											
Notes												

Intersection						
Int Delay, s/veh	66.1					
Movement	WBL	WBR	NBT	NBR	SBL	SBT
Lane Configurations						
Traffic Vol, veh/h	210	140	514	263	119	501
Future Vol, veh/h	210	140	514	263	119	501
Conflicting Peds, #/hr	0	0	0	0	0	0
Sign Control	Stop	Stop	Free	Free	Free	Free
RT Channelized	-	None	-	None	-	None
Storage Length	0	385	-	-	-	-
Veh in Median Storage, #	0	-	0	-	-	0
Grade, %	0	-	0	-	-	0
Peak Hour Factor	95	95	95	95	95	95
Heavy Vehicles, %	2	2	2	2	2	2
Mvmt Flow	221	147	541	277	125	527

Major/Minor	Minor1	Major1	Major2		
Conflicting Flow All	1457	680	0	0	818
Stage 1	680	-	-	-	-
Stage 2	777	-	-	-	-
Critical Hdwy	6.42	6.22	-	-	4.12
Critical Hdwy Stg 1	5.42	-	-	-	-
Critical Hdwy Stg 2	5.42	-	-	-	-
Follow-up Hdwy	3.518	3.318	-	-	2.218
Pot Cap-1 Maneuver	~ 143	451	-	-	810
Stage 1	503	-	-	-	-
Stage 2	453	-	-	-	-
Platoon blocked, %			-	-	-
Mov Cap-1 Maneuver	~ 112	451	-	-	810
Mov Cap-2 Maneuver	~ 112	-	-	-	-
Stage 1	393	-	-	-	-
Stage 2	453	-	-	-	-

Approach	WB	NB	SB
HCM Control Delay, s\$	326.5	0	2
HCM LOS	F		

Minor Lane/Major Mvmt	NBT	NBR	WBLn1	WBLn2	SBL	SBT
Capacity (veh/h)	-	-	112	451	810	-
HCM Lane V/C Ratio	-	-	1.974	0.327	0.155	-
HCM Control Delay (s)	-	-	\$ 532.9	16.8	10.3	0
HCM Lane LOS	-	-	F	C	B	A
HCM 95th %tile Q(veh)	-	-	18.2	1.4	0.5	-

Notes
 -: Volume exceeds capacity \$: Delay exceeds 300s +: Computation Not Defined *: All major volume in platoon

Intersection												
Int Delay, s/veh	2.1											
Movement	EBL	EBT	EBR	WBL	WBT	WBR	NBL	NBT	NBR	SBL	SBT	SBR
Lane Configurations		↕	↗		↕	↗	↗	↗		↗	↕↗	
Traffic Vol, veh/h	166	95	78	280	58	164	187	407	458	257	267	148
Future Vol, veh/h	166	95	78	280	58	164	187	407	458	257	267	148
Conflicting Peds, #/hr	0	0	0	0	0	0	0	0	0	0	0	0
Sign Control	Stop	Stop	Stop	Stop	Stop	Stop	Free	Free	Free	Free	Free	Free
RT Channelized	-	-	Stop	-	-	Stop	-	-	None	-	-	None
Storage Length	-	-	25	-	-	50	210	-	-	200	-	530
Veh in Median Storage, #	-	0	-	-	0	-	-	0	-	-	0	-
Grade, %	-	0	-	-	0	-	-	0	-	-	0	-
Peak Hour Factor	86	86	86	86	86	86	86	86	86	86	86	86
Heavy Vehicles, %	2	2	2	2	2	2	2	2	2	2	2	2
Mvmt Flow	193	110	91	326	67	191	217	473	533	299	310	172

Major/Minor	Minor2		Minor1		Major1		Major2					
Conflicting Flow All	2201	2434	241	1982	2254	740	482	0	0	1006	0	0
Stage 1	994	994	-	1174	1174	-	-	-	-	-	-	-
Stage 2	1207	1440	-	808	1080	-	-	-	-	-	-	-
Critical Hdwy	7.33	6.53	6.93	7.33	6.53	6.23	4.13	-	-	4.13	-	-
Critical Hdwy Stg 1	6.53	5.53	-	6.13	5.53	-	-	-	-	-	-	-
Critical Hdwy Stg 2	6.13	5.53	-	6.53	5.53	-	-	-	-	-	-	-
Follow-up Hdwy	3.519	4.019	3.319	3.519	4.019	3.319	2.219	-	-	2.219	-	-
Pot Cap-1 Maneuver	~ 28	~ 32	761	~ 41	~ 41	416	1079	-	-	686	-	-
Stage 1	264	322	-	~ 233	265	-	-	-	-	-	-	-
Stage 2	223	197	-	342	293	-	-	-	-	-	-	-
Platoon blocked, %								-	-	-	-	-
Mov Cap-1 Maneuver	-	~ 14	761	-	~ 18	416	1079	-	-	686	-	-
Mov Cap-2 Maneuver	-	~ 14	-	-	~ 18	-	-	-	-	-	-	-
Stage 1	211	182	-	~ 186	212	-	-	-	-	-	-	-
Stage 2	~ 66	157	-	~ 67	165	-	-	-	-	-	-	-

Approach	EB		WB		NB		SB	
HCM Control Delay, s					1.6		5.4	
HCM LOS	-		-					

Minor Lane/Major Mvmt	NBL	NBT	NBR	EBLn1	EBLn2	WBLn1	WBLn2	SBL	SBT	SBR
Capacity (veh/h)	1079	-	-	-	761	-	416	686	-	-
HCM Lane V/C Ratio	0.202	-	-	-	0.119	-	0.458	0.436	-	-
HCM Control Delay (s)	9.2	-	-	-	10.4	-	20.8	14.2	-	-
HCM Lane LOS	A	-	-	-	B	-	C	B	-	-
HCM 95th %tile Q(veh)	0.8	-	-	-	0.4	-	2.3	2.2	-	-

Notes
 -: Volume exceeds capacity \$: Delay exceeds 300s +: Computation Not Defined *: All major volume in platoon

Intersection												
Int Delay, s/veh	27.2											
Movement	EBL	EBT	EBR	WBL	WBT	WBR	NBL	NBT	NBR	SBL	SBT	SBR
Lane Configurations		↑	↗	↘	↑						↑	↗
Traffic Vol, veh/h	0	317	388	46	797	0	0	0	0	142	6	275
Future Vol, veh/h	0	317	388	46	797	0	0	0	0	142	6	275
Conflicting Peds, #/hr	0	0	0	0	0	0	0	0	0	0	0	0
Sign Control	Free	Free	Free	Free	Free	Free	Stop	Stop	Stop	Stop	Stop	Stop
RT Channelized	-	-	Free	-	-	None	-	-	None	-	-	Yield
Storage Length	-	-	390	55	-	-	-	-	-	-	-	32
Veh in Median Storage, #	-	0	-	-	0	-	-	-	-	-	0	-
Grade, %	-	0	-	-	0	-	-	0	-	-	0	-
Peak Hour Factor	88	88	88	88	88	88	88	88	88	88	88	88
Heavy Vehicles, %	2	2	2	2	2	2	2	2	2	2	2	2
Mvmt Flow	0	360	441	52	906	0	0	0	0	161	7	313

Major/Minor	Major1			Major2			Minor2			
Conflicting Flow All	-	0	-	360	0	0		1370	1370	906
Stage 1	-	-	-	-	-	-		1010	1010	-
Stage 2	-	-	-	-	-	-		360	360	-
Critical Hdwy	-	-	-	4.12	-	-		6.42	6.52	6.22
Critical Hdwy Stg 1	-	-	-	-	-	-		5.42	5.52	-
Critical Hdwy Stg 2	-	-	-	-	-	-		5.42	5.52	-
Follow-up Hdwy	-	-	-	2.218	-	-		3.518	4.018	3.318
Pot Cap-1 Maneuver	0	-	0	1199	-	0		~ 161	146	334
Stage 1	0	-	0	-	-	0		352	317	-
Stage 2	0	-	0	-	-	0		706	626	-
Platoon blocked, %		-			-					
Mov Cap-1 Maneuver	-	-	-	1199	-	-		~ 154	0	334
Mov Cap-2 Maneuver	-	-	-	-	-	-		~ 154	0	-
Stage 1	-	-	-	-	-	-		337	0	-
Stage 2	-	-	-	-	-	-		706	0	-

Approach	EB	WB	SB
HCM Control Delay, s	0	0.4	101
HCM LOS			F

Minor Lane/Major Mvmt	EBT	WBL	WBT	SBLn1	SBLn2
Capacity (veh/h)	-	1199	-	154	334
HCM Lane V/C Ratio	-	0.044	-	1.092	0.936
HCM Control Delay (s)	-	8.1	-	158.3	70.2
HCM Lane LOS	-	A	-	F	F
HCM 95th %tile Q(veh)	-	0.1	-	8.9	9.6

Notes
 -: Volume exceeds capacity \$: Delay exceeds 300s +: Computation Not Defined *: All major volume in platoon

Intersection												
Int Delay, s/veh	211											
Movement	EBL	EBT	EBR	WBL	WBT	WBR	NBL	NBT	NBR	SBL	SBT	SBR
Lane Configurations		↑	↑		↑	↑	↑		↑			
Traffic Vol, veh/h	0	352	130	0	346	98	599	0	79	0	0	0
Future Vol, veh/h	0	352	130	0	346	98	599	0	79	0	0	0
Conflicting Peds, #/hr	0	0	0	0	0	0	0	0	0	0	0	0
Sign Control	Free	Free	Free	Free	Free	Free	Stop	Stop	Stop	Stop	Stop	Stop
RT Channelized	-	-	Free	-	-	Free	-	-	Stop	-	-	None
Storage Length	-	-	200	-	-	100	0	-	150	-	-	-
Veh in Median Storage, #	-	0	-	-	0	-	-	0	-	-	16965	-
Grade, %	-	0	-	-	0	-	-	0	-	-	0	-
Peak Hour Factor	86	86	86	86	86	86	86	86	86	86	86	86
Heavy Vehicles, %	2	2	2	2	2	2	2	2	2	2	2	2
Mvmt Flow	0	409	151	0	402	114	697	0	92	0	0	0

Major/Minor	Major1		Major2		Minor1	
Conflicting Flow All	-	0	-	-	0	811
Stage 1	-	-	-	-	-	409
Stage 2	-	-	-	-	-	402
Critical Hdwy	-	-	-	-	-	6.42
Critical Hdwy Stg 1	-	-	-	-	-	5.42
Critical Hdwy Stg 2	-	-	-	-	-	5.42
Follow-up Hdwy	-	-	-	-	-	3.518
Pot Cap-1 Maneuver	0	-	0	0	-	349
Stage 1	0	-	0	0	-	671
Stage 2	0	-	0	0	-	676
Platoon blocked, %	-	-	-	-	-	-
Mov Cap-1 Maneuver	-	-	-	-	-	349
Mov Cap-2 Maneuver	-	-	-	-	-	349
Stage 1	-	-	-	-	-	671
Stage 2	-	-	-	-	-	676

Approach	EB	WB	NB
HCM Control Delay, s	0	0	\$ 428.2
HCM LOS			F

Minor Lane/Major Mvmt	NBLn1	NBLn2	EBT	WBT
Capacity (veh/h)	349	642	-	-
HCM Lane V/C Ratio	1.996	0.143	-	-
HCM Control Delay (s)	\$ 483.2	11.5	-	-
HCM Lane LOS	F	B	-	-
HCM 95th %tile Q(veh)	48.8	0.5	-	-

Notes
 -: Volume exceeds capacity \$: Delay exceeds 300s +: Computation Not Defined *: All major volume in platoon

Intersection						
Int Delay, s/veh	22.9					
Movement	EBL	EBR	NBL	NBT	SBT	SBR
Lane Configurations	Y		Y	↑	↑	Y
Traffic Vol, veh/h	38	212	450	424	324	83
Future Vol, veh/h	38	212	450	424	324	83
Conflicting Peds, #/hr	0	0	0	0	0	0
Sign Control	Stop	Stop	Free	Free	Free	Free
RT Channelized	-	None	-	None	-	None
Storage Length	0	-	110	-	-	50
Veh in Median Storage, #	0	-	-	0	0	-
Grade, %	0	-	-	0	0	-
Peak Hour Factor	94	94	94	94	94	94
Heavy Vehicles, %	2	2	2	2	2	2
Mvmt Flow	40	226	479	451	345	88

Major/Minor	Minor2	Major1	Major2			
Conflicting Flow All	1754	345	433	0	-	0
Stage 1	345	-	-	-	-	-
Stage 2	1409	-	-	-	-	-
Critical Hdwy	6.42	6.22	4.12	-	-	-
Critical Hdwy Stg 1	5.42	-	-	-	-	-
Critical Hdwy Stg 2	5.42	-	-	-	-	-
Follow-up Hdwy	3.518	3.318	2.218	-	-	-
Pot Cap-1 Maneuver	94	698	1127	-	-	-
Stage 1	717	-	-	-	-	-
Stage 2	226	-	-	-	-	-
Platoon blocked, %				-	-	-
Mov Cap-1 Maneuver	54	698	1127	-	-	-
Mov Cap-2 Maneuver	54	-	-	-	-	-
Stage 1	412	-	-	-	-	-
Stage 2	226	-	-	-	-	-

Approach	EB	NB	SB
HCM Control Delay, s	121.1	5.4	0
HCM LOS	F		

Minor Lane/Major Mvmt	NBL	NBT	EBLn1	SBT	SBR
Capacity (veh/h)	1127	-	248	-	-
HCM Lane V/C Ratio	0.425	-	1.072	-	-
HCM Control Delay (s)	10.5	-	121.1	-	-
HCM Lane LOS	B	-	F	-	-
HCM 95th %tile Q(veh)	2.2	-	11.2	-	-













Intersection						
Int Delay, s/veh	224.4					
Movement	WBL	WBR	NBT	NBR	SBL	SBT
Lane Configurations	↔		↔		↔	↔
Traffic Vol, veh/h	213	112	700	377	158	439
Future Vol, veh/h	213	112	700	377	158	439
Conflicting Peds, #/hr	0	0	0	0	0	0
Sign Control	Stop	Stop	Free	Free	Free	Free
RT Channelized	-	None	-	None	-	None
Storage Length	0	-	-	-	165	-
Veh in Median Storage, #	0	-	0	-	-	0
Grade, %	0	-	0	-	-	0
Peak Hour Factor	93	93	93	93	93	93
Heavy Vehicles, %	2	2	2	2	2	2
Mvmt Flow	229	120	753	405	170	472

Major/Minor	Minor1	Major1	Major2		
Conflicting Flow All	1768	956	0	0	1158
Stage 1	956	-	-	-	-
Stage 2	812	-	-	-	-
Critical Hdwy	6.42	6.22	-	-	4.12
Critical Hdwy Stg 1	5.42	-	-	-	-
Critical Hdwy Stg 2	5.42	-	-	-	-
Follow-up Hdwy	3.518	3.318	-	-	2.218
Pot Cap-1 Maneuver	~ 92	313	-	-	603
Stage 1	373	-	-	-	-
Stage 2	437	-	-	-	-
Platoon blocked, %			-	-	-
Mov Cap-1 Maneuver	~ 66	313	-	-	603
Mov Cap-2 Maneuver	~ 66	-	-	-	-
Stage 1	268	-	-	-	-
Stage 2	437	-	-	-	-

Approach	WB	NB	SB
HCM Control Delay, \$	1374.1	0	3.5
HCM LOS	F		

Minor Lane/Major Mvmt	NBT	NBRWBLn1	SBL	SBT
Capacity (veh/h)	-	-	91	603
HCM Lane V/C Ratio	-	-	3.84	0.282
HCM Control Delay (s)	-	\$ 1374.1	13.3	-
HCM Lane LOS	-	-	F	B
HCM 95th %tile Q(veh)	-	-	36	1.2

Notes
 -: Volume exceeds capacity \$: Delay exceeds 300s +: Computation Not Defined *: All major volume in platoon

								
Movement	EBL	EBR	NBL	NBT	SBT	SBR		
Lane Configurations								
Traffic Volume (veh/h)	679	250	277	390	276	382		
Future Volume (veh/h)	679	250	277	390	276	382		
Number	7	14	5	2	6	16		
Initial Q (Qb), veh	0	0	0	0	0	0		
Ped-Bike Adj(A_pbT)	1.00	1.00	1.00			1.00		
Parking Bus, Adj	1.00	1.00	1.00	1.00	1.00	1.00		
Adj Sat Flow, veh/h/ln	1863	1863	1863	1863	1863	1863		
Adj Flow Rate, veh/h	707	260	289	406	288	398		
Adj No. of Lanes	1	1	1	1	1	1		
Peak Hour Factor	0.96	0.96	0.96	0.96	0.96	0.96		
Percent Heavy Veh, %	2	2	2	2	2	2		
Cap, veh/h	446	708	347	1106	598	508		
Arrive On Green	0.25	0.25	0.20	0.59	0.32	0.32		
Sat Flow, veh/h	1774	1583	1774	1863	1863	1583		
Grp Volume(v), veh/h	707	260	289	406	288	398		
Grp Sat Flow(s),veh/h/ln	1774	1583	1774	1863	1863	1583		
Q Serve(g_s), s	13.0	5.6	8.1	5.9	6.4	11.8		
Cycle Q Clear(g_c), s	13.0	5.6	8.1	5.9	6.4	11.8		
Prop In Lane	1.00	1.00	1.00			1.00		
Lane Grp Cap(c), veh/h	446	708	347	1106	598	508		
V/C Ratio(X)	1.58	0.37	0.83	0.37	0.48	0.78		
Avail Cap(c_a), veh/h	446	708	412	1585	1009	858		
HCM Platoon Ratio	1.00	1.00	1.00	1.00	1.00	1.00		
Upstream Filter(I)	1.00	1.00	1.00	1.00	1.00	1.00		
Uniform Delay (d), s/veh	19.3	9.5	20.0	5.5	14.1	15.9		
Incr Delay (d2), s/veh	273.7	0.3	11.9	0.2	0.6	2.7		
Initial Q Delay(d3),s/veh	0.0	0.0	0.0	0.0	0.0	0.0		
%ile BackOfQ(50%),veh/ln	40.1	5.8	5.1	3.0	3.4	5.5		
LnGrp Delay(d),s/veh	293.1	9.8	31.9	5.7	14.7	18.6		
LnGrp LOS	F	A	C	A	B	B		
Approach Vol, veh/h	967			695	686			
Approach Delay, s/veh	216.9			16.6	17.0			
Approach LOS	F			B	B			
Timer	1	2	3	4	5	6	7	8
Assigned Phs		2		4	5	6		
Phs Duration (G+Y+Rc), s		34.7		17.0	14.1	20.6		
Change Period (Y+Rc), s		4.0		4.0	4.0	4.0		
Max Green Setting (Gmax), s		44.0		13.0	12.0	28.0		
Max Q Clear Time (g_c+I1), s		7.9		15.0	10.1	13.8		
Green Ext Time (p_c), s		2.8		0.0	0.2	2.8		
Intersection Summary								
HCM 2010 Ctrl Delay			99.2					
HCM 2010 LOS			F					

Intersection												
Int Delay, s/veh	4.3											
Movement	EBL	EBT	EBR	WBL	WBT	WBR	NBL	NBT	NBR	SBL	SBT	SBR
Lane Configurations		↕			↕			↕			↕	
Traffic Vol, veh/h	11	4	51	9	3	8	97	110	8	34	135	11
Future Vol, veh/h	11	4	51	9	3	8	97	110	8	34	135	11
Conflicting Peds, #/hr	0	0	0	0	0	0	0	0	0	0	0	0
Sign Control	Stop	Stop	Stop	Stop	Stop	Stop	Free	Free	Free	Free	Free	Free
RT Channelized	-	-	None	-	-	None	-	-	None	-	-	None
Storage Length	-	-	-	-	-	-	-	-	-	-	-	-
Veh in Median Storage, #	-	0	-	-	0	-	-	0	-	-	0	-
Grade, %	-	0	-	-	0	-	-	0	-	-	0	-
Peak Hour Factor	78	78	78	78	78	78	78	78	78	78	78	78
Heavy Vehicles, %	2	2	2	2	2	2	2	2	2	2	2	2
Mvmt Flow	14	5	65	12	4	10	124	141	10	44	173	14

Major/Minor	Minor2		Minor1		Major1		Major2					
Conflicting Flow All	669	667	180	697	669	146	187	0	0	151	0	0
Stage 1	268	268	-	394	394	-	-	-	-	-	-	-
Stage 2	401	399	-	303	275	-	-	-	-	-	-	-
Critical Hdwy	7.12	6.52	6.22	7.12	6.52	6.22	4.12	-	-	4.12	-	-
Critical Hdwy Stg 1	6.12	5.52	-	6.12	5.52	-	-	-	-	-	-	-
Critical Hdwy Stg 2	6.12	5.52	-	6.12	5.52	-	-	-	-	-	-	-
Follow-up Hdwy	3.518	4.018	3.318	3.518	4.018	3.318	2.218	-	-	2.218	-	-
Pot Cap-1 Maneuver	371	380	863	356	379	901	1387	-	-	1430	-	-
Stage 1	738	687	-	631	605	-	-	-	-	-	-	-
Stage 2	626	602	-	706	683	-	-	-	-	-	-	-
Platoon blocked, %								-	-	-	-	-
Mov Cap-1 Maneuver	328	331	863	293	330	901	1387	-	-	1430	-	-
Mov Cap-2 Maneuver	328	331	-	293	330	-	-	-	-	-	-	-
Stage 1	666	664	-	569	546	-	-	-	-	-	-	-
Stage 2	554	543	-	625	660	-	-	-	-	-	-	-

Approach	EB		WB		NB		SB	
HCM Control Delay, s	11.6		14.3		3.5		1.4	
HCM LOS	B		B					

Minor Lane/Major Mvmt	NBL	NBT	NBR	EBLn1WBLn1	SBL	SBT	SBR
Capacity (veh/h)	1387	-	-	630	411	1430	-
HCM Lane V/C Ratio	0.09	-	-	0.134	0.062	0.03	-
HCM Control Delay (s)	7.9	0	-	11.6	14.3	7.6	0
HCM Lane LOS	A	A	-	B	B	A	A
HCM 95th %tile Q(veh)	0.3	-	-	0.5	0.2	0.1	-

Intersection						
Int Delay, s/veh	6.8					
Movement	WBL	WBR	NBT	NBR	SBL	SBT
Lane Configurations	W	W	T	T	T	T
Traffic Vol, veh/h	115	123	77	93	75	64
Future Vol, veh/h	115	123	77	93	75	64
Conflicting Peds, #/hr	0	0	0	0	0	0
Sign Control	Stop	Stop	Free	Free	Free	Free
RT Channelized	-	None	-	None	-	None
Storage Length	0	-	-	-	-	-
Veh in Median Storage, #	0	-	0	-	-	0
Grade, %	0	-	0	-	-	0
Peak Hour Factor	87	87	87	87	87	87
Heavy Vehicles, %	2	2	2	2	2	2
Mvmt Flow	132	141	89	107	86	74

Major/Minor	Minor1	Major1	Major2		
Conflicting Flow All	389	143	0	0	196
Stage 1	143	-	-	-	-
Stage 2	246	-	-	-	-
Critical Hdwy	6.42	6.22	-	-	4.12
Critical Hdwy Stg 1	5.42	-	-	-	-
Critical Hdwy Stg 2	5.42	-	-	-	-
Follow-up Hdwy	3.518	3.318	-	-	2.218
Pot Cap-1 Maneuver	615	905	-	-	1377
Stage 1	884	-	-	-	-
Stage 2	795	-	-	-	-
Platoon blocked, %			-	-	-
Mov Cap-1 Maneuver	575	905	-	-	1377
Mov Cap-2 Maneuver	575	-	-	-	-
Stage 1	827	-	-	-	-
Stage 2	795	-	-	-	-

Approach	WB	NB	SB
HCM Control Delay, s	13.2	0	4.2
HCM LOS	B		

Minor Lane/Major Mvmt	NBT	NBRWBLn1	SBL	SBT
Capacity (veh/h)	-	-	709	1377
HCM Lane V/C Ratio	-	-	0.386	0.063
HCM Control Delay (s)	-	-	13.2	7.8
HCM Lane LOS	-	-	B	A
HCM 95th %tile Q(veh)	-	-	1.8	0.2

Intersection						
Int Delay, s/veh	6					
Movement	EBL	EBR	NBL	NBT	SBT	SBR
Lane Configurations	T		T		T	
Traffic Vol, veh/h	76	99	127	124	99	46
Future Vol, veh/h	76	99	127	124	99	46
Conflicting Peds, #/hr	0	0	0	0	0	0
Sign Control	Stop	Stop	Free	Free	Free	Free
RT Channelized	-	None	-	None	-	None
Storage Length	0	-	-	-	-	-
Veh in Median Storage, #	0	-	-	0	0	-
Grade, %	0	-	-	0	0	-
Peak Hour Factor	86	86	86	86	86	86
Heavy Vehicles, %	2	2	2	2	2	2
Mvmt Flow	88	115	148	144	115	53

Major/Minor	Minor2	Major1	Major2			
Conflicting Flow All	582	142	168	0	-	0
Stage 1	142	-	-	-	-	-
Stage 2	440	-	-	-	-	-
Critical Hdwy	6.42	6.22	4.12	-	-	-
Critical Hdwy Stg 1	5.42	-	-	-	-	-
Critical Hdwy Stg 2	5.42	-	-	-	-	-
Follow-up Hdwy	3.518	3.318	2.218	-	-	-
Pot Cap-1 Maneuver	475	906	1410	-	-	-
Stage 1	885	-	-	-	-	-
Stage 2	649	-	-	-	-	-
Platoon blocked, %				-	-	-
Mov Cap-1 Maneuver	421	906	1410	-	-	-
Mov Cap-2 Maneuver	421	-	-	-	-	-
Stage 1	784	-	-	-	-	-
Stage 2	649	-	-	-	-	-

Approach	EB	NB	SB
HCM Control Delay, s	14	4	0
HCM LOS	B		

Minor Lane/Major Mvmt	NBL	NBT	EBLn1	SBT	SBR
Capacity (veh/h)	1410	-	604	-	-
HCM Lane V/C Ratio	0.105	-	0.337	-	-
HCM Control Delay (s)	7.9	0	14	-	-
HCM Lane LOS	A	A	B	-	-
HCM 95th %tile Q(veh)	0.4	-	1.5	-	-

Intersection						
Int Delay, s/veh	7.7					
Movement	EBL	EBT	WBT	WBR	SBL	SBR
Lane Configurations						
Traffic Vol, veh/h	66	438	327	239	176	52
Future Vol, veh/h	66	438	327	239	176	52
Conflicting Peds, #/hr	0	0	0	0	0	0
Sign Control	Free	Free	Free	Free	Stop	Stop
RT Channelized	-	None	-	None	-	None
Storage Length	165	-	-	80	0	-
Veh in Median Storage, #	-	0	0	-	0	-
Grade, %	-	0	0	-	0	-
Peak Hour Factor	97	97	97	97	97	97
Heavy Vehicles, %	2	2	2	2	2	2
Mvmt Flow	68	452	337	246	181	54























Major/Minor	Major1	Major2	Minor2		
Conflicting Flow All	583	0	-	0	925 337
Stage 1	-	-	-	-	337 -
Stage 2	-	-	-	-	588 -
Critical Hdwy	4.12	-	-	-	6.42 6.22
Critical Hdwy Stg 1	-	-	-	-	5.42 -
Critical Hdwy Stg 2	-	-	-	-	5.42 -
Follow-up Hdwy	2.218	-	-	-	3.518 3.318
Pot Cap-1 Maneuver	991	-	-	-	299 705
Stage 1	-	-	-	-	723 -
Stage 2	-	-	-	-	555 -
Platoon blocked, %		-	-	-	
Mov Cap-1 Maneuver	991	-	-	-	278 705
Mov Cap-2 Maneuver	-	-	-	-	278 -
Stage 1	-	-	-	-	673 -
Stage 2	-	-	-	-	555 -

Approach	EB	WB	SB
HCM Control Delay, s	1.2	0	40.9
HCM LOS			E

Minor Lane/Major Mvmt	EBL	EBT	WBT	WBR	SBLn1
Capacity (veh/h)	991	-	-	-	323
HCM Lane V/C Ratio	0.069	-	-	-	0.728
HCM Control Delay (s)	8.9	-	-	-	40.9
HCM Lane LOS	A	-	-	-	E
HCM 95th %tile Q(veh)	0.2	-	-	-	5.4

HCM 2010 Signalized Intersection Summary
 16: SR-76 & Old River Rd/East Vista Way

Existing + Cumulative + Project PM
 07/10/2019

												
Movement	EBL	EBT	EBR	WBL	WBT	WBR	NBL	NBT	NBR	SBL	SBT	SBR
Lane Configurations												
Traffic Volume (veh/h)	26	73	166	196	106	890	190	2585	521	549	1948	26
Future Volume (veh/h)	26	73	166	196	106	890	190	2585	521	549	1948	26
Number	7	4	14	3	8	18	5	2	12	1	6	16
Initial Q (Qb), veh	0	0	0	0	0	0	0	0	0	0	0	0
Ped-Bike Adj(A_pbT)	1.00		1.00	1.00		1.00	1.00		1.00	1.00		1.00
Parking Bus, Adj	1.00	1.00	1.00	1.00	1.00	1.00	1.00	1.00	1.00	1.00	1.00	1.00
Adj Sat Flow, veh/h/ln	1900	1863	1900	1863	1863	1863	1863	1863	1863	1863	1863	1900
Adj Flow Rate, veh/h	27	76	173	157	176	927	198	2693	543	572	2029	27
Adj No. of Lanes	0	2	0	1	1	1	1	3	1	2	3	0
Peak Hour Factor	0.96	0.96	0.96	0.96	0.96	0.96	0.96	0.96	0.96	0.96	0.96	0.96
Percent Heavy Veh, %	2	2	2	2	2	2	2	2	2	2	2	2
Cap, veh/h	58	163	190	311	327	559	214	2067	644	612	2398	32
Arrive On Green	0.12	0.12	0.12	0.18	0.18	0.18	0.12	0.41	0.41	0.18	0.46	0.46
Sat Flow, veh/h	482	1357	1583	1774	1863	1583	1774	5085	1583	3442	5172	69
Grp Volume(v), veh/h	103	0	173	157	176	927	198	2693	543	572	1329	727
Grp Sat Flow(s),veh/h/ln	1839	0	1583	1774	1863	1583	1774	1695	1583	1721	1695	1851
Q Serve(g_s), s	11.3	0.0	23.4	17.3	18.6	38.0	23.9	88.0	67.1	35.5	74.9	75.1
Cycle Q Clear(g_c), s	11.3	0.0	23.4	17.3	18.6	38.0	23.9	88.0	67.1	35.5	74.9	75.1
Prop In Lane	0.26		1.00	1.00		1.00	1.00		1.00	1.00		0.04
Lane Grp Cap(c), veh/h	221	0	190	311	327	559	214	2067	644	612	1572	858
V/C Ratio(X)	0.47	0.00	0.91	0.50	0.54	1.66	0.93	1.30	0.84	0.94	0.85	0.85
Avail Cap(c_a), veh/h	255	0	219	311	327	559	246	2067	644	668	1572	858
HCM Platoon Ratio	1.00	1.00	1.00	1.00	1.00	1.00	1.00	1.00	1.00	1.00	1.00	1.00
Upstream Filter(I)	1.00	0.00	1.00	1.00	1.00	1.00	1.00	1.00	1.00	1.00	1.00	1.00
Uniform Delay (d), s/veh	88.8	0.0	94.1	80.7	81.3	70.0	94.2	64.2	58.0	87.8	51.2	51.3
Incr Delay (d2), s/veh	1.5	0.0	34.4	1.3	1.8	303.7	35.3	139.9	10.0	19.7	4.5	7.9
Initial Q Delay(d3),s/veh	0.0	0.0	0.0	0.0	0.0	0.0	0.0	0.0	0.0	0.0	0.0	0.0
%ile BackOfQ(50%),veh/ln	5.8	0.0	12.1	8.6	9.8	80.6	13.9	67.9	31.2	18.6	36.1	40.2
LnGrp Delay(d),s/veh	90.3	0.0	128.5	82.0	83.0	373.7	129.5	204.1	68.0	107.4	55.7	59.2
LnGrp LOS	F		F	F	F	F	F	F	E	F	E	E
Approach Vol, veh/h		276			1260			3434			2628	
Approach Delay, s/veh		114.2			296.8			178.3			67.9	
Approach LOS		F			F			F			E	
Timer	1	2	3	4	5	6	7	8				
Assigned Phs	1	2		4	5	6		8				
Phs Duration (G+Y+Rc), s	44.2	95.5		32.4	31.8	107.9		44.4				
Change Period (Y+Rc), s	* 5.7	7.5		6.4	* 5.7	7.5		6.4				
Max Green Setting (Gmax), s	* 42	88.0		30.0	* 30	87.0		38.0				
Max Q Clear Time (g_c+I1), s	37.5	90.0		25.4	25.9	77.1		40.0				
Green Ext Time (p_c), s	1.0	0.0		0.6	0.2	8.2		0.0				
Intersection Summary												
HCM 2010 Ctrl Delay			157.4									
HCM 2010 LOS			F									
Notes												

HCM 2010 Signalized Intersection Summary
 17: SR-76 & N River Rd

Existing + Cumulative + Project PM
 07/10/2019



Movement	EBL	EBR	NBL	NBT	SBT	SBR		
Lane Configurations								
Traffic Volume (veh/h)	349	220	105	3379	2349	186		
Future Volume (veh/h)	349	220	105	3379	2349	186		
Number	7	14	5	2	6	16		
Initial Q (Qb), veh	0	0	0	0	0	0		
Ped-Bike Adj(A_pbT)	1.00	1.00	1.00			1.00		
Parking Bus, Adj	1.00	1.00	1.00	1.00	1.00	1.00		
Adj Sat Flow, veh/h/ln	1863	1863	1863	1863	1863	1863		
Adj Flow Rate, veh/h	364	229	109	3520	2447	194		
Adj No. of Lanes	1	1	1	2	2	1		
Peak Hour Factor	0.96	0.96	0.96	0.96	0.96	0.96		
Percent Heavy Veh, %	2	2	2	2	2	2		
Cap, veh/h	367	328	128	2557	2198	983		
Arrive On Green	0.21	0.21	0.07	0.72	0.62	0.62		
Sat Flow, veh/h	1774	1583	1774	3632	3632	1583		
Grp Volume(v), veh/h	364	229	109	3520	2447	194		
Grp Sat Flow(s),veh/h/ln	1774	1583	1774	1770	1770	1583		
Q Serve(g_s), s	39.6	25.9	11.7	139.6	120.0	10.2		
Cycle Q Clear(g_c), s	39.6	25.9	11.7	139.6	120.0	10.2		
Prop In Lane	1.00	1.00	1.00			1.00		
Lane Grp Cap(c), veh/h	367	328	128	2557	2198	983		
V/C Ratio(X)	0.99	0.70	0.85	1.38	1.11	0.20		
Avail Cap(c_a), veh/h	367	328	266	2557	2198	983		
HCM Platoon Ratio	1.00	1.00	1.00	1.00	1.00	1.00		
Upstream Filter(I)	1.00	1.00	1.00	1.00	1.00	1.00		
Uniform Delay (d), s/veh	76.4	71.0	88.6	26.8	36.6	15.8		
Incr Delay (d2), s/veh	44.5	6.4	14.5	171.9	58.0	0.1		
Initial Q Delay(d3),s/veh	0.0	0.0	0.0	0.0	0.0	0.0		
%ile BackOfQ(50%),veh/ln	23.9	22.6	6.3	128.6	76.0	4.5		
LnGrp Delay(d),s/veh	120.9	77.4	103.2	198.7	94.6	15.9		
LnGrp LOS	F	E	F	F	F	B		
Approach Vol, veh/h	593			3629	2641			
Approach Delay, s/veh	104.1			195.9	88.8			
Approach LOS	F			F	F			
Timer	1	2	3	4	5	6	7	8
Assigned Phs		2		4	5	6		
Phs Duration (G+Y+Rc), s		147.1		46.1	19.6	127.5		
Change Period (Y+Rc), s		7.5		6.1	* 5.7	7.5		
Max Green Setting (Gmax), s		85.0		40.0	* 29	120.0		
Max Q Clear Time (g_c+I1), s		141.6		41.6	13.7	122.0		
Green Ext Time (p_c), s		0.0		0.0	0.2	0.0		
Intersection Summary								
HCM 2010 Ctrl Delay			146.7					
HCM 2010 LOS			F					
Notes								



Movement	EBL	EBR	NBL	NBT	SBT	SBR		
Lane Configurations								
Traffic Volume (veh/h)	5	3	10	3724	2530	5		
Future Volume (veh/h)	5	3	10	3724	2530	5		
Number	7	14	5	2	6	16		
Initial Q (Qb), veh	0	0	0	0	0	0		
Ped-Bike Adj(A_pbT)	1.00	1.00	1.00			1.00		
Parking Bus, Adj	1.00	1.00	1.00	1.00	1.00	1.00		
Adj Sat Flow, veh/h/ln	1863	1900	1863	1863	1863	1863		
Adj Flow Rate, veh/h	5	3	11	3962	2691	5		
Adj No. of Lanes	0	0	1	2	2	1		
Peak Hour Factor	0.94	0.94	0.94	0.94	0.94	0.94		
Percent Heavy Veh, %	0	0	2	2	2	2		
Cap, veh/h	21	12	41	3029	2764	1237		
Arrive On Green	0.02	0.02	0.02	0.86	0.78	0.78		
Sat Flow, veh/h	952	571	1774	3632	3632	1583		
Grp Volume(v), veh/h	9	0	11	3962	2691	5		
Grp Sat Flow(s),veh/h/ln	1714	0	1774	1770	1770	1583		
Q Serve(g_s), s	0.6	0.0	0.7	95.0	77.1	0.1		
Cycle Q Clear(g_c), s	0.6	0.0	0.7	95.0	77.1	0.1		
Prop In Lane	0.56	0.33	1.00			1.00		
Lane Grp Cap(c), veh/h	37	0	41	3029	2764	1237		
V/C Ratio(X)	0.24	0.00	0.27	1.31	0.97	0.00		
Avail Cap(c_a), veh/h	525	0	383	3029	2773	1240		
HCM Platoon Ratio	1.00	1.00	1.00	1.00	1.00	1.00		
Upstream Filter(I)	1.00	0.00	1.00	1.00	1.00	1.00		
Uniform Delay (d), s/veh	53.4	0.0	53.3	8.0	11.1	2.7		
Incr Delay (d2), s/veh	3.3	0.0	3.4	141.2	11.6	0.0		
Initial Q Delay(d3),s/veh	0.0	0.0	0.0	0.0	0.0	0.0		
%ile BackOfQ(50%),veh/ln	0.3	0.0	0.4	103.6	41.1	0.0		
LnGrp Delay(d),s/veh	56.7	0.0	56.7	149.2	22.7	2.7		
LnGrp LOS	E		E	F	C	A		
Approach Vol, veh/h	9			3973	2696			
Approach Delay, s/veh	56.7			148.9	22.6			
Approach LOS	E			F	C			
Timer	1	2	3	4	5	6	7	8
Assigned Phs		2		4	5	6		
Phs Duration (G+Y+Rc), s		102.5		8.5	8.3	94.2		
Change Period (Y+Rc), s		7.5		6.1	* 5.7	7.5		
Max Green Setting (Gmax), s		85.0		34.0	* 24	87.0		
Max Q Clear Time (g_c+I1), s		97.0		2.6	2.7	79.1		
Green Ext Time (p_c), s		0.0		0.0	0.0	7.6		
Intersection Summary								
HCM 2010 Ctrl Delay			97.8					
HCM 2010 LOS			F					
Notes								

HCM 2010 Signalized Intersection Summary
 19: I-15 SB Ramps & Highway 76













Existing + Cumulative + Project PM
 07/10/2019



Movement	EBL	EBT	EBR	WBL	WBT	WBR	NBL	NBT	NBR	SBL	SBT	SBR
Lane Configurations		↑↑↑	↗		↑↑	↗				↖	↔	↗
Traffic Volume (veh/h)	0	1508	207	0	1450	205	0	0	0	596	0	704
Future Volume (veh/h)	0	1508	207	0	1450	205	0	0	0	596	0	704
Number	5	2	12	1	6	16				7	4	14
Initial Q (Qb), veh	0	0	0	0	0	0				0	0	0
Ped-Bike Adj(A_pbT)	1.00		1.00	1.00		1.00				1.00		1.00
Parking Bus, Adj	1.00	1.00	1.00	1.00	1.00	1.00				1.00	1.00	1.00
Adj Sat Flow, veh/h/ln	0	1863	1863	0	1863	1863				1863	1863	1863
Adj Flow Rate, veh/h	0	1539	211	0	1480	209				848	0	460
Adj No. of Lanes	0	3	1	0	2	1				2	0	1
Peak Hour Factor	0.98	0.98	0.98	0.98	0.98	0.98				0.98	0.98	0.98
Percent Heavy Veh, %	0	2	2	0	2	2				2	2	2
Cap, veh/h	0	2599	809	0	1809	1357				1228	0	548
Arrive On Green	0.00	0.51	0.51	0.00	0.51	0.51				0.35	0.00	0.35
Sat Flow, veh/h	0	5253	1583	0	3632	1583				3548	0	1583
Grp Volume(v), veh/h	0	1539	211	0	1480	209				848	0	460
Grp Sat Flow(s),veh/h/ln	0	1695	1583	0	1770	1583				1774	0	1583
Q Serve(g_s), s	0.0	20.2	7.2	0.0	33.4	2.1				19.5	0.0	25.5
Cycle Q Clear(g_c), s	0.0	20.2	7.2	0.0	33.4	2.1				19.5	0.0	25.5
Prop In Lane	0.00		1.00	0.00		1.00				1.00		1.00
Lane Grp Cap(c), veh/h	0	2599	809	0	1809	1357				1228	0	548
V/C Ratio(X)	0.00	0.59	0.26	0.00	0.82	0.15				0.69	0.00	0.84
Avail Cap(c_a), veh/h	0	2939	915	0	2157	1513				1864	0	832
HCM Platoon Ratio	1.00	1.00	1.00	1.00	1.00	1.00				1.00	1.00	1.00
Upstream Filter(I)	0.00	1.00	1.00	0.00	1.00	1.00				1.00	0.00	1.00
Uniform Delay (d), s/veh	0.0	16.3	13.1	0.0	19.6	1.1				26.7	0.0	28.7
Incr Delay (d2), s/veh	0.0	0.3	0.2	0.0	2.2	0.1				0.7	0.0	4.8
Initial Q Delay(d3),s/veh	0.0	0.0	0.0	0.0	0.0	0.0				0.0	0.0	0.0
%ile BackOfQ(50%),veh/ln	0.0	9.5	3.1	0.0	16.8	3.1				9.7	0.0	11.9
LnGrp Delay(d),s/veh	0.0	16.6	13.3	0.0	21.8	1.2				27.4	0.0	33.5
LnGrp LOS		B	B		C	A				C		C
Approach Vol, veh/h		1750			1689						1308	
Approach Delay, s/veh		16.2			19.2						29.6	
Approach LOS		B			B						C	
Timer	1	2	3	4	5	6	7	8				
Assigned Phs		2		4		6						
Phs Duration (G+Y+Rc), s		56.1		39.0		56.1						
Change Period (Y+Rc), s		7.5		6.1		7.5						
Max Green Setting (Gmax), s		55.0		50.0		58.0						
Max Q Clear Time (g_c+I1), s		22.2		27.5		35.4						
Green Ext Time (p_c), s		16.3		5.4		13.2						
Intersection Summary												
HCM 2010 Ctrl Delay				20.9								
HCM 2010 LOS				C								
Notes												

HCM 2010 Signalized Intersection Summary
20: I-15 NB Ramps & Highway 76

Existing + Cumulative Projects PM
04/30/2019













												
Movement	EBL	EBT	EBR	WBL	WBT	WBR	NBL	NBT	NBR	SBL	SBT	SBR
Lane Configurations		↑↑	↑		↑↑↑	↑	↑	↑	↑			
Traffic Volume (veh/h)	0	1449	628	0	1154	85	430	0	1966	0	0	0
Future Volume (veh/h)	0	1449	628	0	1154	85	430	0	1966	0	0	0
Number	5	2	12	1	6	16	3	8	18			
Initial Q (Qb), veh	0	0	0	0	0	0	0	0	0			
Ped-Bike Adj(A_pbT)	1.00		1.00	1.00		1.00	1.00		1.00			
Parking Bus, Adj	1.00	1.00	1.00	1.00	1.00	1.00	1.00	1.00	1.00			
Adj Sat Flow, veh/h/ln	0	1863	1863	0	1863	1863	1863	1863	1863			
Adj Flow Rate, veh/h	0	1479	641	0	1178	87	293	0	2163			
Adj No. of Lanes	0	2	1	0	3	1	1	0	2			
Peak Hour Factor	0.98	0.98	0.98	0.98	0.98	0.98	0.98	0.98	0.98			
Percent Heavy Veh, %	0	2	2	0	2	2	2	2	2			
Cap, veh/h	0	1639	1383	0	2355	733	728	0	1299			
Arrive On Green	0.00	0.46	0.46	0.00	0.46	0.46	0.41	0.00	0.41			
Sat Flow, veh/h	0	3632	1583	0	5253	1583	1774	0	3167			
Grp Volume(v), veh/h	0	1479	641	0	1178	87	293	0	2163			
Grp Sat Flow(s),veh/h/ln	0	1770	1583	0	1695	1583	1774	0	1583			
Q Serve(g_s), s	0.0	41.4	9.3	0.0	17.4	3.3	12.5	0.0	44.0			
Cycle Q Clear(g_c), s	0.0	41.4	9.3	0.0	17.4	3.3	12.5	0.0	44.0			
Prop In Lane	0.00		1.00	0.00		1.00	1.00		1.00			
Lane Grp Cap(c), veh/h	0	1639	1383	0	2355	733	728	0	1299			
V/C Ratio(X)	0.00	0.90	0.46	0.00	0.50	0.12	0.40	0.00	1.67			
Avail Cap(c_a), veh/h	0	1682	1402	0	2355	733	728	0	1299			
HCM Platoon Ratio	1.00	1.00	1.00	1.00	1.00	1.00	1.00	1.00	1.00			
Upstream Filter(I)	0.00	1.00	1.00	0.00	1.00	1.00	1.00	0.00	1.00			
Uniform Delay (d), s/veh	0.0	26.6	1.4	0.0	20.1	16.4	22.4	0.0	31.6			
Incr Delay (d2), s/veh	0.0	7.1	0.2	0.0	0.2	0.1	0.4	0.0	302.9			
Initial Q Delay(d3),s/veh	0.0	0.0	0.0	0.0	0.0	0.0	0.0	0.0	0.0			
%ile BackOfQ(50%),veh/ln	0.0	21.7	17.2	0.0	8.1	1.5	6.2	0.0	73.8			
LnGrp Delay(d),s/veh	0.0	33.6	1.7	0.0	20.3	16.4	22.7	0.0	334.5			
LnGrp LOS		C	A		C	B	C		F			
Approach Vol, veh/h		2120			1265			2456				
Approach Delay, s/veh		24.0			20.0			297.3				
Approach LOS		C			C			F				
Timer	1	2	3	4	5	6	7	8				
Assigned Phs		2				6		8				
Phs Duration (G+Y+Rc), s		57.2				57.2		50.1				
Change Period (Y+Rc), s		7.5				7.5		6.1				
Max Green Setting (Gmax), s		51.0				36.0		44.0				
Max Q Clear Time (g_c+I1), s		43.4				19.4		46.0				
Green Ext Time (p_c), s		6.3				8.1		0.0				
Intersection Summary												
HCM 2010 Ctrl Delay			138.1									
HCM 2010 LOS			F									
Notes												

Cumulative (No Project) Condition

HCM 2010 Signalized Intersection Summary 20: I-15 NB Ramps & Highway 76

Existing + Cumulative Projects PM

04/30/2019

												
Movement	EBL	EBT	EBR	WBL	WBT	WBR	NBL	NBT	NBR	SBL	SBT	SBR
Lane Configurations		↑↑	↗		↑↑↑	↗	↗	↔	↗			
Traffic Volume (veh/h)	0	1449	628	0	1154	85	430	0	1966	0	0	0
Future Volume (veh/h)	0	1449	628	0	1154	85	430	0	1966	0	0	0
Number	5	2	12	1	6	16	3	8	18			
Initial Q (Qb), veh	0	0	0	0	0	0	0	0	0			
Ped-Bike Adj(A_pbT)	1.00		1.00	1.00		1.00	1.00		1.00			
Parking Bus, Adj	1.00	1.00	1.00	1.00	1.00	1.00	1.00	1.00	1.00			
Adj Sat Flow, veh/h/ln	0	1863	1863	0	1863	1863	1863	1863	1863			
Adj Flow Rate, veh/h	0	1479	641	0	1178	87	293	0	2163			
Adj No. of Lanes	0	2	1	0	3	1	1	0	2			
Peak Hour Factor	0.98	0.98	0.98	0.98	0.98	0.98	0.98	0.98	0.98			
Percent Heavy Veh, %	0	2	2	0	2	2	2	2	2			
Cap, veh/h	0	1639	1383	0	2355	733	728	0	1299			
Arrive On Green	0.00	0.46	0.46	0.00	0.46	0.46	0.41	0.00	0.41			
Sat Flow, veh/h	0	3632	1583	0	5253	1583	1774	0	3167			
Grp Volume(v), veh/h	0	1479	641	0	1178	87	293	0	2163			
Grp Sat Flow(s),veh/h/ln	0	1770	1583	0	1695	1583	1774	0	1583			
Q Serve(g_s), s	0.0	41.4	9.3	0.0	17.4	3.3	12.5	0.0	44.0			
Cycle Q Clear(g_c), s	0.0	41.4	9.3	0.0	17.4	3.3	12.5	0.0	44.0			
Prop In Lane	0.00		1.00	0.00		1.00	1.00		1.00			
Lane Grp Cap(c), veh/h	0	1639	1383	0	2355	733	728	0	1299			
V/C Ratio(X)	0.00	0.90	0.46	0.00	0.50	0.12	0.40	0.00	1.67			
Avail Cap(c_a), veh/h	0	1682	1402	0	2355	733	728	0	1299			
HCM Platoon Ratio	1.00	1.00	1.00	1.00	1.00	1.00	1.00	1.00	1.00			
Upstream Filter(I)	0.00	1.00	1.00	0.00	1.00	1.00	1.00	0.00	1.00			
Uniform Delay (d), s/veh	0.0	26.6	1.4	0.0	20.1	16.4	22.4	0.0	31.6			
Incr Delay (d2), s/veh	0.0	7.1	0.2	0.0	0.2	0.1	0.4	0.0	302.9			
Initial Q Delay(d3),s/veh	0.0	0.0	0.0	0.0	0.0	0.0	0.0	0.0	0.0			
%ile BackOfQ(50%),veh/ln	0.0	21.7	17.2	0.0	8.1	1.5	6.2	0.0	73.8			
LnGrp Delay(d),s/veh	0.0	33.6	1.7	0.0	20.3	16.4	22.7	0.0	334.5			
LnGrp LOS		C	A		C	B	C		F			
Approach Vol, veh/h		2120			1265			2456				
Approach Delay, s/veh		24.0			20.0			297.3				
Approach LOS		C			C			F				
Timer	1	2	3	4	5	6	7	8				
Assigned Phs		2				6		8				
Phs Duration (G+Y+Rc), s		57.2				57.2		50.1				
Change Period (Y+Rc), s		7.5				7.5		6.1				
Max Green Setting (Gmax), s		51.0				36.0		44.0				
Max Q Clear Time (g_c+I1), s		43.4				19.4		46.0				
Green Ext Time (p_c), s		6.3				8.1		0.0				
Intersection Summary												
HCM 2010 Ctrl Delay			138.1									
HCM 2010 LOS			F									
Notes												

Note: Synchro calculates the average delay by taking into account the delay of all movements and the number of vehicles at an intersection. If adding project traffic to a movement would not increase delay significantly, the overall average delay may go down, as is the case here in the p.m. peak hour.

Cumulative (Plus Project)

HCM 2010 Signalized Intersection Summary 20: I-15 NB Ramps & Highway 76

Existing + Cumulative + Project PM

07/10/2019



Movement	EBL	EBT	EBR	WBL	WBT	WBR	NBL	NBT	NBR	SBL	SBT	SBR
Lane Configurations		↑↑	↑		↑↑↑	↑	↑	↑	↑			
Traffic Volume (veh/h)	0	1463	633	0	1188	85	430	0	1966	0	0	0
Future Volume (veh/h)	0	1463	633	0	1188	85	430	0	1966	0	0	0
Number	5	2	12	1	6	16	3	8	18			
Initial Q (Qb), veh	0	0	0	0	0	0	0	0	0			
Ped-Bike Adj(A_pbT)	1.00		1.00	1.00		1.00	1.00		1.00			
Parking Bus, Adj	1.00	1.00	1.00	1.00	1.00	1.00	1.00	1.00	1.00			
Adj Sat Flow, veh/h/ln	0	1863	1863	0	1863	1863	1863	1863	1863			
Adj Flow Rate, veh/h	0	1493	646	0	1212	87	293	0	2163			
Adj No. of Lanes	0	2	1	0	3	1	1	0	2			
Peak Hour Factor	0.98	0.98	0.98	0.98	0.98	0.98	0.98	0.98	0.98			
Percent Heavy Veh, %	0	2	2	0	2	2	2	2	2			
Cap, veh/h	0	1643	1383	0	2360	735	726	0	1296			
Arrive On Green	0.00	0.46	0.46	0.00	0.46	0.46	0.41	0.00	0.41			
Sat Flow, veh/h	0	3632	1583	0	5253	1583	1774	0	3167			
Grp Volume(v), veh/h	0	1493	646	0	1212	87	293	0	2163			
Grp Sat Flow(s),veh/h/ln	0	1770	1583	0	1695	1583	1774	0	1583			
Q Serve(g_s), s	0.0	42.0	9.4	0.0	18.0	3.3	12.6	0.0	44.0			
Cycle Q Clear(g_c), s	0.0	42.0	9.4	0.0	18.0	3.3	12.6	0.0	44.0			
Prop In Lane	0.00		1.00	0.00		1.00	1.00		1.00			
Lane Grp Cap(c), veh/h	0	1643	1383	0	2360	735	726	0	1296			
V/C Ratio(X)	0.00	0.91	0.47	0.00	0.51	0.12	0.40	0.00	1.67			
Avail Cap(c_a), veh/h	0	1679	1399	0	2360	735	726	0	1296			
HCM Platoon Ratio	1.00	1.00	1.00	1.00	1.00	1.00	1.00	1.00	1.00			
Upstream Filter(I)	0.00	1.00	1.00	0.00	1.00	1.00	1.00	0.00	1.00			
Uniform Delay (d), s/veh	0.0	26.7	1.5	0.0	20.3	16.3	22.5	0.0	31.7			
Incr Delay (d2), s/veh	0.0	7.6	0.2	0.0	0.2	0.1	0.4	0.0	304.3			
Initial Q Delay(d3),s/veh	0.0	0.0	0.0	0.0	0.0	0.0	0.0	0.0	0.0			
%ile BackOfQ(50%),veh/ln	0.0	22.1	17.3	0.0	8.5	1.5	6.2	0.0	73.9			
LnGrp Delay(d),s/veh	0.0	34.3	1.7	0.0	20.5	16.4	22.8	0.0	336.0			
LnGrp LOS		C	A		C	B	C		F			
Approach Vol, veh/h		2139			1299			2456				
Approach Delay, s/veh		24.5			20.2			298.7				
Approach LOS		C			C			F				
Timer	1	2	3	4	5	6	7	8				
Assigned Phs		2				6		8				
Phs Duration (G+Y+Rc), s		57.4				57.4		50.1				
Change Period (Y+Rc), s		7.5				7.5		6.1				
Max Green Setting (Gmax), s		51.0				36.0		44.0				
Max Q Clear Time (g_c+I1), s		44.0				20.0		46.0				
Green Ext Time (p_c), s		5.9				8.1		0.0				
Intersection Summary												
HCM 2010 Ctrl Delay			137.8									
HCM 2010 LOS			F									
Notes												

Queues
1: Highway 76 & Olive Hill Road/Camino Del Rey

Existing AM Peak Hour
07/10/2019



Lane Group	EBL	EBT	EBR	WBL	WBT	WBR	NBL	NBT	NBR	SBL	SBT	SBR
Lane Group Flow (vph)	104	197	161	117	74	228	96	1076	174	590	2190	50
v/c Ratio	0.22	0.78	0.49	0.53	0.32	0.58	0.54	0.52	0.23	0.87	0.86	0.06
Control Delay	74.7	100.6	24.3	85.1	77.7	13.3	95.3	46.7	6.8	87.8	46.2	4.0
Queue Delay	0.0	0.0	0.0	0.0	0.0	0.0	0.0	0.0	0.0	0.0	0.0	0.0
Total Delay	74.7	100.6	24.3	85.1	77.7	13.3	95.3	46.7	6.8	87.8	46.2	4.0
Queue Length 50th (ft)	55	220	33	131	81	0	107	334	0	340	767	0
Queue Length 95th (ft)	111	406	135	226	151	85	221	605	68	527	#1383	20
Internal Link Dist (ft)		411			1394			566			793	
Turn Bay Length (ft)	217		217	158		223	840		480	600		480
Base Capacity (vph)	640	347	400	514	541	621	291	2509	869	978	3123	997
Starvation Cap Reductn	0	0	0	0	0	0	0	0	0	0	0	0
Spillback Cap Reductn	0	0	0	0	0	0	0	0	0	0	0	0
Storage Cap Reductn	0	0	0	0	0	0	0	0	0	0	0	0
Reduced v/c Ratio	0.16	0.57	0.40	0.23	0.14	0.37	0.33	0.43	0.20	0.60	0.70	0.05

Intersection Summary

95th percentile volume exceeds capacity, queue may be longer.
Queue shown is maximum after two cycles.

Queues
4: Old Highway 395 & Highway 76

Existing AM Peak Hour
07/10/2019



Lane Group	EBL	EBT	EBR	WBL	WBT	WBR	NBL	NBT	NBR	SBL	SBT
Lane Group Flow (vph)	82	717	160	255	1144	82	166	71	47	131	480
v/c Ratio	0.51	0.51	0.29	0.86	0.92	0.07	0.78	0.45	0.10	0.12	0.92
Control Delay	95.3	59.7	8.4	102.7	70.2	1.5	104.4	94.6	3.3	42.8	85.1
Queue Delay	0.0	0.0	0.0	0.0	1.0	0.0	0.0	0.0	0.0	0.0	0.0
Total Delay	95.3	59.7	8.4	102.7	71.2	1.5	104.4	94.6	3.3	42.8	85.1
Queue Length 50th (ft)	99	280	0	313	724	3	202	86	0	56	556
Queue Length 95th (ft)	175	357	65	#548	#1002	12	312	156	13	88	#797
Internal Link Dist (ft)		258			777			2696			2843
Turn Bay Length (ft)	325		500	410			320		195	340	
Base Capacity (vph)	258	1680	630	297	1246	1168	287	332	460	1254	621
Starvation Cap Reductn	0	0	0	0	22	0	0	0	0	0	0
Spillback Cap Reductn	0	0	0	0	0	0	0	0	0	0	0
Storage Cap Reductn	0	0	0	0	0	0	0	0	0	0	0
Reduced v/c Ratio	0.32	0.43	0.25	0.86	0.93	0.07	0.58	0.21	0.10	0.10	0.77

Intersection Summary

95th percentile volume exceeds capacity, queue may be longer.
Queue shown is maximum after two cycles.

Queues
16: SR-76 & Old River Rd/East Vista Way

Existing AM Peak Hour
07/10/2019



Lane Group	EBT	WBL	WBT	WBR	NBL	NBT	NBR	SBL	SBT
Lane Group Flow (vph)	311	143	147	352	71	795	356	554	1575
v/c Ratio	0.65	0.59	0.60	0.41	0.43	0.52	0.49	0.69	0.71
Control Delay	47.4	68.1	68.4	5.9	72.4	41.6	6.3	53.7	33.0
Queue Delay	0.0	0.0	0.0	0.0	0.0	0.0	0.0	0.0	0.0
Total Delay	47.4	68.1	68.4	5.9	72.4	41.6	6.3	53.7	33.0
Queue Length 50th (ft)	92	121	124	19	58	207	0	222	390
Queue Length 95th (ft)	182	248	253	98	138	317	78	372	567
Internal Link Dist (ft)	283		112			1144			2405
Turn Bay Length (ft)					835		540	385	
Base Capacity (vph)	834	495	500	973	411	3467	1192	1117	3915
Starvation Cap Reductn	0	0	0	0	0	0	0	0	0
Spillback Cap Reductn	0	0	0	0	0	0	0	0	0
Storage Cap Reductn	0	0	0	0	0	0	0	0	0
Reduced v/c Ratio	0.37	0.29	0.29	0.36	0.17	0.23	0.30	0.50	0.40
Intersection Summary									

Queues
17: SR-76 & N River Rd

Existing AM Peak Hour
07/10/2019



Lane Group	EBL	EBR	NBL	NBT	SBT	SBR
Lane Group Flow (vph)	188	151	145	1124	1965	571
v/c Ratio	0.77	0.55	0.73	0.40	0.86	0.47
Control Delay	98.2	49.9	100.6	6.9	32.6	2.5
Queue Delay	0.0	0.0	0.0	0.0	0.0	0.0
Total Delay	98.2	49.9	100.6	6.9	32.6	2.5
Queue Length 50th (ft)	224	99	174	195	946	0
Queue Length 95th (ft)	336	188	271	290	1369	52
Internal Link Dist (ft)	360			1017	712	
Turn Bay Length (ft)		70	770			685
Base Capacity (vph)	395	403	286	3025	2370	1249
Starvation Cap Reductn	0	0	0	0	0	0
Spillback Cap Reductn	0	0	0	0	0	0
Storage Cap Reductn	0	0	0	0	0	0
Reduced v/c Ratio	0.48	0.37	0.51	0.37	0.83	0.46

Intersection Summary

Queues
18: SR-76 & Via Montellano

Existing AM Peak Hour
07/10/2019



Lane Group	EBL	NBL	NBT	SBT	SBR
Lane Group Flow (vph)	15	3	1322	2422	9
v/c Ratio	0.07	0.02	0.42	0.78	0.01
Control Delay	34.2	59.7	4.4	12.5	5.8
Queue Delay	0.0	0.0	0.0	0.0	0.0
Total Delay	34.2	59.7	4.4	12.5	5.8
Queue Length 50th (ft)	5	2	0	0	0
Queue Length 95th (ft)	26	14	375	#1601	10
Internal Link Dist (ft)	324		613	589	
Turn Bay Length (ft)		565			445
Base Capacity (vph)	495	360	3365	3104	1389
Starvation Cap Reductn	0	0	0	0	0
Spillback Cap Reductn	0	0	0	0	0
Storage Cap Reductn	0	0	0	0	0
Reduced v/c Ratio	0.03	0.01	0.39	0.78	0.01

Intersection Summary

95th percentile volume exceeds capacity, queue may be longer.
Queue shown is maximum after two cycles.

Queues
19: I-15 SB Ramps & Highway 76

Existing AM Peak Hour
07/10/2019



Lane Group	EBT	EBR	WBT	WBR	SBL	SBT	SBR
Lane Group Flow (vph)	781	167	446	131	48	744	738
v/c Ratio	0.62	0.32	0.62	0.13	0.09	0.83	0.81
Control Delay	40.1	7.8	44.8	1.8	27.5	15.8	14.1
Queue Delay	0.0	0.0	0.0	0.0	0.0	0.0	0.0
Total Delay	40.1	7.8	44.8	1.8	27.5	15.8	14.1
Queue Length 50th (ft)	177	0	152	0	23	67	60
Queue Length 95th (ft)	290	59	247	23	66	367	317
Internal Link Dist (ft)	777		1242			680	
Turn Bay Length (ft)		600			400		
Base Capacity (vph)	2847	959	2090	1258	855	1038	1069
Starvation Cap Reductn	0	0	0	0	0	0	0
Spillback Cap Reductn	0	0	0	0	0	0	0
Storage Cap Reductn	0	0	0	0	0	0	0
Reduced v/c Ratio	0.27	0.17	0.21	0.10	0.06	0.72	0.69
Intersection Summary							

Queues
20: I-15 NB Ramps & Highway 76

Existing AM Peak Hour
07/10/2019



Lane Group	EBT	EBR	WBT	WBR	NBL	NBT	NBR
Lane Group Flow (vph)	203	645	361	64	96	95	87
v/c Ratio	0.25	0.54	0.41	0.19	0.24	0.22	0.20
Control Delay	23.7	2.3	29.1	8.8	23.3	8.2	7.1
Queue Delay	0.0	0.0	0.0	0.0	0.0	0.0	0.0
Total Delay	23.7	2.3	29.1	8.8	23.3	8.2	7.1
Queue Length 50th (ft)	28	0	38	0	26	2	0
Queue Length 95th (ft)	95	30	131	32	102	47	37
Internal Link Dist (ft)	1242		359			627	
Turn Bay Length (ft)				545	325		
Base Capacity (vph)	2986	1411	3088	991	1247	1191	1138
Starvation Cap Reductn	0	0	0	0	0	0	0
Spillback Cap Reductn	0	0	0	0	0	0	0
Storage Cap Reductn	0	0	0	0	0	0	0
Reduced v/c Ratio	0.07	0.46	0.12	0.06	0.08	0.08	0.08
Intersection Summary							

Queues
1: Highway 76 & Olive Hill Road/Camino Del Rey

Existing PM Peak Hour
07/10/2019



Lane Group	EBL	EBT	EBR	WBL	WBT	WBR	NBL	NBT	NBR	SBL	SBT	SBR
Lane Group Flow (vph)	114	61	126	138	120	303	142	2309	142	221	1349	50
v/c Ratio	0.39	0.39	0.51	0.55	0.46	0.68	0.68	0.86	0.16	0.67	0.52	0.06
Control Delay	81.7	86.2	19.3	76.6	72.6	20.7	91.3	40.1	10.0	87.1	31.7	2.4
Queue Delay	0.0	0.0	0.0	0.0	0.0	0.0	0.0	0.0	0.0	0.0	0.0	0.0
Total Delay	81.7	86.2	19.3	76.6	72.6	20.7	91.3	40.1	10.0	87.1	31.7	2.4
Queue Length 50th (ft)	60	63	0	145	124	47	150	738	24	120	332	0
Queue Length 95th (ft)	117	141	77	229	202	155	273	#1326	91	203	603	12
Internal Link Dist (ft)		415			1392			517			829	
Turn Bay Length (ft)	217		217	158		223	840		480	600		480
Base Capacity (vph)	484	262	331	551	580	669	311	2779	907	544	2689	871
Starvation Cap Reductn	0	0	0	0	0	0	0	0	0	0	0	0
Spillback Cap Reductn	0	0	0	0	0	0	0	0	0	0	0	0
Storage Cap Reductn	0	0	0	0	0	0	0	0	0	0	0	0
Reduced v/c Ratio	0.24	0.23	0.38	0.25	0.21	0.45	0.46	0.83	0.16	0.41	0.50	0.06

Intersection Summary

95th percentile volume exceeds capacity, queue may be longer.
Queue shown is maximum after two cycles.

Queues
4: Old Highway 395 & Highway 76

Existing PM Peak Hour
07/10/2019



Lane Group	EBL	EBT	EBR	WBL	WBT	WBR	NBL	NBT	NBR	SBL	SBT
Lane Group Flow (vph)	165	1146	120	40	923	244	120	170	53	203	142
v/c Ratio	0.61	0.57	0.17	0.18	0.80	0.27	0.54	0.60	0.10	0.38	0.42
Control Delay	69.5	35.6	6.3	67.7	49.1	2.0	71.1	67.7	5.1	53.8	46.4
Queue Delay	0.0	0.0	0.0	0.0	0.0	0.0	0.0	0.0	0.0	0.0	0.0
Total Delay	69.5	35.6	6.3	67.7	49.1	2.0	71.1	67.7	5.1	53.8	46.4
Queue Length 50th (ft)	121	261	0	28	330	2	89	125	0	77	88
Queue Length 95th (ft)	319	527	51	101	718	24	239	316	18	151	195
Internal Link Dist (ft)		258			777			2696			2843
Turn Bay Length (ft)	325		500	410			320		195	340	
Base Capacity (vph)	380	2540	851	436	1829	1188	422	488	690	1666	892
Starvation Cap Reductn	0	0	0	0	7	0	0	0	0	0	0
Spillback Cap Reductn	0	0	0	0	0	0	0	0	0	0	0
Storage Cap Reductn	0	0	0	0	0	0	0	0	0	0	0
Reduced v/c Ratio	0.43	0.45	0.14	0.09	0.51	0.21	0.28	0.35	0.08	0.12	0.16

Intersection Summary

Queues
16: SR-76 & Old River Rd/East Vista Way

Existing PM Peak Hour
07/10/2019



Lane Group	EBT	WBL	WBT	WBR	NBL	NBT	NBR	SBL	SBT
Lane Group Flow (vph)	189	124	125	665	67	1732	285	524	1039
v/c Ratio	0.58	0.68	0.67	0.90	0.51	0.75	0.33	0.69	0.34
Control Delay	33.8	95.7	94.5	49.5	95.8	42.3	4.9	68.5	18.0
Queue Delay	0.0	0.0	0.0	0.0	0.0	0.0	0.0	0.0	0.0
Total Delay	33.8	95.7	94.5	49.5	95.8	42.3	4.9	68.5	18.0
Queue Length 50th (ft)	32	153	154	533	79	606	10	295	202
Queue Length 95th (ft)	81	245	246	#823	145	736	73	397	287
Internal Link Dist (ft)	283		112			1144			2405
Turn Bay Length (ft)					835		540	385	
Base Capacity (vph)	667	376	384	771	312	2636	950	849	3231
Starvation Cap Reductn	0	0	0	0	0	0	0	0	0
Spillback Cap Reductn	0	0	0	0	0	0	0	0	0
Storage Cap Reductn	0	0	0	0	0	0	0	0	0
Reduced v/c Ratio	0.28	0.33	0.33	0.86	0.21	0.66	0.30	0.62	0.32

Intersection Summary

95th percentile volume exceeds capacity, queue may be longer.
Queue shown is maximum after two cycles.



Lane Group	EBL	EBR	NBL	NBT	SBT	SBR
Lane Group Flow (vph)	357	229	109	2284	1381	192
v/c Ratio	0.75	0.50	0.63	1.01	0.77	0.21
Control Delay	63.4	42.1	82.8	47.1	33.9	2.9
Queue Delay	0.0	0.0	0.0	0.0	0.0	0.0
Total Delay	63.4	42.1	82.8	47.1	33.9	2.9
Queue Length 50th (ft)	304	138	100	~1201	562	0
Queue Length 95th (ft)	#594	285	191	1257	709	41
Internal Link Dist (ft)	360			1017	712	
Turn Bay Length (ft)		70	770			685
Base Capacity (vph)	473	461	343	3445	2841	1308
Starvation Cap Reductn	0	0	0	0	0	0
Spillback Cap Reductn	0	0	0	0	0	0
Storage Cap Reductn	0	0	0	0	0	0
Reduced v/c Ratio	0.75	0.50	0.32	0.66	0.49	0.15

Intersection Summary

- ~ Volume exceeds capacity, queue is theoretically infinite.
Queue shown is maximum after two cycles.
- # 95th percentile volume exceeds capacity, queue may be longer.
Queue shown is maximum after two cycles.

Queues
18: SR-76 & Via Montellano

Existing PM Peak Hour
07/10/2019



Lane Group	EBL	NBL	NBT	SBT	SBR
Lane Group Flow (vph)	8	11	2694	1601	5
v/c Ratio	0.04	0.08	0.85	0.52	0.00
Control Delay	38.8	59.3	12.6	7.9	5.6
Queue Delay	0.0	0.0	0.0	0.0	0.0
Total Delay	38.8	59.3	12.6	7.9	5.6
Queue Length 50th (ft)	3	7	0	0	0
Queue Length 95th (ft)	19	32	#1696	698	6
Internal Link Dist (ft)	324		613	589	
Turn Bay Length (ft)		565			445
Base Capacity (vph)	502	365	3365	3104	1389
Starvation Cap Reductn	0	0	0	0	0
Spillback Cap Reductn	0	0	0	0	0
Storage Cap Reductn	0	0	0	0	0
Reduced v/c Ratio	0.02	0.03	0.80	0.52	0.00

Intersection Summary

95th percentile volume exceeds capacity, queue may be longer.
Queue shown is maximum after two cycles.

Queues
19: I-15 SB Ramps & Highway 76

Existing PM Peak Hour
07/10/2019



Lane Group	EBT	EBR	WBT	WBR	SBL	SBT	SBR
Lane Group Flow (vph)	1072	211	658	128	52	360	353
v/c Ratio	0.60	0.30	0.66	0.15	0.22	0.71	0.69
Control Delay	28.5	4.9	36.3	3.0	43.9	13.9	12.4
Queue Delay	0.0	0.0	0.0	0.0	0.0	0.0	0.0
Total Delay	28.5	4.9	36.3	3.0	43.9	13.9	12.4
Queue Length 50th (ft)	186	0	177	0	29	3	0
Queue Length 95th (ft)	331	54	342	31	83	110	95
Internal Link Dist (ft)	777		1242			680	
Turn Bay Length (ft)		600			400		
Base Capacity (vph)	3016	1025	2214	1412	906	941	973
Starvation Cap Reductn	0	0	0	0	0	0	0
Spillback Cap Reductn	0	0	0	0	0	0	0
Storage Cap Reductn	0	0	0	0	0	0	0
Reduced v/c Ratio	0.36	0.21	0.30	0.09	0.06	0.38	0.36
Intersection Summary							

Queues
20: I-15 NB Ramps & Highway 76

Existing PM Peak Hour
07/10/2019



Lane Group	EBT	EBR	WBT	WBR	NBL	NBT	NBR
Lane Group Flow (vph)	482	641	309	53	395	412	414
v/c Ratio	0.61	0.49	0.46	0.19	0.57	0.54	0.48
Control Delay	37.0	1.7	42.0	6.1	27.7	10.8	4.6
Queue Delay	0.0	0.0	0.0	0.0	0.0	0.0	0.0
Total Delay	37.0	1.7	42.0	6.1	27.7	10.8	4.6
Queue Length 50th (ft)	143	0	65	0	172	50	0
Queue Length 95th (ft)	217	31	114	20	414	213	75
Internal Link Dist (ft)	1242		359			627	
Turn Bay Length (ft)				545	325		
Base Capacity (vph)	1994	1315	2022	675	816	853	943
Starvation Cap Reductn	0	0	0	0	0	0	0
Spillback Cap Reductn	0	0	0	0	0	0	0
Storage Cap Reductn	0	0	0	0	0	0	0
Reduced v/c Ratio	0.24	0.49	0.15	0.08	0.48	0.48	0.44
Intersection Summary							

Queues
1: Highway 76 & Olive Hill Road/Camino Del Rey

Existing + Project AM Peak Hour

07/10/2019



Lane Group	EBL	EBT	EBR	WBL	WBT	WBR	NBL	NBT	NBR	SBL	SBT	SBR
Lane Group Flow (vph)	104	197	161	168	74	238	96	1076	196	595	2190	50
v/c Ratio	0.22	0.78	0.50	0.67	0.28	0.55	0.55	0.55	0.27	0.87	0.88	0.06
Control Delay	76.7	102.9	24.9	90.7	75.7	12.2	98.3	50.1	6.7	89.1	50.0	3.8
Queue Delay	0.0	0.0	0.0	0.0	0.0	0.0	0.0	0.0	0.0	0.0	0.0	0.0
Total Delay	76.7	102.9	24.9	90.7	75.7	12.2	98.3	50.1	6.7	89.1	50.0	3.8
Queue Length 50th (ft)	57	230	34	196	81	0	112	367	0	359	842	0
Queue Length 95th (ft)	111	406	136	317	152	86	222	604	70	535	#1382	20
Internal Link Dist (ft)		417			1388			820			807	
Turn Bay Length (ft)	217		217	158		223	840		480	600		480
Base Capacity (vph)	623	338	393	501	527	618	283	2445	863	953	3043	973
Starvation Cap Reductn	0	0	0	0	0	0	0	0	0	0	0	0
Spillback Cap Reductn	0	0	0	0	0	0	0	0	0	0	0	0
Storage Cap Reductn	0	0	0	0	0	0	0	0	0	0	0	0
Reduced v/c Ratio	0.17	0.58	0.41	0.34	0.14	0.39	0.34	0.44	0.23	0.62	0.72	0.05

Intersection Summary

95th percentile volume exceeds capacity, queue may be longer.
Queue shown is maximum after two cycles.

Queues
4: Old Highway 395 & Highway 76

Existing + Project AM Peak Hour

07/10/2019



Lane Group	EBL	EBT	EBR	WBL	WBT	WBR	NBL	NBT	NBR	SBL	SBT
Lane Group Flow (vph)	82	717	164	272	1144	82	173	78	84	131	483
v/c Ratio	0.51	0.51	0.30	0.92	0.92	0.07	0.79	0.49	0.18	0.12	0.92
Control Delay	96.0	60.4	8.4	111.6	71.7	1.6	105.7	96.0	5.8	42.9	85.5
Queue Delay	0.0	0.0	0.0	0.0	1.1	0.0	0.0	0.0	0.0	0.0	0.0
Total Delay	96.0	60.4	8.4	111.6	72.8	1.6	105.7	96.0	5.8	42.9	85.5
Queue Length 50th (ft)	100	285	0	342	737	3	213	96	0	56	565
Queue Length 95th (ft)	175	357	66	#599	#1002	13	324	168	28	89	#805
Internal Link Dist (ft)		258			777			2696			2843
Turn Bay Length (ft)	325		500	410			320		195	340	
Base Capacity (vph)	257	1668	629	295	1237	1162	285	330	476	1249	617
Starvation Cap Reductn	0	0	0	0	22	0	0	0	0	0	0
Spillback Cap Reductn	0	0	0	0	0	0	0	0	0	0	0
Storage Cap Reductn	0	0	0	0	0	0	0	0	0	0	0
Reduced v/c Ratio	0.32	0.43	0.26	0.92	0.94	0.07	0.61	0.24	0.18	0.10	0.78

Intersection Summary

95th percentile volume exceeds capacity, queue may be longer.
Queue shown is maximum after two cycles.

Queues
16: SR-76 & Old River Rd/East Vista Way

Existing + Project AM Peak Hour

07/10/2019



Lane Group	EBT	WBL	WBT	WBR	NBL	NBT	NBR	SBL	SBT
Lane Group Flow (vph)	311	143	147	357	71	809	356	566	1608
v/c Ratio	0.65	0.59	0.60	0.42	0.43	0.53	0.49	0.70	0.71
Control Delay	48.4	69.5	69.8	6.3	73.9	41.9	6.2	54.4	33.0
Queue Delay	0.0	0.0	0.0	0.0	0.0	0.0	0.0	0.0	0.0
Total Delay	48.4	69.5	69.8	6.3	73.9	41.9	6.2	54.4	33.0
Queue Length 50th (ft)	93	123	126	22	59	215	0	228	404
Queue Length 95th (ft)	184	251	256	108	139	322	78	388	583
Internal Link Dist (ft)	283		112			1144			2405
Turn Bay Length (ft)					835		540	385	
Base Capacity (vph)	823	487	493	964	405	3419	1180	1101	3863
Starvation Cap Reductn	0	0	0	0	0	0	0	0	0
Spillback Cap Reductn	0	0	0	0	0	0	0	0	0
Storage Cap Reductn	0	0	0	0	0	0	0	0	0
Reduced v/c Ratio	0.38	0.29	0.30	0.37	0.18	0.24	0.30	0.51	0.42

Intersection Summary

Queues
17: SR-76 & N River Rd

Existing + Project AM Peak Hour
07/10/2019



Lane Group	EBL	EBR	NBL	NBT	SBT	SBR
Lane Group Flow (vph)	191	151	145	1143	2009	575
v/c Ratio	0.79	0.56	0.74	0.41	0.88	0.47
Control Delay	100.3	50.6	102.6	7.0	33.7	2.5
Queue Delay	0.0	0.0	0.0	0.0	0.0	0.0
Total Delay	100.3	50.6	102.6	7.0	33.7	2.5
Queue Length 50th (ft)	229	100	174	202	1000	0
Queue Length 95th (ft)	341	190	272	300	#1452	53
Internal Link Dist (ft)	360			1017	712	
Turn Bay Length (ft)		70	770			685
Base Capacity (vph)	386	395	280	2991	2320	1236
Starvation Cap Reductn	0	0	0	0	0	0
Spillback Cap Reductn	0	0	0	0	0	0
Storage Cap Reductn	0	0	0	0	0	0
Reduced v/c Ratio	0.49	0.38	0.52	0.38	0.87	0.47

Intersection Summary

95th percentile volume exceeds capacity, queue may be longer.
Queue shown is maximum after two cycles.

Queues
18: SR-76 & Via Montellano

Existing + Project AM Peak Hour
07/10/2019



Lane Group	EBL	NBL	NBT	SBT	SBR
Lane Group Flow (vph)	15	3	1343	2470	9
v/c Ratio	0.07	0.02	0.42	0.80	0.01
Control Delay	34.2	59.7	4.5	12.8	5.8
Queue Delay	0.0	0.0	0.0	0.0	0.0
Total Delay	34.2	59.7	4.5	12.8	5.8
Queue Length 50th (ft)	5	2	0	0	0
Queue Length 95th (ft)	26	14	385	#1650	10
Internal Link Dist (ft)	324		613	589	
Turn Bay Length (ft)		565			445
Base Capacity (vph)	495	360	3365	3104	1389
Starvation Cap Reductn	0	0	0	0	0
Spillback Cap Reductn	0	0	0	0	0
Storage Cap Reductn	0	0	0	0	0
Reduced v/c Ratio	0.03	0.01	0.40	0.80	0.01

Intersection Summary

95th percentile volume exceeds capacity, queue may be longer.
Queue shown is maximum after two cycles.

Queues
19: I-15 SB Ramps & Highway 76

Existing + Project AM Peak Hour

07/10/2019



Lane Group	EBT	EBR	WBT	WBR	SBL	SBT	SBR
Lane Group Flow (vph)	821	167	459	131	48	746	740
v/c Ratio	0.64	0.32	0.63	0.13	0.09	0.84	0.81
Control Delay	40.8	7.7	45.9	1.8	28.2	16.6	14.8
Queue Delay	0.0	0.0	0.0	0.0	0.0	0.0	0.0
Total Delay	40.8	7.7	45.9	1.8	28.2	16.6	14.8
Queue Length 50th (ft)	194	0	163	0	23	79	66
Queue Length 95th (ft)	305	59	258	24	67	385	335
Internal Link Dist (ft)	777		1242			680	
Turn Bay Length (ft)		600			400		
Base Capacity (vph)	2775	940	2037	1243	834	1024	1055
Starvation Cap Reductn	0	0	0	0	0	0	0
Spillback Cap Reductn	0	0	0	0	0	0	0
Storage Cap Reductn	0	0	0	0	0	0	0
Reduced v/c Ratio	0.30	0.18	0.23	0.11	0.06	0.73	0.70
Intersection Summary							

Queues
20: I-15 NB Ramps & Highway 76

Existing + Project AM Peak Hour

07/10/2019



Lane Group	EBT	EBR	WBT	WBR	NBL	NBT	NBR
Lane Group Flow (vph)	231	654	374	64	96	95	87
v/c Ratio	0.28	0.54	0.42	0.19	0.24	0.22	0.20
Control Delay	24.0	2.3	29.1	8.7	23.4	8.2	7.1
Queue Delay	0.0	0.0	0.0	0.0	0.0	0.0	0.0
Total Delay	24.0	2.3	29.1	8.7	23.4	8.2	7.1
Queue Length 50th (ft)	33	0	39	0	26	2	0
Queue Length 95th (ft)	107	31	136	32	102	47	37
Internal Link Dist (ft)	1242		359			627	
Turn Bay Length (ft)				545	325		
Base Capacity (vph)	2977	1410	3077	987	1243	1187	1134
Starvation Cap Reductn	0	0	0	0	0	0	0
Spillback Cap Reductn	0	0	0	0	0	0	0
Storage Cap Reductn	0	0	0	0	0	0	0
Reduced v/c Ratio	0.08	0.46	0.12	0.06	0.08	0.08	0.08
Intersection Summary							

Queues
1: Highway 76 & Olive Hill Road/Camino Del Rey

Existing + Project PM Peak Hour

07/10/2019

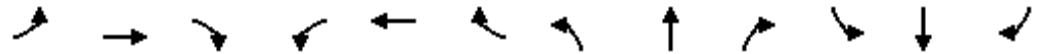

Lane Group	EBL	EBT	EBR	WBL	WBT	WBR	NBL	NBT	NBR	SBL	SBT	SBR
Lane Group Flow (vph)	114	61	126	163	120	308	142	2309	202	233	1349	50
v/c Ratio	0.40	0.39	0.51	0.62	0.43	0.68	0.68	0.87	0.23	0.69	0.53	0.06
Control Delay	83.2	87.8	19.5	79.1	71.4	21.0	92.9	42.2	10.2	88.4	32.6	2.4
Queue Delay	0.0	0.0	0.0	0.0	0.0	0.0	0.0	0.0	0.0	0.0	0.0	0.0
Total Delay	83.2	87.8	19.5	79.1	71.4	21.0	92.9	42.2	10.2	88.4	32.6	2.4
Queue Length 50th (ft)	62	65	0	175	125	52	155	786	36	130	350	0
Queue Length 95th (ft)	118	141	78	269	203	164	274	#1336	121	212	604	12
Internal Link Dist (ft)		415			1392			517			829	
Turn Bay Length (ft)	217		217	158		223	840		480	600		480
Base Capacity (vph)	476	258	328	542	571	662	307	2736	913	536	2648	859
Starvation Cap Reductn	0	0	0	0	0	0	0	0	0	0	0	0
Spillback Cap Reductn	0	0	0	0	0	0	0	0	0	0	0	0
Storage Cap Reductn	0	0	0	0	0	0	0	0	0	0	0	0
Reduced v/c Ratio	0.24	0.24	0.38	0.30	0.21	0.47	0.46	0.84	0.22	0.43	0.51	0.06

Intersection Summary

95th percentile volume exceeds capacity, queue may be longer.
Queue shown is maximum after two cycles.

Queues
4: Old Highway 395 & Highway 76

Existing + Project PM Peak Hour

07/10/2019



Lane Group	EBL	EBT	EBR	WBL	WBT	WBR	NBL	NBT	NBR	SBL	SBT
Lane Group Flow (vph)	165	1146	129	88	923	244	124	174	73	203	150
v/c Ratio	0.61	0.65	0.20	0.38	0.80	0.27	0.55	0.61	0.14	0.38	0.45
Control Delay	69.8	40.2	6.6	67.9	49.4	2.1	71.3	67.8	5.8	54.0	48.3
Queue Delay	0.0	0.0	0.0	0.0	0.0	0.0	0.0	0.0	0.0	0.0	0.0
Total Delay	69.8	40.2	6.6	67.9	49.4	2.1	71.3	67.8	5.8	54.0	48.3
Queue Length 50th (ft)	122	262	0	64	333	3	92	129	0	78	97
Queue Length 95th (ft)	320	553	55	187	721	26	245	324	25	152	210
Internal Link Dist (ft)		258			777			2696			2843
Turn Bay Length (ft)	325		500	410			320		195	340	
Base Capacity (vph)	378	2503	845	434	1822	1185	420	487	698	1659	891
Starvation Cap Reductn	0	0	0	0	7	0	0	0	0	0	0
Spillback Cap Reductn	0	0	0	0	0	0	0	0	0	0	0
Storage Cap Reductn	0	0	0	0	0	0	0	0	0	0	0
Reduced v/c Ratio	0.44	0.46	0.15	0.20	0.51	0.21	0.30	0.36	0.10	0.12	0.17

Intersection Summary

Queues
16: SR-76 & Old River Rd/East Vista Way

Existing + Project PM Peak Hour

07/10/2019



Lane Group	EBT	WBL	WBT	WBR	NBL	NBT	NBR	SBL	SBT
Lane Group Flow (vph)	189	124	125	679	67	1773	285	530	1056
v/c Ratio	0.59	0.69	0.68	0.92	0.52	0.77	0.33	0.68	0.34
Control Delay	34.3	98.0	96.9	52.7	97.5	43.2	5.3	69.1	17.8
Queue Delay	0.0	0.0	0.0	0.0	0.0	0.0	0.0	0.0	0.0
Total Delay	34.3	98.0	96.9	52.7	97.5	43.2	5.3	69.1	17.8
Queue Length 50th (ft)	33	156	157	575	81	629	14	307	207
Queue Length 95th (ft)	81	245	246	#864	145	761	79	402	293
Internal Link Dist (ft)	283		112			1144			2405
Turn Bay Length (ft)					835		540	385	
Base Capacity (vph)	654	367	374	759	305	2572	930	828	3211
Starvation Cap Reductn	0	0	0	0	0	0	0	0	0
Spillback Cap Reductn	0	0	0	0	0	0	0	0	0
Storage Cap Reductn	0	0	0	0	0	0	0	0	0
Reduced v/c Ratio	0.29	0.34	0.33	0.89	0.22	0.69	0.31	0.64	0.33

Intersection Summary

95th percentile volume exceeds capacity, queue may be longer.
Queue shown is maximum after two cycles.

Queues
17: SR-76 & N River Rd

Existing + Project PM Peak Hour
07/10/2019



Lane Group	EBL	EBR	NBL	NBT	SBT	SBR
Lane Group Flow (vph)	364	229	109	2340	1405	194
v/c Ratio	0.78	0.50	0.63	1.03	0.78	0.22
Control Delay	65.6	43.3	83.8	52.5	34.2	2.9
Queue Delay	0.0	0.0	0.0	0.0	0.0	0.0
Total Delay	65.6	43.3	83.8	52.5	34.2	2.9
Queue Length 50th (ft)	317	141	101	~1265	579	0
Queue Length 95th (ft)	#632	293	195	1343	730	40
Internal Link Dist (ft)	360			1017	712	
Turn Bay Length (ft)		70	770			685
Base Capacity (vph)	469	457	340	3420	2815	1298
Starvation Cap Reductn	0	0	0	0	0	0
Spillback Cap Reductn	0	0	0	0	0	0
Storage Cap Reductn	0	0	0	0	0	0
Reduced v/c Ratio	0.78	0.50	0.32	0.68	0.50	0.15

Intersection Summary

- ~ Volume exceeds capacity, queue is theoretically infinite.
Queue shown is maximum after two cycles.
- # 95th percentile volume exceeds capacity, queue may be longer.
Queue shown is maximum after two cycles.

Queues
18: SR-76 & Via Montellano

Existing + Project PM Peak Hour
07/10/2019



Lane Group	EBL	NBL	NBT	SBT	SBR
Lane Group Flow (vph)	8	11	2756	1628	5
v/c Ratio	0.04	0.08	0.87	0.52	0.00
Control Delay	38.8	59.3	13.4	8.1	5.6
Queue Delay	0.0	0.0	0.0	0.0	0.0
Total Delay	38.8	59.3	13.4	8.1	5.6
Queue Length 50th (ft)	3	7	0	0	0
Queue Length 95th (ft)	19	32	#1760	720	6
Internal Link Dist (ft)	324		613	589	
Turn Bay Length (ft)		565			445
Base Capacity (vph)	502	365	3365	3104	1389
Starvation Cap Reductn	0	0	0	0	0
Spillback Cap Reductn	0	0	0	0	0
Storage Cap Reductn	0	0	0	0	0
Reduced v/c Ratio	0.02	0.03	0.82	0.52	0.00

Intersection Summary

95th percentile volume exceeds capacity, queue may be longer.
Queue shown is maximum after two cycles.

Queues
19: I-15 SB Ramps & Highway 76

Existing + Project PM Peak Hour
07/10/2019



Lane Group	EBT	EBR	WBT	WBR	SBL	SBT	SBR
Lane Group Flow (vph)	1092	211	693	128	52	365	359
v/c Ratio	0.61	0.30	0.68	0.15	0.23	0.72	0.70
Control Delay	29.4	4.9	37.4	3.1	45.6	14.1	12.7
Queue Delay	0.0	0.0	0.0	0.0	0.0	0.0	0.0
Total Delay	29.4	4.9	37.4	3.1	45.6	14.1	12.7
Queue Length 50th (ft)	200	0	196	0	30	3	0
Queue Length 95th (ft)	347	54	373	31	85	114	100
Internal Link Dist (ft)	777		1242			680	
Turn Bay Length (ft)		600			400		
Base Capacity (vph)	2925	1000	2147	1398	879	926	958
Starvation Cap Reductn	0	0	0	0	0	0	0
Spillback Cap Reductn	0	0	0	0	0	0	0
Storage Cap Reductn	0	0	0	0	0	0	0
Reduced v/c Ratio	0.37	0.21	0.32	0.09	0.06	0.39	0.37
Intersection Summary							

Queues
20: I-15 NB Ramps & Highway 76

Existing + Project PM Peak Hour

07/10/2019



Lane Group	EBT	EBR	WBT	WBR	NBL	NBT	NBR
Lane Group Flow (vph)	496	646	344	53	395	412	414
v/c Ratio	0.62	0.49	0.49	0.19	0.58	0.54	0.48
Control Delay	37.5	1.7	42.5	6.1	28.2	11.0	4.6
Queue Delay	0.0	0.0	0.0	0.0	0.0	0.0	0.0
Total Delay	37.5	1.7	42.5	6.1	28.2	11.0	4.6
Queue Length 50th (ft)	150	0	73	0	176	52	0
Queue Length 95th (ft)	223	31	126	20	414	213	75
Internal Link Dist (ft)	1242		359			627	
Turn Bay Length (ft)				545	325		
Base Capacity (vph)	1967	1314	1995	667	806	845	936
Starvation Cap Reductn	0	0	0	0	0	0	0
Spillback Cap Reductn	0	0	0	0	0	0	0
Storage Cap Reductn	0	0	0	0	0	0	0
Reduced v/c Ratio	0.25	0.49	0.17	0.08	0.49	0.49	0.44
Intersection Summary							

Queues
1: Highway 76 & Olive Hill Road/Camino Del Rey

Existing + Cumulative Projects AM
07/10/2019



Lane Group	EBL	EBT	EBR	WBL	WBT	WBR	NBL	NBT	NBR	SBL	SBT	SBR
Lane Group Flow (vph)	165	385	271	197	222	262	151	1618	283	658	3208	255
v/c Ratio	0.32	1.39	0.82	0.71	0.77	0.62	0.81	0.85	0.39	0.91	1.32	0.31
Control Delay	93.0	259.7	76.5	107.8	111.3	26.4	133.1	72.5	15.6	106.4	191.9	22.3
Queue Delay	0.0	0.0	0.0	0.0	0.0	0.0	0.0	0.0	0.0	0.0	0.0	0.0
Total Delay	93.0	259.7	76.5	107.8	111.3	26.4	133.1	72.5	15.6	106.4	191.9	22.3
Queue Length 50th (ft)	121	-810	258	301	342	76	235	847	75	520	-2309	130
Queue Length 95th (ft)	180	#1150	#464	406	453	189	350	1011	182	#688	#2653	241
Internal Link Dist (ft)		415			1392			820			829	
Turn Bay Length (ft)	217		217	158		223	840		480	600		480
Base Capacity (vph)	510	276	329	410	431	527	232	2000	750	780	2523	841
Starvation Cap Reductn	0	0	0	0	0	0	0	0	0	0	0	0
Spillback Cap Reductn	0	0	0	0	0	0	0	0	0	0	0	0
Storage Cap Reductn	0	0	0	0	0	0	0	0	0	0	0	0
Reduced v/c Ratio	0.32	1.39	0.82	0.48	0.52	0.50	0.65	0.81	0.38	0.84	1.27	0.30

Intersection Summary

- ~ Volume exceeds capacity, queue is theoretically infinite.
Queue shown is maximum after two cycles.
- # 95th percentile volume exceeds capacity, queue may be longer.
Queue shown is maximum after two cycles.

Queues
4: Old Highway 395 & Highway 76

Existing + Cumulative Projects AM

07/10/2019



Lane Group	EBL	EBT	EBR	WBL	WBT	WBR	NBL	NBT	NBR	SBL	SBT
Lane Group Flow (vph)	123	1119	327	366	1480	153	351	276	227	319	766
v/c Ratio	0.71	0.81	0.49	1.39	1.29	0.15	1.38	0.96	0.39	0.31	1.38
Control Delay	113.0	75.7	7.3	256.1	190.3	3.7	251.8	127.3	13.8	58.7	231.7
Queue Delay	0.0	0.0	0.0	0.0	0.2	0.0	0.0	0.0	0.0	0.0	0.0
Total Delay	113.0	75.7	7.3	256.1	190.5	3.7	251.8	127.3	13.8	58.7	231.7
Queue Length 50th (ft)	170	530	0	~680	~1343	18	~649	388	49	181	~1413
Queue Length 95th (ft)	247	588	86	#917	#1562	37	#883	#594	91	232	#1694
Internal Link Dist (ft)		258			777			2696			2843
Turn Bay Length (ft)	325		500	410			320		195	340	
Base Capacity (vph)	229	1488	694	263	1146	1028	255	294	583	1014	555
Starvation Cap Reductn	0	0	0	0	56	0	0	0	0	0	0
Spillback Cap Reductn	0	0	0	0	0	0	0	0	0	0	0
Storage Cap Reductn	0	0	0	0	0	0	0	0	0	0	0
Reduced v/c Ratio	0.54	0.75	0.47	1.39	1.36	0.15	1.38	0.94	0.39	0.31	1.38

Intersection Summary

- ~ Volume exceeds capacity, queue is theoretically infinite.
Queue shown is maximum after two cycles.
- # 95th percentile volume exceeds capacity, queue may be longer.
Queue shown is maximum after two cycles.

Queues
16: SR-76 & Old River Rd/East Vista Way

Existing + Cumulative Projects AM
07/10/2019



Lane Group	EBT	WBL	WBT	WBR	NBL	NBT	NBR	SBL	SBT
Lane Group Flow (vph)	413	202	202	427	133	1250	513	754	2504
v/c Ratio	0.84	0.82	0.81	0.54	0.72	0.67	0.59	0.98	1.02
Control Delay	77.0	106.2	104.3	21.0	106.3	52.9	9.2	98.4	69.8
Queue Delay	0.0	0.0	0.0	0.0	0.0	0.0	0.0	0.0	0.0
Total Delay	77.0	106.2	104.3	21.0	106.3	52.9	9.2	98.4	69.8
Queue Length 50th (ft)	197	255	254	167	160	481	48	478	~1209
Queue Length 95th (ft)	308	415	414	339	276	598	174	#819	#1585
Internal Link Dist (ft)	283		112			1144			2405
Turn Bay Length (ft)					835		540	385	
Base Capacity (vph)	611	341	347	787	284	2394	986	771	2709
Starvation Cap Reductn	0	0	0	0	0	0	0	0	0
Spillback Cap Reductn	0	0	0	0	0	0	0	0	0
Storage Cap Reductn	0	0	0	0	0	0	0	0	0
Reduced v/c Ratio	0.68	0.59	0.58	0.54	0.47	0.52	0.52	0.98	0.92

Intersection Summary

- ~ Volume exceeds capacity, queue is theoretically infinite.
Queue shown is maximum after two cycles.
- # 95th percentile volume exceeds capacity, queue may be longer.
Queue shown is maximum after two cycles.

Queues
17: SR-76 & N River Rd



Lane Group	EBL	EBR	NBL	NBT	SBT	SBR
Lane Group Flow (vph)	188	151	145	1808	3134	571
v/c Ratio	0.79	0.56	0.74	0.65	1.36	0.49
Control Delay	101.1	50.5	103.2	10.1	194.9	6.5
Queue Delay	0.0	0.0	0.0	0.0	0.0	0.0
Total Delay	101.1	50.5	103.2	10.1	194.9	6.5
Queue Length 50th (ft)	224	99	174	440	~2619	82
Queue Length 95th (ft)	336	188	271	633	#3097	212
Internal Link Dist (ft)	360			1017	712	
Turn Bay Length (ft)		70	770			685
Base Capacity (vph)	383	393	278	2966	2301	1169
Starvation Cap Reductn	0	0	0	0	0	0
Spillback Cap Reductn	0	0	0	0	0	0
Storage Cap Reductn	0	0	0	0	0	0
Reduced v/c Ratio	0.49	0.38	0.52	0.61	1.36	0.49

Intersection Summary

- ~ Volume exceeds capacity, queue is theoretically infinite.
Queue shown is maximum after two cycles.
- # 95th percentile volume exceeds capacity, queue may be longer.
Queue shown is maximum after two cycles.



Lane Group	EBL	NBL	NBT	SBT	SBR
Lane Group Flow (vph)	15	3	1986	3555	9
v/c Ratio	0.07	0.02	0.63	1.15	0.01
Control Delay	34.2	59.7	7.0	82.6	6.3
Queue Delay	0.0	0.0	0.0	0.0	0.0
Total Delay	34.2	59.7	7.0	82.6	6.3
Queue Length 50th (ft)	5	2	0	-12	0
Queue Length 95th (ft)	26	14	795	#2764	10
Internal Link Dist (ft)	324		613	589	
Turn Bay Length (ft)		565			445
Base Capacity (vph)	495	360	3365	3104	1389
Starvation Cap Reductn	0	0	0	0	0
Spillback Cap Reductn	0	0	0	0	0
Storage Cap Reductn	0	0	0	0	0
Reduced v/c Ratio	0.03	0.01	0.59	1.15	0.01

Intersection Summary

- ~ Volume exceeds capacity, queue is theoretically infinite.
Queue shown is maximum after two cycles.
- # 95th percentile volume exceeds capacity, queue may be longer.
Queue shown is maximum after two cycles.

Queues
19: I-15 SB Ramps & Highway 76



Lane Group	EBT	EBR	WBT	WBR	SBL	SBT	SBR
Lane Group Flow (vph)	1593	167	992	215	49	744	738
v/c Ratio	1.00	0.27	0.91	0.20	0.11	0.96	0.93
Control Delay	83.0	7.0	72.5	1.9	51.1	41.3	36.2
Queue Delay	0.0	0.0	0.0	0.0	0.0	0.0	0.0
Total Delay	83.0	7.0	72.5	1.9	51.1	41.3	36.2
Queue Length 50th (ft)	~763	0	605	0	47	363	320
Queue Length 95th (ft)	#857	61	699	34	89	#703	#635
Internal Link Dist (ft)	777		1242			680	
Turn Bay Length (ft)		600			400		
Base Capacity (vph)	1589	609	1166	1081	477	795	813
Starvation Cap Reductn	0	0	0	0	0	0	0
Spillback Cap Reductn	0	0	0	0	0	0	0
Storage Cap Reductn	0	0	0	0	0	0	0
Reduced v/c Ratio	1.00	0.27	0.85	0.20	0.10	0.94	0.91

Intersection Summary

- ~ Volume exceeds capacity, queue is theoretically infinite.
Queue shown is maximum after two cycles.
- # 95th percentile volume exceeds capacity, queue may be longer.
Queue shown is maximum after two cycles.

Queues
20: I-15 NB Ramps & Highway 76

Existing + Cumulative Projects AM
07/10/2019



Lane Group	EBT	EBR	WBT	WBR	NBL	NBT	NBR
Lane Group Flow (vph)	974	645	959	105	96	95	88
v/c Ratio	0.78	0.54	0.68	0.20	0.34	0.28	0.27
Control Delay	38.8	2.5	40.4	8.7	44.9	12.8	10.5
Queue Delay	0.0	0.0	0.0	0.0	0.0	0.0	0.0
Total Delay	38.8	2.5	40.4	8.7	44.9	12.8	10.5
Queue Length 50th (ft)	304	0	208	0	63	5	0
Queue Length 95th (ft)	556	39	386	50	129	57	46
Internal Link Dist (ft)	1242		359			627	
Turn Bay Length (ft)				545	325		
Base Capacity (vph)	1735	1206	1760	616	711	716	687
Starvation Cap Reductn	0	0	0	0	0	0	0
Spillback Cap Reductn	0	0	0	0	0	0	0
Storage Cap Reductn	0	0	0	0	0	0	0
Reduced v/c Ratio	0.56	0.53	0.54	0.17	0.14	0.13	0.13
Intersection Summary							

Queues
1: Highway 76 & Olive Hill Road/Camino Del Rey

Existing + Cumulative Projects PM

07/10/2019



Lane Group	EBL	EBT	EBR	WBL	WBT	WBR	NBL	NBT	NBR	SBL	SBT	SBR
Lane Group Flow (vph)	143	257	357	224	221	417	278	3154	291	340	1989	180
v/c Ratio	0.36	1.18	0.89	0.72	0.67	0.87	1.07	1.34	0.36	0.84	0.90	0.23
Control Delay	88.4	190.2	52.1	92.4	88.9	52.6	154.5	196.0	20.0	108.3	60.6	11.3
Queue Delay	0.0	0.0	0.0	0.0	0.0	0.0	0.0	0.0	0.0	0.0	0.0	0.0
Total Delay	88.4	190.2	52.1	92.4	88.9	52.6	154.5	196.0	20.0	108.3	60.6	11.3
Queue Length 50th (ft)	93	-412	164	291	284	256	-413	-2021	125	233	902	34
Queue Length 95th (ft)	146	#687	#393	395	385	407	#697	#2344	239	321	1109	103
Internal Link Dist (ft)		415			1392			517			829	
Turn Bay Length (ft)	217		217	158		223	840		480	600		480
Base Capacity (vph)	401	217	400	457	481	588	259	2361	811	452	2231	771
Starvation Cap Reductn	0	0	0	0	0	0	0	0	0	0	0	0
Spillback Cap Reductn	0	0	0	0	0	0	0	0	0	0	0	0
Storage Cap Reductn	0	0	0	0	0	0	0	0	0	0	0	0
Reduced v/c Ratio	0.36	1.18	0.89	0.49	0.46	0.71	1.07	1.34	0.36	0.75	0.89	0.23

Intersection Summary

~ Volume exceeds capacity, queue is theoretically infinite.

Queue shown is maximum after two cycles.

95th percentile volume exceeds capacity, queue may be longer.

Queue shown is maximum after two cycles.

Queues
4: Old Highway 395 & Highway 76



Lane Group	EBL	EBT	EBR	WBL	WBT	WBR	NBL	NBT	NBR	SBL	SBT
Lane Group Flow (vph)	224	1387	221	127	1506	395	288	370	140	340	369
v/c Ratio	0.91	0.73	0.30	0.70	1.27	0.43	1.05	1.16	0.28	0.46	0.88
Control Delay	118.0	56.8	6.7	105.3	176.1	11.1	142.2	168.2	13.2	67.3	91.6
Queue Delay	0.0	0.0	0.0	0.0	0.1	0.0	0.0	0.0	0.0	0.0	0.0
Total Delay	118.0	56.8	6.7	105.3	176.2	11.1	142.2	168.2	13.2	67.3	91.6
Queue Length 50th (ft)	284	549	3	159	~1248	116	~392	~549	34	196	449
Queue Length 95th (ft)	#523	750	77	254	#1600	157	#689	#884	62	248	581
Internal Link Dist (ft)		258			777			2696			2843
Turn Bay Length (ft)	325		500	410			320		195	340	
Base Capacity (vph)	247	1898	726	284	1190	1072	275	318	593	1083	597
Starvation Cap Reductn	0	0	0	0	18	0	0	0	0	0	0
Spillback Cap Reductn	0	0	0	0	0	0	0	0	0	0	0
Storage Cap Reductn	0	0	0	0	0	0	0	0	0	0	0
Reduced v/c Ratio	0.91	0.73	0.30	0.45	1.28	0.37	1.05	1.16	0.24	0.31	0.62

Intersection Summary

- ~ Volume exceeds capacity, queue is theoretically infinite.
Queue shown is maximum after two cycles.
- # 95th percentile volume exceeds capacity, queue may be longer.
Queue shown is maximum after two cycles.

Queues
16: SR-76 & Old River Rd/East Vista Way



Lane Group	EBT	WBL	WBT	WBR	NBL	NBT	NBR	SBL	SBT
Lane Group Flow (vph)	276	155	159	913	198	2652	543	566	2038
v/c Ratio	0.75	0.78	0.76	1.26	0.83	1.14	0.60	0.75	0.74
Control Delay	49.5	107.5	105.8	166.3	109.0	114.9	17.3	78.8	37.7
Queue Delay	0.0	0.0	0.0	0.0	0.0	0.0	0.0	0.0	0.0
Total Delay	49.5	107.5	105.8	166.3	109.0	114.9	17.3	78.8	37.7
Queue Length 50th (ft)	75	203	208	~1262	245	~1416	194	348	720
Queue Length 95th (ft)	137	306	312	#1609	#389	#1679	367	461	930
Internal Link Dist (ft)	283		112			1144			2405
Turn Bay Length (ft)					835		540	385	
Base Capacity (vph)	633	332	344	722	276	2327	906	750	2748
Starvation Cap Reductn	0	0	0	0	0	0	0	0	0
Spillback Cap Reductn	0	0	0	0	0	0	0	0	0
Storage Cap Reductn	0	0	0	0	0	0	0	0	0
Reduced v/c Ratio	0.44	0.47	0.46	1.26	0.72	1.14	0.60	0.75	0.74

Intersection Summary

- ~ Volume exceeds capacity, queue is theoretically infinite.
Queue shown is maximum after two cycles.
- # 95th percentile volume exceeds capacity, queue may be longer.
Queue shown is maximum after two cycles.

Queues
17: SR-76 & N River Rd



Lane Group	EBL	EBR	NBL	NBT	SBT	SBR
Lane Group Flow (vph)	357	229	109	3465	2423	192
v/c Ratio	0.99	0.63	0.70	1.35	1.12	0.19
Control Delay	121.5	64.1	110.0	184.7	97.9	3.3
Queue Delay	0.0	0.0	0.0	0.0	0.0	0.0
Total Delay	121.5	64.1	110.0	184.7	97.9	3.3
Queue Length 50th (ft)	468	214	140	~3068	~1893	9
Queue Length 95th (ft)	#734	333	216	#3181	#2105	48
Internal Link Dist (ft)	360			1017	712	
Turn Bay Length (ft)		70	770			685
Base Capacity (vph)	359	363	260	2783	2159	1033
Starvation Cap Reductn	0	0	0	0	0	0
Spillback Cap Reductn	0	0	0	0	0	0
Storage Cap Reductn	0	0	0	0	0	0
Reduced v/c Ratio	0.99	0.63	0.42	1.25	1.12	0.19

Intersection Summary

- ~ Volume exceeds capacity, queue is theoretically infinite.
Queue shown is maximum after two cycles.
- # 95th percentile volume exceeds capacity, queue may be longer.
Queue shown is maximum after two cycles.



Lane Group	EBL	NBL	NBT	SBT	SBR
Lane Group Flow (vph)	8	11	3899	2665	5
v/c Ratio	0.04	0.08	1.23	0.86	0.00
Control Delay	38.9	59.6	118.8	14.8	6.6
Queue Delay	0.0	0.0	0.0	0.0	0.0
Total Delay	38.9	59.6	118.8	14.8	6.6
Queue Length 50th (ft)	3	7	-277	0	0
Queue Length 95th (ft)	19	32	#2930	#1851	7
Internal Link Dist (ft)	324		613	589	
Turn Bay Length (ft)		565			445
Base Capacity (vph)	496	360	3365	3104	1389
Starvation Cap Reductn	0	0	0	0	0
Spillback Cap Reductn	0	0	0	0	0
Storage Cap Reductn	0	0	0	0	0
Reduced v/c Ratio	0.02	0.03	1.16	0.86	0.00

Intersection Summary

- ~ Volume exceeds capacity, queue is theoretically infinite.
Queue shown is maximum after two cycles.
- # 95th percentile volume exceeds capacity, queue may be longer.
Queue shown is maximum after two cycles.

Queues
19: I-15 SB Ramps & Highway 76



Lane Group	EBT	EBR	WBT	WBR	SBL	SBT	SBR
Lane Group Flow (vph)	1519	211	1445	209	456	435	424
v/c Ratio	1.00	0.34	1.30	0.20	1.00	0.95	0.59
Control Delay	86.5	6.7	188.5	4.1	107.3	84.7	7.7
Queue Delay	0.0	0.0	0.0	0.0	0.0	0.0	0.0
Total Delay	86.5	6.7	188.5	4.1	107.3	84.7	7.7
Queue Length 50th (ft)	678	0	~1168	23	586	496	0
Queue Length 95th (ft)	#791	66	#1306	59	#847	#749	104
Internal Link Dist (ft)	777		1242			680	
Turn Bay Length (ft)		600			400		
Base Capacity (vph)	1519	620	1114	1052	456	459	717
Starvation Cap Reductn	0	0	0	0	0	0	0
Spillback Cap Reductn	0	0	0	0	0	0	0
Storage Cap Reductn	0	0	0	0	0	0	0
Reduced v/c Ratio	1.00	0.34	1.30	0.20	1.00	0.95	0.59

Intersection Summary

- ~ Volume exceeds capacity, queue is theoretically infinite.
Queue shown is maximum after two cycles.
- # 95th percentile volume exceeds capacity, queue may be longer.
Queue shown is maximum after two cycles.

Queues
20: I-15 NB Ramps & Highway 76



Lane Group	EBT	EBR	WBT	WBR	NBL	NBT	NBR
Lane Group Flow (vph)	1479	641	1178	87	395	1027	1023
v/c Ratio	1.25	0.50	0.98	0.20	0.81	1.39	1.35
Control Delay	160.4	2.1	78.6	9.6	64.6	205.8	190.2
Queue Delay	0.0	0.0	0.0	0.0	0.0	0.0	0.0
Total Delay	160.4	2.1	78.6	9.6	64.6	205.8	190.2
Queue Length 50th (ft)	~958	0	429	0	385	~1119	~1045
Queue Length 95th (ft)	#1098	39	#532	47	#553	#1413	#1326
Internal Link Dist (ft)	1242		359			627	
Turn Bay Length (ft)				545	325		
Base Capacity (vph)	1186	1275	1203	441	486	740	757
Starvation Cap Reductn	0	0	0	0	0	0	0
Spillback Cap Reductn	0	0	0	0	0	0	0
Storage Cap Reductn	0	0	0	0	0	0	0
Reduced v/c Ratio	1.25	0.50	0.98	0.20	0.81	1.39	1.35

Intersection Summary

- ~ Volume exceeds capacity, queue is theoretically infinite.
Queue shown is maximum after two cycles.
- # 95th percentile volume exceeds capacity, queue may be longer.
Queue shown is maximum after two cycles.

Queues
1: Highway 76 & Olive Hill Road/Camino Del Rey

Existing + Cumulative + Project AM
07/10/2019



Lane Group	EBL	EBT	EBR	WBL	WBT	WBR	NBL	NBT	NBR	SBL	SBT	SBR
Lane Group Flow (vph)	165	385	271	248	222	272	151	1618	304	662	3208	255
v/c Ratio	0.33	1.43	0.84	0.82	0.69	0.60	0.82	0.87	0.42	0.93	1.34	0.32
Control Delay	95.8	275.0	80.1	116.0	104.4	25.2	136.9	76.2	16.2	111.6	202.6	23.4
Queue Delay	0.0	0.0	0.0	0.0	0.0	0.0	0.0	0.0	0.0	0.0	0.0	0.0
Total Delay	95.8	275.0	80.1	116.0	104.4	25.2	136.9	76.2	16.2	111.6	202.6	23.4
Queue Length 50th (ft)	125	-846	267	391	342	79	242	887	86	543	-2425	139
Queue Length 95th (ft)	180	#1150	#464	512	453	195	350	1011	195	#695	#2653	241
Internal Link Dist (ft)		415			1392			820			829	
Turn Bay Length (ft)	217		217	158		223	840		480	600		480
Base Capacity (vph)	496	269	323	399	420	525	226	1948	746	759	2463	824
Starvation Cap Reductn	0	0	0	0	0	0	0	0	0	0	0	0
Spillback Cap Reductn	0	0	0	0	0	0	0	0	0	0	0	0
Storage Cap Reductn	0	0	0	0	0	0	0	0	0	0	0	0
Reduced v/c Ratio	0.33	1.43	0.84	0.62	0.53	0.52	0.67	0.83	0.41	0.87	1.30	0.31

Intersection Summary

- ~ Volume exceeds capacity, queue is theoretically infinite.
Queue shown is maximum after two cycles.
- # 95th percentile volume exceeds capacity, queue may be longer.
Queue shown is maximum after two cycles.

Queues
4: Old Highway 395 & Highway 76

Existing + Cumulative + Project AM
07/10/2019



Lane Group	EBL	EBT	EBR	WBL	WBT	WBR	NBL	NBT	NBR	SBL	SBT
Lane Group Flow (vph)	123	1119	330	382	1480	153	358	283	265	319	769
v/c Ratio	0.71	0.81	0.49	1.45	1.29	0.15	1.40	0.96	0.45	0.32	1.39
Control Delay	113.0	75.7	7.3	279.0	190.3	3.7	261.9	127.9	16.8	59.0	233.8
Queue Delay	0.0	0.0	0.0	0.0	0.2	0.0	0.0	0.0	0.0	0.0	0.0
Total Delay	113.0	75.7	7.3	279.0	190.5	3.7	261.9	127.9	16.8	59.0	233.8
Queue Length 50th (ft)	170	530	0	~726	~1343	18	~669	399	70	181	~1422
Queue Length 95th (ft)	247	588	88	#967	#1562	37	#903	#615	119	232	#1702
Internal Link Dist (ft)		258			777			2696			2843
Turn Bay Length (ft)	325		500	410			320		195	340	
Base Capacity (vph)	229	1488	696	263	1146	1024	255	294	588	1004	555
Starvation Cap Reductn	0	0	0	0	56	0	0	0	0	0	0
Spillback Cap Reductn	0	0	0	0	0	0	0	0	0	0	0
Storage Cap Reductn	0	0	0	0	0	0	0	0	0	0	0
Reduced v/c Ratio	0.54	0.75	0.47	1.45	1.36	0.15	1.40	0.96	0.45	0.32	1.39

Intersection Summary

- ~ Volume exceeds capacity, queue is theoretically infinite.
Queue shown is maximum after two cycles.
- # 95th percentile volume exceeds capacity, queue may be longer.
Queue shown is maximum after two cycles.

Queues
16: SR-76 & Old River Rd/East Vista Way

Existing + Cumulative + Project AM
07/10/2019



Lane Group	EBT	WBL	WBT	WBR	NBL	NBT	NBR	SBL	SBT
Lane Group Flow (vph)	413	202	202	432	133	1265	513	766	2536
v/c Ratio	0.84	0.82	0.81	0.55	0.72	0.68	0.59	1.00	1.03
Control Delay	77.1	106.4	104.6	21.5	106.4	53.2	9.2	102.5	73.1
Queue Delay	0.0	0.0	0.0	0.0	0.0	0.0	0.0	0.0	0.0
Total Delay	77.1	106.4	104.6	21.5	106.4	53.2	9.2	102.5	73.1
Queue Length 50th (ft)	198	256	255	174	161	489	48	491	~1242
Queue Length 95th (ft)	308	415	414	347	276	607	174	#838	#1619
Internal Link Dist (ft)	283		112			1144			2405
Turn Bay Length (ft)					835		540	385	
Base Capacity (vph)	610	341	346	786	283	2389	985	769	2704
Starvation Cap Reductn	0	0	0	0	0	0	0	0	0
Spillback Cap Reductn	0	0	0	0	0	0	0	0	0
Storage Cap Reductn	0	0	0	0	0	0	0	0	0
Reduced v/c Ratio	0.68	0.59	0.58	0.55	0.47	0.53	0.52	1.00	0.94

Intersection Summary

- ~ Volume exceeds capacity, queue is theoretically infinite.
Queue shown is maximum after two cycles.
- # 95th percentile volume exceeds capacity, queue may be longer.
Queue shown is maximum after two cycles.

Queues
17: SR-76 & N River Rd



Lane Group	EBL	EBR	NBL	NBT	SBT	SBR
Lane Group Flow (vph)	191	151	145	1827	3178	575
v/c Ratio	0.80	0.56	0.74	0.65	1.38	0.49
Control Delay	101.3	50.8	103.5	10.4	204.3	6.7
Queue Delay	0.0	0.0	0.0	0.0	0.0	0.0
Total Delay	101.3	50.8	103.5	10.4	204.3	6.7
Queue Length 50th (ft)	229	100	174	453	~2684	88
Queue Length 95th (ft)	341	190	272	655	#3168	223
Internal Link Dist (ft)	360			1017	712	
Turn Bay Length (ft)		70	770			685
Base Capacity (vph)	383	392	277	2962	2297	1167
Starvation Cap Reductn	0	0	0	0	0	0
Spillback Cap Reductn	0	0	0	0	0	0
Storage Cap Reductn	0	0	0	0	0	0
Reduced v/c Ratio	0.50	0.39	0.52	0.62	1.38	0.49

Intersection Summary

- ~ Volume exceeds capacity, queue is theoretically infinite.
Queue shown is maximum after two cycles.
- # 95th percentile volume exceeds capacity, queue may be longer.
Queue shown is maximum after two cycles.



Lane Group	EBL	NBL	NBT	SBT	SBR
Lane Group Flow (vph)	15	3	2006	3603	9
v/c Ratio	0.07	0.02	0.63	1.16	0.01
Control Delay	34.2	59.7	7.1	89.4	6.3
Queue Delay	0.0	0.0	0.0	0.0	0.0
Total Delay	34.2	59.7	7.1	89.4	6.3
Queue Length 50th (ft)	5	2	0	-49	0
Queue Length 95th (ft)	26	14	815	#2813	10
Internal Link Dist (ft)	324		613	589	
Turn Bay Length (ft)		565			445
Base Capacity (vph)	495	360	3365	3104	1389
Starvation Cap Reductn	0	0	0	0	0
Spillback Cap Reductn	0	0	0	0	0
Storage Cap Reductn	0	0	0	0	0
Reduced v/c Ratio	0.03	0.01	0.60	1.16	0.01

Intersection Summary

~ Volume exceeds capacity, queue is theoretically infinite.
Queue shown is maximum after two cycles.

95th percentile volume exceeds capacity, queue may be longer.
Queue shown is maximum after two cycles.

Queues
19: I-15 SB Ramps & Highway 76



Lane Group	EBT	EBR	WBT	WBR	SBL	SBT	SBR
Lane Group Flow (vph)	1633	167	1005	215	49	746	740
v/c Ratio	1.03	0.28	0.92	0.20	0.11	0.96	0.94
Control Delay	90.2	7.0	73.5	1.9	51.2	42.0	36.8
Queue Delay	0.0	0.0	0.0	0.0	0.0	0.0	0.0
Total Delay	90.2	7.0	73.5	1.9	51.2	42.0	36.8
Queue Length 50th (ft)	~800	0	616	0	47	370	326
Queue Length 95th (ft)	#893	61	712	34	89	#714	#643
Internal Link Dist (ft)	777		1242			680	
Turn Bay Length (ft)		600			400		
Base Capacity (vph)	1581	607	1159	1081	475	793	811
Starvation Cap Reductn	0	0	0	0	0	0	0
Spillback Cap Reductn	0	0	0	0	0	0	0
Storage Cap Reductn	0	0	0	0	0	0	0
Reduced v/c Ratio	1.03	0.28	0.87	0.20	0.10	0.94	0.91

Intersection Summary

- ~ Volume exceeds capacity, queue is theoretically infinite.
Queue shown is maximum after two cycles.
- # 95th percentile volume exceeds capacity, queue may be longer.
Queue shown is maximum after two cycles.

Queues
20: I-15 NB Ramps & Highway 76

Existing + Cumulative + Project AM
07/10/2019



Lane Group	EBT	EBR	WBT	WBR	NBL	NBT	NBR
Lane Group Flow (vph)	1002	654	972	105	96	95	88
v/c Ratio	0.79	0.54	0.69	0.20	0.34	0.28	0.27
Control Delay	39.2	2.5	41.2	8.7	45.8	12.9	10.6
Queue Delay	0.0	0.0	0.0	0.0	0.0	0.0	0.0
Total Delay	39.2	2.5	41.2	8.7	45.8	12.9	10.6
Queue Length 50th (ft)	322	0	219	0	65	6	0
Queue Length 95th (ft)	577	39	393	50	129	57	46
Internal Link Dist (ft)	1242		359			627	
Turn Bay Length (ft)				545	325		
Base Capacity (vph)	1702	1209	1727	607	697	704	675
Starvation Cap Reductn	0	0	0	0	0	0	0
Spillback Cap Reductn	0	0	0	0	0	0	0
Storage Cap Reductn	0	0	0	0	0	0	0
Reduced v/c Ratio	0.59	0.54	0.56	0.17	0.14	0.13	0.13
Intersection Summary							

Queues

Existing + Cumulative + Project PM

1: Highway 76 & Olive Hill Road/Camino Del Rey

07/10/2019

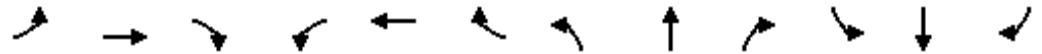

Lane Group	EBL	EBT	EBR	WBL	WBT	WBR	NBL	NBT	NBR	SBL	SBT	SBR
Lane Group Flow (vph)	143	257	357	250	221	422	278	3154	351	351	1989	180
v/c Ratio	0.36	1.20	0.89	0.77	0.64	0.86	1.09	1.36	0.43	0.86	0.90	0.24
Control Delay	89.3	194.9	52.8	95.9	87.0	52.1	158.5	205.1	21.4	109.6	62.1	11.4
Queue Delay	0.0	0.0	0.0	0.0	0.0	0.0	0.0	0.0	0.0	0.0	0.0	0.0
Total Delay	89.3	194.9	52.8	95.9	87.0	52.1	158.5	205.1	21.4	109.6	62.1	11.4
Queue Length 50th (ft)	94	-421	166	330	284	265	-423	-2077	164	243	923	35
Queue Length 95th (ft)	146	#687	#393	443	385	418	#697	#2344	292	#343	1109	103
Internal Link Dist (ft)		415			1392			517			829	
Turn Bay Length (ft)	217		217	158		223	840		480	600		480
Base Capacity (vph)	397	215	399	452	476	584	256	2326	817	447	2207	764
Starvation Cap Reductn	0	0	0	0	0	0	0	0	0	0	0	0
Spillback Cap Reductn	0	0	0	0	0	0	0	0	0	0	0	0
Storage Cap Reductn	0	0	0	0	0	0	0	0	0	0	0	0
Reduced v/c Ratio	0.36	1.20	0.89	0.55	0.46	0.72	1.09	1.36	0.43	0.79	0.90	0.24

Intersection Summary

- ~ Volume exceeds capacity, queue is theoretically infinite.
Queue shown is maximum after two cycles.
- # 95th percentile volume exceeds capacity, queue may be longer.
Queue shown is maximum after two cycles.

Queues
4: Old Highway 395 & Highway 76

Existing + Cumulative + Project PM

07/10/2019



Lane Group	EBL	EBT	EBR	WBL	WBT	WBR	NBL	NBT	NBR	SBL	SBT
Lane Group Flow (vph)	224	1387	230	174	1506	395	293	374	161	340	378
v/c Ratio	0.91	0.77	0.33	0.81	1.27	0.43	1.07	1.18	0.30	0.45	0.89
Control Delay	119.2	61.0	7.2	111.3	178.6	11.1	148.1	174.1	12.6	67.0	92.3
Queue Delay	0.0	0.0	0.0	0.0	0.1	0.0	0.0	0.0	0.0	0.0	0.0
Total Delay	119.2	61.0	7.2	111.3	178.6	11.1	148.1	174.1	12.6	67.0	92.3
Queue Length 50th (ft)	285	578	3	219	~1261	116	~409	~565	37	196	462
Queue Length 95th (ft)	#523	#789	81	333	#1600	157	#704	#898	67	248	598
Internal Link Dist (ft)		258			777			2696			2843
Turn Bay Length (ft)	325		500	410			320		195	340	
Base Capacity (vph)	246	1793	704	282	1185	1067	273	316	598	1079	596
Starvation Cap Reductn	0	0	0	0	18	0	0	0	0	0	0
Spillback Cap Reductn	0	0	0	0	0	0	0	0	0	0	0
Storage Cap Reductn	0	0	0	0	0	0	0	0	0	0	0
Reduced v/c Ratio	0.91	0.77	0.33	0.62	1.29	0.37	1.07	1.18	0.27	0.32	0.63

Intersection Summary

- ~ Volume exceeds capacity, queue is theoretically infinite.
Queue shown is maximum after two cycles.
- # 95th percentile volume exceeds capacity, queue may be longer.
Queue shown is maximum after two cycles.

Queues
11: Old Highway 395 & Gopher Canyon Road

Existing + Cumulative + Project PM
07/10/2019



Lane Group	EBL	EBR	NBL	NBT	SBT	SBR
Lane Group Flow (vph)	707	260	289	406	288	398
v/c Ratio	1.57	0.26	0.72	0.37	0.54	0.54
Control Delay	291.7	2.1	33.3	6.4	19.4	4.8
Queue Delay	0.0	0.0	0.0	0.0	0.0	0.0
Total Delay	291.7	2.1	33.3	6.4	19.4	4.8
Queue Length 50th (ft)	~321	0	81	54	73	0
Queue Length 95th (ft)	#583	31	#216	92	129	46
Internal Link Dist (ft)	2770			1455	742	
Turn Bay Length (ft)			270			75
Base Capacity (vph)	449	1009	414	1598	1018	1045
Starvation Cap Reductn	0	0	0	0	0	0
Spillback Cap Reductn	0	0	0	0	0	0
Storage Cap Reductn	0	0	0	0	0	0
Reduced v/c Ratio	1.57	0.26	0.70	0.25	0.28	0.38

Intersection Summary

- ~ Volume exceeds capacity, queue is theoretically infinite.
Queue shown is maximum after two cycles.
- # 95th percentile volume exceeds capacity, queue may be longer.
Queue shown is maximum after two cycles.

Queues
16: SR-76 & Old River Rd/East Vista Way

Existing + Cumulative + Project PM
07/10/2019



Lane Group	EBT	WBL	WBT	WBR	NBL	NBT	NBR	SBL	SBT
Lane Group Flow (vph)	276	155	159	927	198	2693	543	572	2056
v/c Ratio	0.75	0.78	0.76	1.28	0.83	1.16	0.60	0.76	0.75
Control Delay	49.5	107.5	105.8	174.1	109.0	121.8	17.8	79.2	38.0
Queue Delay	0.0	0.0	0.0	0.0	0.0	0.0	0.0	0.0	0.0
Total Delay	49.5	107.5	105.8	174.1	109.0	121.8	17.8	79.2	38.0
Queue Length 50th (ft)	75	203	208	~1298	245	~1456	200	353	731
Queue Length 95th (ft)	137	306	312	#1649	#389	#1719	376	467	943
Internal Link Dist (ft)	283		112			1144			2405
Turn Bay Length (ft)					835		540	385	
Base Capacity (vph)	633	332	344	722	276	2327	902	750	2748
Starvation Cap Reductn	0	0	0	0	0	0	0	0	0
Spillback Cap Reductn	0	0	0	0	0	0	0	0	0
Storage Cap Reductn	0	0	0	0	0	0	0	0	0
Reduced v/c Ratio	0.44	0.47	0.46	1.28	0.72	1.16	0.60	0.76	0.75

Intersection Summary

- ~ Volume exceeds capacity, queue is theoretically infinite.
Queue shown is maximum after two cycles.
- # 95th percentile volume exceeds capacity, queue may be longer.
Queue shown is maximum after two cycles.

Queues
17: SR-76 & N River Rd



Lane Group	EBL	EBR	NBL	NBT	SBT	SBR
Lane Group Flow (vph)	364	229	109	3520	2447	194
v/c Ratio	1.01	0.63	0.70	1.37	1.13	0.19
Control Delay	125.3	64.5	110.0	194.0	102.4	3.4
Queue Delay	0.0	0.0	0.0	0.0	0.0	0.0
Total Delay	125.3	64.5	110.0	194.0	102.4	3.4
Queue Length 50th (ft)	~487	215	140	~3145	~1926	10
Queue Length 95th (ft)	#753	335	216	#3258	#2137	49
Internal Link Dist (ft)	360			1017	712	
Turn Bay Length (ft)		70	770			685
Base Capacity (vph)	359	362	260	2783	2159	1033
Starvation Cap Reductn	0	0	0	0	0	0
Spillback Cap Reductn	0	0	0	0	0	0
Storage Cap Reductn	0	0	0	0	0	0
Reduced v/c Ratio	1.01	0.63	0.42	1.26	1.13	0.19

Intersection Summary

- ~ Volume exceeds capacity, queue is theoretically infinite.
Queue shown is maximum after two cycles.
- # 95th percentile volume exceeds capacity, queue may be longer.
Queue shown is maximum after two cycles.



Lane Group	EBL	NBL	NBT	SBT	SBR
Lane Group Flow (vph)	8	11	3962	2691	5
v/c Ratio	0.04	0.08	1.25	0.87	0.00
Control Delay	38.9	59.6	127.7	15.1	6.6
Queue Delay	0.0	0.0	0.0	0.0	0.0
Total Delay	38.9	59.6	127.7	15.1	6.6
Queue Length 50th (ft)	3	7	~326	0	0
Queue Length 95th (ft)	19	32	#2993	#1878	7
Internal Link Dist (ft)	324		613	589	
Turn Bay Length (ft)		565			445
Base Capacity (vph)	496	360	3365	3104	1389
Starvation Cap Reductn	0	0	0	0	0
Spillback Cap Reductn	0	0	0	0	0
Storage Cap Reductn	0	0	0	0	0
Reduced v/c Ratio	0.02	0.03	1.18	0.87	0.00

Intersection Summary

- ~ Volume exceeds capacity, queue is theoretically infinite.
Queue shown is maximum after two cycles.
- # 95th percentile volume exceeds capacity, queue may be longer.
Queue shown is maximum after two cycles.

Queues
19: I-15 SB Ramps & Highway 76

Existing + Cumulative + Project PM
07/10/2019



Lane Group	EBT	EBR	WBT	WBR	SBL	SBT	SBR
Lane Group Flow (vph)	1539	211	1480	209	462	440	424
v/c Ratio	1.01	0.34	1.33	0.20	1.01	0.96	0.59
Control Delay	89.0	6.7	201.0	4.3	109.8	87.0	7.7
Queue Delay	0.0	0.0	0.0	0.0	0.0	0.0	0.0
Total Delay	89.0	6.7	201.0	4.3	109.8	87.0	7.7
Queue Length 50th (ft)	~714	0	~1214	24	~615	505	0
Queue Length 95th (ft)	#808	66	#1352	61	#863	#765	104
Internal Link Dist (ft)	777		1242			680	
Turn Bay Length (ft)		600			400		
Base Capacity (vph)	1519	620	1114	1050	456	459	717
Starvation Cap Reductn	0	0	0	0	0	0	0
Spillback Cap Reductn	0	0	0	0	0	0	0
Storage Cap Reductn	0	0	0	0	0	0	0
Reduced v/c Ratio	1.01	0.34	1.33	0.20	1.01	0.96	0.59

Intersection Summary

- ~ Volume exceeds capacity, queue is theoretically infinite.
Queue shown is maximum after two cycles.
- # 95th percentile volume exceeds capacity, queue may be longer.
Queue shown is maximum after two cycles.

Queues
20: I-15 NB Ramps & Highway 76



Lane Group	EBT	EBR	WBT	WBR	NBL	NBT	NBR
Lane Group Flow (vph)	1493	646	1212	87	395	1027	1023
v/c Ratio	1.26	0.51	1.01	0.20	0.81	1.39	1.35
Control Delay	165.1	2.1	84.8	9.6	64.6	205.8	190.2
Queue Delay	0.0	0.0	0.0	0.0	0.0	0.0	0.0
Total Delay	165.1	2.1	84.8	9.6	64.6	205.8	190.2
Queue Length 50th (ft)	~974	0	~450	0	385	~1119	~1045
Queue Length 95th (ft)	#1114	39	#557	47	#553	#1413	#1326
Internal Link Dist (ft)	1242		359			627	
Turn Bay Length (ft)				545	325		
Base Capacity (vph)	1186	1277	1203	441	486	740	757
Starvation Cap Reductn	0	0	0	0	0	0	0
Spillback Cap Reductn	0	0	0	0	0	0	0
Storage Cap Reductn	0	0	0	0	0	0	0
Reduced v/c Ratio	1.26	0.51	1.01	0.20	0.81	1.39	1.35

Intersection Summary

- ~ Volume exceeds capacity, queue is theoretically infinite.
Queue shown is maximum after two cycles.
- # 95th percentile volume exceeds capacity, queue may be longer.
Queue shown is maximum after two cycles.

APPENDIX C











SELECT ZONE TRAFFIC MODEL PLOT

SANDAG
Series 12
County G.P.
2050hyb4a

TAZ 165

Select Zone Plot

Functional Classifications

-  Freeway
-  Prime
-  Major
-  Collector
-  Light Collector
-  Rural Collector
-  Local
-  Freeway Ramp
-  Local Ramp
-  Zone Connector

 Traffic Analysis Zones

Selz Volumes & Percentage

Unadjusted ADT(x1000)

Portions of this map contain information from the San Diego Association of Governments (SANDAG) Regional Information System. This product cannot be reproduced without the written permission of SANDAG.

SAN DIEGO ASSOCIATION OF GOVERNMENTS
401 B STREET, SUITE 800
SAN DIEGO, CALIFORNIA 92101 USA
(619) 699-1900
E-mail: sandag@sandag.org
Web site: www.sandag.org

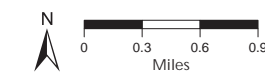

SANDAG

 servicebureau

Date: April 13, 2016

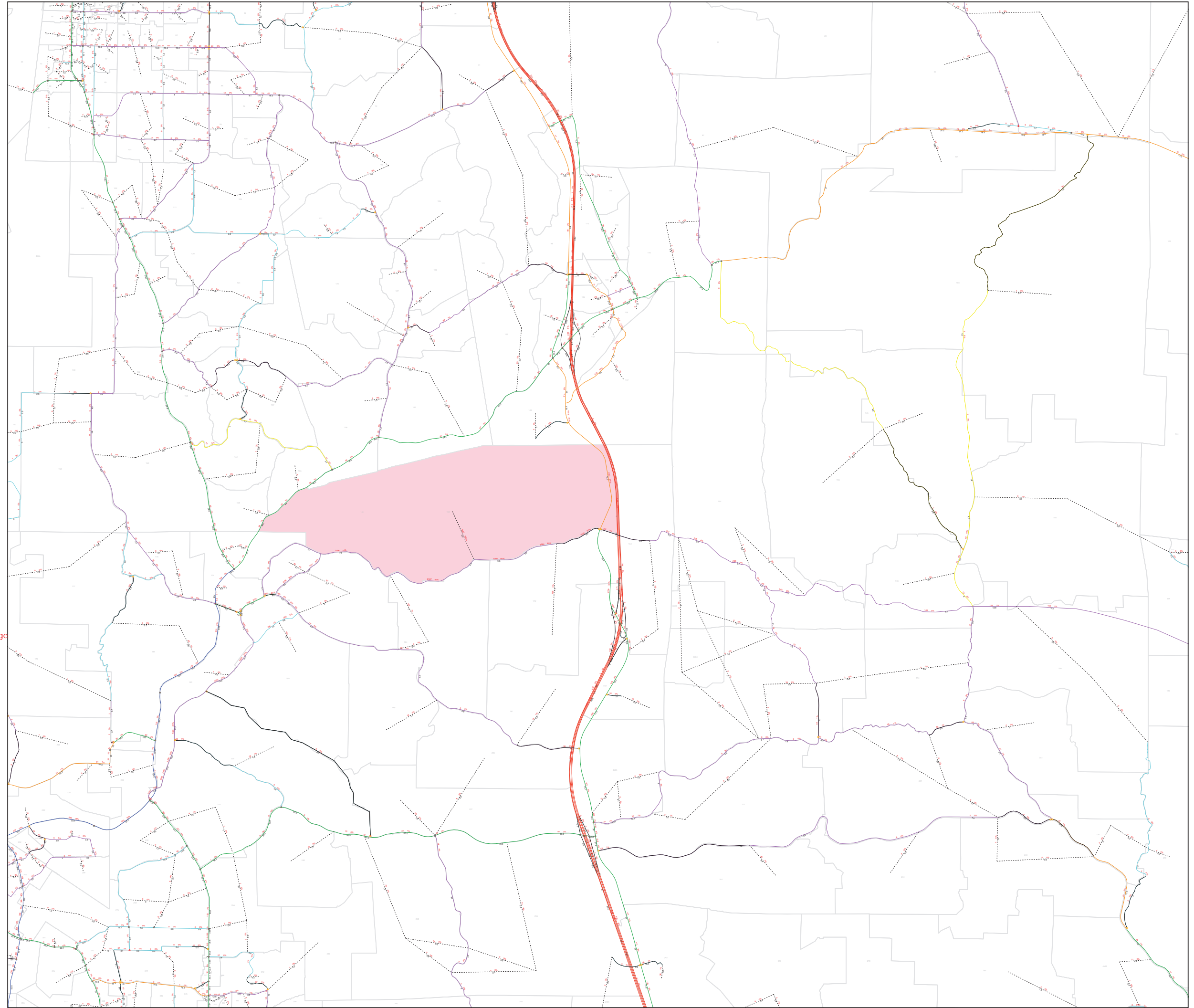

APPENDIX D

CUMULATIVE PROJECTS LIST AND MAP

Newland Sierra TIA Cumulative Projects List

**TABLE 9-1
CUMULATIVE PROJECTS TRIP GENERATION SUMMARY**

Project	Description	Location
1. Campus Park	Mixed-use development, including: 529 single-family dwelling (SFR) units, 555 multi-family dwelling (MFR) units, a town center (retail) of 62,000 square feet (sf), an office building with 150,000 sf, a sports complex of 5.2 acres, and a small neighborhood park.	Just north of SR-76, 0.25 mile east of I-15
2. Campus Park West	Mixed-use development including approximately 355 MFR units, 400,000 sf Commercial, 50,000 sf Office Professional, 347,000 sf of Light Industrial, and possible Civic Uses..	Northeast quadrant of I-15 and SR-76
3. Pala Mesa Highlands	Maximum of 130 SFR. Density 1.6 DU/acre. Lot sizes vary from 5,500 sf to 23,500 sf, two parks totaling 4.3 acres, trails, 36.5 acres of open space. SPA to allow clustering.	West of Old Highway 395 between Pala Mesa Drive and Via Belamonte
4. Tedder TM	Split lot into 13 SFR lots, ranging in size from 1.0 to 6.43 acres net.	South side of Pala Mesa Drive, west of I-15 and east of Daisy Lane
5. Hukari Subdivision	Minor residential subdivision with road improvements. 4 SFR lots plus one remainder lot (3.4 to 7.7 net acres each).	Northern terminus of Mountain View Road and West Lilac Road on west side of Bonsall
6. Fallbrook Ranch	11 SFR lots	East of Old Highway 395 and Sterling View Drive (at Mission Road), Fallbrook
7. Los Willows Inn and Spa	Add additional units to a Bed and Breakfast	532 Stewart Canyon Road
8. Reeve TPM	Minor residential subdivision. 3 SFR lots (2 acres minimum).	2987 Sumac Road, Fallbrook
9. Evans TPM	Minor subdivision into 2 residential/agricultural parcels (2.00 and 2.10 acres). Private septic system.	West side of Sage Road between Sumac Road and Pala Road, Fallbrook
10. Bridge Pac West I TPM	Minor residential subdivision. 4 SFR lots plus one remainder lot (2.04, 2.08, 2.12, 2.14 and remainder 7.08 net acres each).	3321 Sage Road, Fallbrook
11. Pala Mesa Resort	Specific Plan Amendment for modification and construction of new recreation and resort-related facilities. Addition of 186 resort rooms and wedding facility. Expansion of resort by 6 acres.	2001 Old Highway 395 at Tecalote Lane, north of SR 76 and immediately west of I-15, Fallbrook
12. Lung TPM	Minor residential subdivision. 2 SFR lots (6.7 and 4.0 acres)	Citrus Drive and Calle Canonero, Fallbrook

CONTINUED ON THE NEXT PAGE

TABLE 9-1 (CONTINUED)
CUMULATIVE PROJECTS TRIP GENERATION SUMMARY

Project	Description	Location
13. Chipman TPM	Minor residential subdivision. 4 SFR lots plus one remainder lot, ranging from 2.13 to 2.85 net acres each and remainder 4.00 net acres. Septic system.	East side of Citrus Lane between Peony Drive and Dos Ninos, Fallbrook
14. Bierman TPM	Minor residential subdivision. 4 SFR lots, ranging from 2.01 to 2.19 net acres each. Septic system.	4065 Calle Canonero, Fallbrook, south of Vern Drive and west of Lorita Lane
15. Cooke Residence	4,723 sf SFR	3974 Citrus Drive between Wilt Road and Vern Drive
16. Treister TPM	Minor residential subdivision. 4 SFR lots plus one remainder lot.	Donut-shaped parcel surrounding 401 Ranger Road, Fallbrook
17. Mission Ridge Road TPM	Minor residential subdivision. 4 SFR lots.	235 Mission Ridge Road east of I-15 off Mission Road, Fallbrook
18. Rancho Alegre TPM	Part of 116-acre subdivision (33 lots). This project consists of 20 lots in the eastern portion of property and proposes a different street alignment, grading, and lot arrangement.	West side of Ranger Road approx. 0.4 mile north of Reche Road
19. Rarick TPM	Minor residential subdivision. 4 SFR lots (ranging from 2.02 to 2.25 acres each). Septic system.	3261 Reche Road, Fallbrook
20. Fernandez TPM	Minor residential subdivision. 4 SFR lots. Minimum lot size 2 acres. 2 existing SFR on-site.	3838 Foxglove Lane, Fallbrook
21. Rabuchin TPM	Subdivision of 2 lots into 4 SFR lots. Existing SFR on site	4065 Calle Canonero, Fallbrook
22. Pala Casino	187,300 sf casino, hotel, theater.	Pala Road and Pala Mission Road
23. Rosemary's Mountain/Palomar Aggregates Quarry	Aggregate rock quarry and processing plants for concrete and asphalt. Approximately 22 million tons of rock would be mined over 20 years. Realignment of SR 76 from Project site west to I-15. Reclamation Plan to designate lower portion of site as water storage reservoir after completion of mining activities.	North side of SR 76, 1.25 miles east of I-15
24. Patapoff Minor Residential Subdivision	Subdivide property into four parcels of 4.3 acres, 4.2 acres, 9.6 acres, 8 acres, and a 33-acre parcel	Southern end of Rainbow Hills Road
25. Prominence at Pala	Subdivide the property into 30 SFR and two open space lots ranging in size from 4 to 96 acres	Pala Del Norte Road. 1/3 mile north of SR-76 and approximately two miles west of the Pala Indian Reservation

CONTINUED ON THE NEXT PAGE

**TABLE 9-1 (CONTINUED)
CUMULATIVE PROJECTS TRIP GENERATION SUMMARY**

Project	Description	Location
26. Palomar College North Education Center District Master Plan	New Community College campus to serve approximately 12,000 students, to include classroom and administration buildings, parking, open space, athletic fields, and off-site road, water and sewer improvements.	East side of I-15 between Pankey Road and Pala Mesa Heights Drive
27. Caltrans Realignment of SR-76	Realignment and widening of roadway, improvements to northbound I-15 on- and off-ramps.	From I-15 to west of Rice Canyon Road
28. San Luis Rey Municipal Water District Master Plan	Exploration of pipeline and water storage options.	SLRMWD service area and vicinity, north and south of SR-76 between I-15 and Pala Temecula Road
29. --	39 condo units	Canonita Drive and Old Hwy 395, Fallbrook
30. --	8 SFR lots	Aqueduct Road and Via Urner, Bonsall
31. --	9 SFR lots	Old Hwy 395 and Via Urner, Bonsall
32. Marquart Ranch	9 SFR lots. Includes improvements to Mesa Lilac Road, and drainage improvements.	West Lilac Road and Mesa Lilac Road, Bonsall
33. Fallbrook Oaks	19 SFR lots	Reche Road and Ranger Road, Fallbrook
34. Ridge Creek Drive	14 SFR lots	Ridge Creek east of Live Oak Park Road and Ridge Drive, Fallbrook
35. Club Estates	31 SFR lots	SR 76 east of Cole Grade Road at Pauma Valley Drive
36. Oak Tree Ranch TM	24 SFR	15560 Spring Valley Road
37. Turnbull TM	17 lots	32979 Temet Drive
38. Wexler TPM	4 lots	--
39. Shadow Run Ranch	54 SFR lots and 2 open space lots. MUP filed concurrently for Planned Residential Development that would cluster residential development on minimum 2-acre lots.	Shadow Run Ranch, SR-76 and Adams Drive, Pala
40. Diana Acres	3 lots	Adams Drive off SR-76, Pauma Valley
41. Hunter Subdivision	3 lots	15550 Adams Drive
42. Burge TPM	4 lots plus remainder	34487 Citracado Drive, Pala
43. Pauma Valley Packing Company	Packing and processing	34188 Hampton Road
44. Shadow Run Ranch/ Schoepe-Pauma TM	13 lots	15040 Adams Drive

CONTINUED ON THE NEXT PAGE

TABLE 9-1 (CONTINUED)
CUMULATIVE PROJECTS TRIP GENERATION SUMMARY

Project	Description	Location
45. Warner Ranch	732 SFR lots, 168 condo units, community park, fire station lot	Pala-Pauma
46. Pauma Casino and Hotel	400 room hotel and 171,000 s.f. casino	Approximately 11 miles east of I-15 along SR-76
47. De Jong/Pala Minor Subdivision	Minor residential subdivision. 3 SFR lots (1.03, 2.06 and 2.31 net acres each).	Canonita Drive between I-15 and Tecalote Drive
48. Crossroads Investors Minor Subdivision	Minor residential subdivision. 4 SFR lots plus one remainder lot. Existing SFR and grove on site	Ranger Road, Fallbrook
49. Chaffin/Red Mountain Ranch Subdivisions	Withdrawn TM 5217: Residential development with 29 SFR lots (2.28 to 18.33 acres) and 2 biological open space zones. TM 5225: 55 acres divided into 6 SFR lots (8.1 to 13.9 acres). TM 5227: 44.5 acres divided into 4 SFR lots (8.08 to 13.71 acres each).TM 5228: 19.1 acres divided into 2 lots (8.4 and 10.7 acres).	Rainbow Glen Road and Red Mountain Dam Road, Fallbrook
50. John Collins TPM	2 lots	Margarita in Fallbrook
51. Brannon Trust TPM Remai	4+ lots	411 Yucca Road, Fallbrook
52. Dien N Do TPM	4+ lots	405 Ranger Road
53. Tim Rosa TPM	4 lots plus remainder	2973 Los Alisos Drive
54. Leising TPM	4 lots	1246 Via Vista
55. Atteberry TPM	3 lots	1166 Sierra Bonita
56. Johnson TPM	2 lots	3035 Trelawney Lane
57. American Lotus Buddhist TPM	4 lots plus remainder lot	Reche Road at Rabbit Hill, Fallbrook
58. Chipman TPM	4 lots plus remainder	Camino Zasa, Fallbrook
59. Reche Road TM	12 SFR lots	3129 Reche Road, Bonsall
60. Palisades Estates	51 lots	3880 Dos Niños Road/Elevado Road
61. Dion TPM and time extension	2 lots	3562 Canonita Drive
62. Patricia Daniels TPM	4 lots plus remainder	3609 Canonita Road, Fallbrook
63. Cameron Subdivision	Minor residential subdivision. 3 SFR lots (2.22, 2.44 and 6.37 acres each). Septic system.	2644 Vista de Palomar, Fallbrook. North side of Vista de Palomar between Post Hill and Via Rancheros

CONTINUED ON THE NEXT PAGE

**TABLE 9-1 (CONTINUED)
CUMULATIVE PROJECTS TRIP GENERATION SUMMARY**

Project	Description	Location
64. Tesla Gray TPM	Minor residential subdivision. 4 SFR lots plus one remainder lot. Future development of 5 SFR	East end of Vista de Palomar, and north end of Old Post Road, Fallbrook
65. Aspel TPM	Minor residential subdivision. 2 SFR lots (2.09 and 5.20 acres each).	3107 Old Post Road, Fallbrook
66. James Patapoff TPM	Subdivision of 16.8 acres into 4 lots plus a remainder lot	2639 Via Alicia, Fallbrook
67. Yew Tree Spring Water Corp	3 residential lots	3573 Diego Estates Drive, Fallbrook
68. Haugh, Granger TPM	4 lots	Fallbrook
69. Brown, Lee & Karen, TPM	3 lots	3850 Gird Road
70. Pepper Drive TPM	4 residential lots	3926 Flowerwood Lane
71. Surf Properties TM	15 lots	3545 Vista Corona
72. Brook Hills TM	35 lots	4061 La Cañada Road, Fallbrook
73. Latter-Day/Via Monserate	17,000 sq. ft. church and meeting rooms	Fallbrook
74. Leeds and Strauss TM	17 SFR lots – TM time extension until 09/13/2009	North side of Olive Hill Road, near intersection with SR-76, Bonsall
75. Murray Davidson	7 lots	3956 Pala Mesa Road, Bonsall
76. Shamrock Partners TPM	3 lots	Shamrock Road, Bonsall
77. Crook TPM	5 lots	32179 Shamrock Road
78. Tabata Bonsall TPM	4 lots	5546 Mission Road
79. Berezousky TPM	Subdivision of 3.11 acre into 4 residential lots.	4040 Pala Mesa Drive, Fallbrook
80. Murray Davidson TPM	Subdivision of 1 lot into 4 SFR lots plus a remainder lot	3956 Pala Mesa Road, Fallbrook
81. Sumac TPM	4 lots	3111 Sumac Road
82. Janikowski SFR	3,200 sf SFR	9686 Pala Road (SR 76), Fallbrook, on north side of SR 76
83. Kratochvid TPM	4 lots	Old Highway 395
84. Kohl TPM	4 lots plus remainder	7641 Mount Ararat Way, Bonsall
85. Woodhead TPM	4 lots plus remainder	Mt. Ararat Way, Bonsall
86. Rockefeller TPM	2 lots	9590 Lilac Way, VC

CONTINUED ON THE NEXT PAGE

**TABLE 9-1 (CONTINUED)
CUMULATIVE PROJECTS TRIP GENERATION SUMMARY**

Project	Description	Location
87. McNulty TPM	2 lots	32171 Dos Niñas
88. Stehly Caminito Quieto TPM	4 lots	32009 Caminito Quieto at W. Lilac Road
89. Sanders TPM	4 lots plus remainder lot	West Lilac Road, 1.25 miles west of Old Highway 395
90. Pala Shopping Center	Addition of 5 commercial buildings to an existing commercial site with grocery store.	On Old Highway 395 just northwest of the intersection of I-15 and SR 76
91. Monserate TM	7 SFR	3624 Monserate Hill Road
92. Dimitri, Diffendale, Kirk TPM	4 lots	Monserate Hill Road and Monserate Place
93. Madrigal TPM	3 lots	1055 Rainbow Valley Boulevard near Old Hwy 395
94. Singh Power Plant	Power Generation facility	4 miles NE of I-15 on Pala Del Norte Road, north of SR 76
95. Gregory Landfill	Landfill site for solid waste	Approximately 3.5 miles east of I-15 on SR-76
96. Meadowood	355 single-family dwelling units, 503 multi-family dwelling units, a 10 acre neighborhood park, and an elementary school.	Just north of SR 76, 0.25 mile east of I-15
97. Bonsall - BO 18,20,22,29,32,33	61 Rural Single Family Residential - 1 unit per every 4 acres.	Bonsall - North of Camino Del Rey, west of I-15
98. Fallbrook - FB 17, 18	28 Single Family Rural Residential - splitting between SR1 and SR2 classification.	Reche Road, West of Ranger Road
99. Fallbrook - FB 21,22,23	7 Single Family Rural Residential - SR10 Class.	Northern border of county, next to river side county
100. Fallbrook - SR2	3 Single Family Rural Residential - SR10 class.	East of I-15 / Mission Road interchange
101. Fallbrook - FB19,25,26	13 Single Family Rural Residential - SR10 class.	North of Pala, East of I-15, west of Rice Canyon
102. Fallbrook - FB 21,22,23	7 Single Family Rural Residential.	Northern border of county, next to river side county
103. North County Metro - NC22	44 Single Family Rural Residential - SR1 class.	North of San Marcos Boundary, along Las Posas Road
104. North County Metro - NC37	30 Single Family Rural Residential - to SR4	West of Twin Oak Valley Road, northwest of Deer Spring road, at Calafia Road
105. North County Metro - NC3A	10 Single Family Residential - SR10	North-East of Broadway/Jesmon Dende, Access Vista Verde
106. N County Environmental Resources Recycling Facility	Recycling facility for pre-sorted, non-contaminated wood and construction debris. The project consists of 12,000 sf steel building, 100,000 gallon water tank, security, and truck scales.	25568 Mesa Rock Road, immediately east of I-15, north of SR 78

CONTINUED ON THE NEXT PAGE

TABLE 9-1 (CONTINUED)
CUMULATIVE PROJECTS TRIP GENERATION SUMMARY

Project	Description	Location
107. Valley Center - VC51	15 Single Family Rural Residential - SR-4	Corner of Courser Canyon and Lilac Road
108. Valley Center - VC57, 63, 64	238 Single Family Rural Residential - SR-2	Corner of Valley Center Road / Mactan Road
109. Valley Center - VC67	North and south of Valley center road between Miller Road and Cole Grade Road	North and south of Valley center road between Miller Road and Cole Grade Road
110. Valley Center – VC7, 11, 20A, 20B, 54, 61 ,66	261 Single Family Rural Residential - SR-2	East of I-15, south of W. Lilac Road
111. Casa de Amparo, MUP	This project is a Major Use Permit for a group residential care facility to serve up to 60 children and the child development center would have the capacity to serve 46 children.	325 Buena Creek Rd
112. Dai dang meditation center	The permit will provide for the development of the following buildings totaling 22,796 square feet: a Meditation Hall, Residence Quarters, and the Main Worship Hall	6326 Camino Del Rey
113. Dougherty pet resort/ MUP 10-027	The project also includes a proposed 1,056 square foot kennel with a rooftop grass deck and pedestrian bridge. Enough kennel for 40 dogs/cats	1412 Windsong Lane
114. Gainer, major use permit, p08-052	The project consists of construction of an approximately 10,368 square foot horse stable to accommodate up to 18 horses, construction of a 10,800 square foot covered riding arena, and improvement of the existing driveway.	6893 West Lilac Road
115. Patnode; MUP 08-036	The project proposes to construct a 4,000 square foot reception hall (not permitted in the zone), pave driveways for a shuttle to move the event attendees, and to use the existing residence as a staging area for scheduled events. Also, an unpaved parking area is proposed (not permitted).	14044 Horse Creek Trail
116. Valley Center Community Church	The project is a Major Use Permit for a new church campus on a 20.56-acre parcel. Construction will occur in four phases; at the completion of the final phase of construction, the church campus would consist of six main structures totaling approximately 65,000 square feet with associated parking, landscaping and outdoor areas.	29010 Cole Grade Road
117. Casa de Amparo MUP minor deviation p 03-	Foster Care Facility for Casa de Amparo - 4-Bldgs for a total sq. footage of 28353.	325 Buena Creek Road
118. Champagne lakes, mup, mod	Modification for the relocation of 51 RV spaces and one mobile home space to include full hookups to 20 RV spaces, a new restroom, and an area screened by landscaping for vehicle storage.	8310 Nelson Way

CONTINUED ON THE NEXT PAGE

**TABLE 9-1 (CONTINUED)
CUMULATIVE PROJECTS TRIP GENERATION SUMMARY**

Project	Description	Location
119. Crossroads church, MUP mod for pre-school	The modification proposes to install and operate relocatable pre-school classrooms. The pre-school classrooms will have a maximum of 100 students and will operate from 6am to 6:30pm Monday through Friday.	2406 N. Twin Oaks Valley Road
120. Vista Valley country club, SPA and MUP	Total increase of 12,520 sq. feet enclosed and 4,442 sq. feet un-enclosed.	2262 Gopher Canyon Road
121. Hidden meadows - Oak Woodlands rezone	The Project will contain 17.3 acres of General Commercial, 5.6 acres of Office/Professional, 7.7 acres of 10.9 DU/AC Multifamily Residential and 5.2 acres of 15.0 DU/AC Multifamily Residential.	This property is within the Northern Village Town Center of the Valley Center Community.
122. Mountain gate rezone for TM timex	Tentative Map Time Extension and Rezone to make sure that only those uses consistent with the Specific Plan are permitted. Tentative Map authorized a total of 147 single family lots.	27319, 27321, 27329 Mountain Meadow Road
123. Orchard run major subdivision (296 lot)	The project will contain 300 Single Family Residential, 5.8 acres Waste Water Treatment Plant, 1.4 Acres of Community Recreation	Valley Center Road; 13675 Old Road; 28290 Lilac Road
124. Tentative map	Approved Tentative Map for 16 dwelling units on 41.7 acres.	14357 Tyler Road
125. Alti, GPA, rez,	GPA withdrawn; however, the Tentative Map (TM 5551) proposes to subdivide 59.52 acre site into 71 lots.	14096 Sunday Drive; 27845 Valley Center Road
126. Beauvais TM	Tentative Map to subdivide 23.2 acres into 7 residential lots.	South of intersection of Bella Linda and Old Castle Road
127. Brisa del mar	The project is a Tentative Map for a residential subdivision of 206 acres into 27 x 2-acre minimum lots.	31002 Aquaduct Road; 7520, 7530, 7570, 7574, 7650 Camino Del Rey
128. Canyon villas Welk TM, rez and STP	The project is a Rezone and Tentative Map (TM 5313) to subdivide 20.89 acres into 177 time share units.	28833, 28915 Champagne Blvd; 8860 Welk View Drive
129. Charles froehlich TM	The project is a residential subdivision of two parent parcels, resulting in a total of six lots. The site is located on Double K Road within the Valley Center Community Planning Group in unincorporated San Diego County.	Sierra Roja and Double K
130. Circle p lane TM 5468rpl3	The project is a Major Subdivision of 11 proposed lots ranging in area from 1.03 to 2 gross acres on a 15.48-acre property with access via a private easement road from Mountain Meadow Road. The subject property is designated (2) Residential by the North County Metropolitan Subregional Plan	10264 Circle P Lane; 27446 Mountain Meadow Road
131. Dabbs tentative map	This is a request for a tentative map on 38.4 acres (gross acres). The subdivision proposes 9 lots. Each proposed lot will be 4 acres in size (net acres).	32006 Aquaduct Road

CONTINUED ON THE NEXT PAGE

**TABLE 9-1 (CONTINUED)
CUMULATIVE PROJECTS TRIP GENERATION SUMMARY**

Project	Description	Location
132. Foxenwood prd TM 4836 & STP 89-041	Tentative Map to subdivide 45.2 acres into 17 dwelling units.	Mirar De Valle
133. Golf green estates/s/site plan	116 Lot subdivisions of 6,000 square foot parcels.	Old River Road and Camino Del Rey
134. Kawano subdivision	Tentative Map to subdivide 10.51 into 8 residential lots.	1050 Ora Avo Drive
135. McIntyre TPM 5014	Lilac Mountain Ranch: 22-lot/108-ac	11278 Lilac Vista Drive;
136. Oak glen	The project proposes major subdivision of 20.01 acres. The subdivision proposes nine single family residences on 2 acre minimum lots. 9 Single Family Residential.	14099 West Oak Glen Road
137. Orchard Vista, TM, rez	Withdrawn	13278 Orchard Vista Road
138. Pauma Ranches	The project is a Tentative Map to subdivide 100 acres into 22 residential lots, with each lot no less than 4 acres in size.	30434 Montrachet Street;
139. Rabbit run, TM, 10 lots	The project is a major subdivision of 17.70 gross acres into 7 lots ranging in size from 2.03 to 4.02 gross acres.	29222, 29270 Duffwood Lane
140. West Lilac Farms I & II	Approved Tentative Map for 28 single family lots on 92.8 acres.	31817 Via Ararat Drive; 32542 Aquaduct Road
141. Boyer tpm 20794	Approved Tentative Parcel Map for 3 lots on 3 acres.	
142. Cunningham , TPM, 2 lots	The project proposes to create two legal lots from Assessor Parcel Numbers 172-140-62 and 64. Parcel 1 is 7.40 net acres and Parcel 2 is 17.6 net acres.	1221 Tarek Trail
143. Fitzpatrick TPM	The project is a minor subdivision of a 10.8-acre parcel currently being used for agriculture (avocado grove). The project proposes to develop four residential lots ranging in size from 2.3 to 3.1 acre.	Tomsyl Road
144. Gangavalli, TPM, 2 lots	The project proposes to divide 5.05 net acres into 2 parcels measuring 2.51 acres gross (2.29 acres net), and 2.51 acres gross (2.45 acres net).	10418 King Sanday Lane
145. Goodnight ranchos, TPM, 2 lots	The project proposes to divide 5.0 acres into 2 parcels measuring 2.45 acres net each. The proposed parcels will have frontage upon Circle R Lane.	30359 Circle R Lane
146. Harlow TPM	3 Lot Subdivision	12542 Betsworth Road
147. Hefner/brown 4 lot and remainder TPM: TP	Subdivide a +/-57.9 acre parcel into four lots plus a remainder (lots range from 7.4 to 13.1 net acres).	31460 Aquaduct Road
148. Kim tentative parcel map	4 lots TPM w/ Remainder Parcel The project is a tentative parcel map application to subdivide a 46.72 acre parcel into 4 lots plus a remainder lot, ranging in area from 7.4 acres to 12.2 acres, for residential land use.	29640 Pamoosa Lane

CONTINUED ON THE NEXT PAGE

**TABLE 9-1 (CONTINUED)
CUMULATIVE PROJECTS TRIP GENERATION SUMMARY**

Project	Description	Location
149. Kirkorowicz, TPM,	The project proposes a two lot subdivision for the creation of two single-family residences and associated driveways and septic.	Fairview Road
150. Matheson, TPM 21173	12.83 acres into 2 residential lots of 4.013 and 8.259 net acres.	1202 Rancho Luiseno Road
151. McBride, TPM, 2 lots	2-lot residential subdivision	29945 Spearhead Trail
152. McNally rd parcel map	The project proposes to divide 78.3 acres into 4 parcels and a remainder measuring 8.3 acres net, 4.2 acres net, 4.0 acres net, 4.0 acres net and 57.8 acres net, respectively.	McNally Road; Lilac Road
153. Moddelmoa TPM	Tentative Parcel Map to subdivide 21.1 acres into 4 parcels and a remainder.	30455 and 30463 Roadrunner Ridge South
154. Mustafa TPM	Tentative Parcel Map to subdivide 16.4 acres into 4 parcels and a remainder.	9770 Circle R Road
155. Nichols Whitman, TPM	TPM 4 Lots	10015 W Lilac Road
156. Rimsa TPM 2 lots	2 Single Family Residential lots	235 West Camino Calafia
157. Rios, TPM 21143	The project is a minor subdivision to create 2 parcels	12902 Mirar de Valle Road
158. Robinson, TPM, 4 lots	4 Single Family Residential lots	10127 Circle R Drive
159. Sage Meadow TPM	2 Single Family Residential lots	13510 Sage Meadow Lane
160. Sanders, TPM	Tentative Parcel Map: Standard 4 lots plus a reminder lot	6993 W Lilac Road
161. Souris, TPM, 4 lots	Divide 38.8 net acres into 4 parcels ranging in size from 4.01 to 21.47 net acres. One existing single-family residence and guesthouse resides on Parcel 3 and will remain	14174 Sun Rocks Drive
162. Tran TPM	4 Single Family Residential lots	29623 Valley of the King Road
163. Turner, TPM	4 Single Family Residential lots	29133 Sandy Hill Drive
164. Weber, TPM 21128	4 Single Family Residential lots	3458 Royal Road
165. Wild, TPM 21170	4 Single Family Residential lots	1560 Wild Acres Road
166. Yuan, minor subdivision + remainder, TPM	The project is a Tentative Map to subdivide 89.88 acres into four parcels plus a remainder parcel.	Old River Road and Dentro de Lomas
167. Pfaff, TPM, 3 lots	Tentative parcel map to divide a 7.79 acre parcel into three residential lots of 2.5, 2.1 and 2.7 net acres (Parcels 1, 2 and 3 respectively). The site contains an existing single-family residence on proposed Parcel 1 that would be retained.	32010 Caminito Quieto
168. Kohne Residence, rez	Withdrawn	Calle Oro Verde

CONTINUED ON THE NEXT PAGE

**TABLE 9-1 (CONTINUED)
CUMULATIVE PROJECTS TRIP GENERATION SUMMARY**

Project	Description	Location
169. Castle Creek Condominiums, GPA, SPA, TPM	The project is a General Plan Amendment, Specific Plan Amendment, and Tentative Map to change the existing Land Use Designations to (21) Specific Plan Area in order to increase the density from 1.29 to 1.37 to allow a Tentative Map to subdivide the site into 63 dwelling units.	8790 Old Castle Road
170. Lilac Hills Ranch	The project consists of a mix of residential, commercial, and institutional uses. 61,500 sf of specialty retail, 28,500 sf of office uses, 50-room country inn, 903 single-family detached homes, 375 multi-family homes, 468 age-restricted single-family homes, and civic facilities including fire station, parks, recreational center and amenities.	Generally bounded by SR-76 to the north, Valley Center to the east, Escondido to the south, and I-15 and Old Highway 395 to the west.
171. Pacific Industrial No. 1	22,160 sf industrial building	Pacific Street, north of Grand Ave.
172. Pacific Commercial	31,776 square foot commercial center	Northeast corner of Grand Ave. and Pacific St.
173. Main Street Plaza	Mixed-use development in Creek District Specific Plan (see #175) - 66,450 sf commercial, 428 apartments, 53,700 sf multi-use & 836 parking spaces.	1167 W. San Marcos Blvd
174. San Marcos Creek Specific Plan	Mixed-use development consisting of 1,265,000 sf of retail, 589,000 sf of office and 2,300 dwelling units.	Generally between Discovery Street and San Marcos Blvd.
175. Richmar Specific Plan	Mixed-use development. Incorporated as part of the general plan update.	Generally south of Richmar Avenue to that area north of the San Marcos Elementary School
176. Palomar Station	The 44,000 sf retail component of the mixed-use project consists of ground floor retail on the south side of Armorlite Drive facing Las Posas Road, and ground floor retail at the northwest and northeast corners of the north side of Armorlite and at the rear of the northerly phase adjacent to the Sprinter transit access. There is also a freestanding retail pad adjacent to Las Posas which is being marketed.	South of Mission Road, east of Las Posas Road, north & south of Armorlite Drive
177. Palomar Station	Mixed-use development consisting of 370 condominiums, 44,000 sf of commercial, 5,400 sf live/work, 5,000 sf restaurant/food court uses, and 70,000 sf of recreation	South of Mission Road, east of Las Posas Road, north & south of Armorlite Drive
178. East Gate	Mixed-use development of 42 units Multi-Family Affordable Housing and 11,285 sf of Retail/Commercial	NW corner of Grand Avenue and future Creekside Drive
179. The Promenade @ Creekside	Mixed-use development in Creek District Specific Plan - two and three-story, 98 affordable housing units and 26,491 sf Commercial/Retail/Recreation (see #175)	South side of future Creekside Drive, between Bent Avenue and Grand Avenue

CONTINUED ON THE NEXT PAGE

subdivision, TM 5184, that was approved on June 10, 2004 and expired on June 10, 2007. The project now proposes to subdivide 24.62 gross acres into 9 single-family residential lots ranging in size from 2.02 to 2.90 net acres.

**TABLE 6.1
CUMULATIVE PROJECTS**

Map Key #	Project	Description	Project Reference Numbers	Area (acres)	Location
1	Campus Park	Mixed-use development, including: 529 single-family dwelling (SFR) units, 555 multi-family dwelling (MFR) units, a town center (retail) of 62,000 square feet (sf), an office building with 150,000 sf, a sports complex of 5.2 acres, and a small neighborhood park.	TM 5338 GPA 03-004	417	Just north of SR-76, 0.25 mile east of I-15
2	Campus Park West	Mixed-use development including approximately 355 MFR units, 400,000 sf Commercial, 50,000 sf Office Professional, 347,000 sf of Light Industrial, and possible Civic Uses..	TM 5424, S 05-014, SPA 05-001 GPA 05-003 REZ 05-005	118.5	Northeast quadrant of I-15 and SR-76
3	Pala Mesa Highlands	Maximum of 130 SFR. Density 1.6 DU/acre. Lot sizes vary from 5,500 sf to 23,500 sf, two parks totaling 4.3 acres, trails, 36.5 acres of open space. SPA to allow clustering.	TM 5187 RPL ¹¹ SPA 99-005 MUP 99-020 REZ 99-020 MUP/REZ 04-024	84.6	West of Old Highway 395 between Pala Mesa Drive and Via Belamonte
4	Tedder TM	Split lot into 13 SFR lots, ranging in size from 1.0 to 6.43 acres net.	TM 4729 RPL ³ TE	29.5	South side of Pala Mesa Drive, west of I-15 and east of Daisy Lane
5	Hukari subdivision	Minor residential subdivision with road improvements. 4 SFR lots plus one remainder lot (3.4 to 7.7 net acres each).	TPM 20830	30	Northern terminus of Mountain View Road and West Lilac Road on west side of Bonsall
6	Fallbrook Ranch	11 SFR lots	TM 5532 S 07-012	--	East of Old Highway 395 and Sterling View Drive (at Mission Road), Fallbrook
7	Los Willows Inn and Spa	Add additional units to a Bed and Breakfast	MUP 03-127	--	532 Stewart Canyon Road
8	Reeve TPM	Minor residential subdivision. 3 SFR lots (2 acres minimum).	TPM 20411	8.8	2987 Sumac Road, Fallbrook

**TABLE 6.1
CUMULATIVE PROJECTS**

Map Key #	Project	Description	Project Reference Numbers	Area (acres)	Location
9	Evans TPM	Minor subdivision into 2 residential/agricultural parcels (2.00 and 2.10 acres). Private septic system.	TPM 20491	4.10	West side of Sage Road between Sumac Road and Pala Road, Fallbrook
10	Bridge Pac West I TPM	Minor residential subdivision. 4 SFR lots plus one remainder lot (2.04, 2.08, 2.12, 2.14 and remainder 7.08 net acres each).	TPM 20841	15.90	3321 Sage Road, Fallbrook
11	Pala Mesa Resort	Specific Plan Amendment for modification and construction of new recreation and resort-related facilities. Addition of 186 resort rooms and wedding facility. Expansion of resort by 6 acres.	SPA 03-005 R 00-000 MUP 00-000 P 74-120W ¹ P 74-121M ¹⁰ ; MUP 03-006; MUP 04-005	181.2	2001 Old Highway 395 at Tecalote Lane, north of SR 76 and immediately west of I-15, Fallbrook
12	Lung TPM	Minor residential subdivision. 2 SFR lots (6.7 and 4.0 acres)	TPM 20431 S 98-006	10.7	Citrus Drive and Calle Canonero, Fallbrook
13	Chipman TPM	Minor residential subdivision. 4 SFR lots plus one remainder lot, ranging from 2.13 to 2.85 net acres each and remainder 4.00 net acres. Septic system.	TPM 20440	13.54	East side of Citrus Lane between Peony Drive and Dos Ninos, Fallbrook
14	Bierman TPM	Minor residential subdivision. 4 SFR lots, ranging from 2.01 to 2.19 net acres each. Septic system.	TPM 20484	9.91	4065 Calle Canonero, Fallbrook, south of Vern Drive and west of Lorita Lane
15	Cooke Residence	4,723 s.f. SFR	S 04-026	N/A	3974 Citrus Drive between Wilt Road and Vern Drive
16	Treister TPM	Minor residential subdivision. 4 SFR lots plus one remainder lot.	TPM 20581	21.81	Donut-shaped parcel surrounding 401 Ranger Road, Fallbrook
17	Mission Ridge Road TPM	Minor residential subdivision. 4 SFR lots.	TPM 20793 03-02-068	19.55	235 Mission Ridge Road east of I-15 off Mission Road, Fallbrook
18	Rancho Alegre TPM	Part of 116-acre subdivision (33 lots). This project consists of 20 lots in the eastern portion of property and proposes a different street alignment, grading, and lot arrangement.	TM 5413	70	West side of Ranger Road approx. 0.4 mile north of Reche Road

**TABLE 6.1
CUMULATIVE PROJECTS**

Map Key #	Project	Description	Project Reference Numbers	Area (acres)	Location
19	Rarick TPM	Minor residential subdivision. 4 SFR lots (ranging from 2.02 to 2.25 acres each). Septic system.	TPM 20853	8.77	3261 Reche Road, Fallbrook
20	Fernandez TPM	Minor residential subdivision. 4 SFR lots. Minimum lot size 2 acres. 2 existing SFR on-site.	TPM 20936	10.4	3838 Foxglove Lane, Fallbrook
21	Rabuchin TPM	Subdivision of 2 lots into 4 SFR lots. Existing SFR on site	TPM 20944	9.91	4065 Calle Canonero, Fallbrook
22	Pala Casino	187,300 s.f. casino, hotel, theater.	NA	TBD	Pala Road and Pala Mission Road
23	Rosemary's Mountain/Palomar Aggregates Quarry	Aggregate rock quarry and processing plants for concrete and asphalt. Approximately 22 million tons of rock would be mined over 20 years. Realignment of SR 76 from Project site west to I-15. Reclamation Plan to designate lower portion of site as water storage reservoir after completion of mining activities.	MUP 87-021 RPL ² REZ P87-001 RPL ²	96.4	North side of SR 76, 1.25 miles east of I-15
24	Patapoff Minor Residential Subdivision	Subdivide property into four parcels of 4.3 acres, 4.2 acres, 9.6 acres, 8 acres, and a 33-acre parcel	TPM 20542	59.1	Southern end of Rainbow Hills Road
25	Prominence at Pala	Subdivide the property into 30 SFR and two open space lots ranging in size from 4 to 96 acres	TM 5321	346.6	Pala Del Norte Road. 1/3 mile north of SR-76 and approximately two miles west of the Pala Indian Reservation
26	Palomar College North Education Center District Master Plan	New Community College campus to serve approximately 12,000 students, to include classroom and administration buildings, parking, open space, athletic fields, and off-site road, water and sewer improvements.	NA	85	East side of I-15 between Pankey Road and Pala Mesa Heights Drive
27	Caltrans Realignment of SR-76	Realignment and widening of roadway, improvements to northbound I-15 on- and off-ramps.	NA	NA	From I-15 to west of Rice Canyon Road

**TABLE 6.1
CUMULATIVE PROJECTS**

Map Key #	Project	Description	Project Reference Numbers	Area (acres)	Location
28	San Luis Rey Municipal Water District (SLRMWD) Water, Wastewater and Recycled Water Master Plan	Exploration of pipeline and water storage options.	NA	Over 3,000	SLRMWD service area and vicinity, north and south of SR-76 between I-15 and Pala Temecula Road
29	--	39 condo units	TM 5231	30.48	Canonita Drive and Old Hwy 395, Fallbrook
30	--	8 SFR lots	TM 5276	12.8	Aqueduct Road and Via Urner, Bonsall
31	--	9 SFR lots	TM 5346	38.4	Old Hwy 395 and Via Urner, Bonsall
32	Marquart Ranch	9 SFR lots. Includes improvements to Mesa Lilac Road, and drainage improvements.	TM 5410	44.2	West Lilac Road and Mesa Lilac Road, Bonsall
33	Fallbrook Oaks	19 SFR lots	TM 5449	26	Reche Road and Ranger Road, Fallbrook
34	Ridge Creek Drive	14 SFR lots	TM 5469	30.4	Ridge Creek east of Live Oak Park Road and Ridge Drive, Fallbrook
35	Club Estates	31 SFR lots	TM 5499	48.3	SR 76 east of Cole Grade Road at Pauma Valley Drive
36	Oak Tree Ranch TM	24 SFR	TM 5540; MUP 07-007	9.95	15560 Spring Valley Road
37	Turnbull TM	17 lots	TM 5545	22.9	32979 Temet Drive
38	Wexler TPM	4 lots	TPM 20913	2.54	--
39	Shadow Run Ranch	54 SFR lots and 2 open space lots. MUP filed concurrently for Planned Residential Development that would cluster residential development on minimum 2-acre lots.	TM 5223 MUP 00-030	263	Shadow Run Ranch, SR-76 and Adams Drive, Pala
40	Diana Acres	3 lots	TPM 20896	--	Adams Drive off SR-76, Pauma Valley
41	Hunter Subdivision	3 lots	TPM 20804	7.5	15550 Adams Drive

**TABLE 6.1
CUMULATIVE PROJECTS**

Map Key #	Project	Description	Project Reference Numbers	Area (acres)	Location
42	Burge TPM	4 lots plus remainder	TPM 20538	12.58	34487 Citracado Drive, Pala
43	Pauma Valley Packing Company	Packing and processing	MUP 99-001	4.14	34188 Hampton Road
44	Shadow Run Ranch/ Schoepe-Pauma TM	13 lots	TM 5223; MUP 00-030	263.17	15040 Adams Drive
45	Warner Ranch	732 SFR lots, 168 condo units, community park, fire station lot	TM 5508	513	Pala-Pauma
46	Pauma Casino and Hotel	400 room hotel and 171,000 s.f. casino	CASINO	--	Approximately 11 miles east of I-15 along SR-76
47	De Jong/Pala Minor Subdivision	Minor residential subdivision. 3 SFR lots (1.03, 2.06 and 2.31 net acres each).	TPM 20451	5.62	Canonita Drive between I-15 and Tecalote Drive
48	Crossroads Investors Minor Subdivision	Minor residential subdivision. 4 SFR lots plus one remainder lot. Existing SFR and grove on site	TPM 20800	15.5	Ranger Road, Fallbrook
49	Chaffin/Red Mountain Ranch Subdivisions	Withdrawn TM 5217: Residential development with 29 SFR lots (2.28 to 18.33 acres) and 2 biological open space zones. TM 5225: 55 acres divided into 6 SFR lots (8.1 to 13.9 acres). TM 5227: 44.5 acres divided into 4 SFR lots (8.08 to 13.71 acres each). TM 5228: 19.1 acres divided into 2 lots (8.4 and 10.7 acres).	TM 5217/5225/5227/5228 MUP 00-027	455.9	Rainbow Glen Road and Red Mountain Dam Road, Fallbrook
50	John Collins TPM	2 lots	TPM 20505	8.29	Margarita in Fallbrook
51	Brannon Trust TPM Remai	4+ lots	TPM 21085	--	411 Yucca Road, Fallbrook
52	Dien N Do TPM	4+ lots	TPM 20976	--	405 Ranger Road
53	Tim Rosa TPM	4 lots plus remainder	TPM 20373	13	2973 Los Alisos Drive
54	Leising TPM	4 lots	TPM 20427	10.83	1246 Via Vista
55	Atteberry TPM	3 lots	TPM 20434	9	1166 Sierra Bonita

**TABLE 6.1
CUMULATIVE PROJECTS**

Map Key #	Project	Description	Project Reference Numbers	Area (acres)	Location
56	Johnson TPM	2 lots	TPM 20980	--	3035 Trelawney Lane
57	Chipman TPM	4 lots plus remainder	TPM 20381	24.5	Camino Zasa, Fallbrook
58	American Lotus Bhuddist Association TPM	4 lots plus remainder lot	TPM 21047	--	Reche Road at Rabbit Hill, Fallbrook
59	Reche Road TM	12 SFR lots	TM 5547	33.5	3129 Reche Road, Bonsall
60	Palisades Estates	51 lots	TM 5158; RPL3	408.4	3880 Dos Niños Road/Elevado Road
61	Dion TPM and time extension	2 lots	TPM 19742	7.5	3562 Canonita Drive
62	Patricia Daniels TPM	4 lots plus remainder	TPM 20476	13.2	3609 Canonita Road, Fallbrook
63	Cameron Subdivision	Minor residential subdivision. 3 SFR lots (2.22, 2.44 and 6.37 acres each). Septic system.	TPM 20443	11.31	2644 Vista de Palomar, Fallbrook. North side of Vista de Palomar between Post Hill and Via Rancheros
64	Tesla Gray TPM	Minor residential subdivision. 4 SFR lots plus one remainder lot. Future development of 5 SFR	TPM 20473	28.91	East end of Vista de Palomar, and north end of Old Post Road, Fallbrook
65	Aspel TPM	Minor residential subdivision. 2 SFR lots (2.09 and 5.20 acres each).	TPM 20592	7.32	3107 Old Post Road, Fallbrook
66	James Patapoff TPM	Subdivision of 16.8 acres into 4 lots plus a remainder lot	TPM 20317	16.8	2639 Via Alicia, Fallbrook
67	Yew Tree Spring Water Corporation	3 residential lots	TPM 20503	7.48	3573 Diego Estates Drive, Fallbrook
68	Haugh, Granger TPM	4 lots	TPM 20610	12.94	Fallbrook
69	Brown, Lee & Karen, TPM	3 lots	TPM 20614; RPL1	6.46	3850 Gird Road
70	Pepper Drive TPM	4 residential lots	TPM 20648	1.39	3926 Flowerwood Lane
71	Surf Properties TM	15 lots	TM 4971	46.89	3545 Vista Corona

**TABLE 6.1
CUMULATIVE PROJECTS**

Map Key #	Project	Description	Project Reference Numbers	Area (acres)	Location
72	Brook Hills TM	35 lots	TM 4908	96.71	4061 La Cañada Road, Fallbrook
73	Latter-Day Saints/Via Monserate	17,000 sq. ft. church and meeting rooms	MUP 02-011	7.96	Fallbrook
74	Leeds and Strausss TM	17 SFR lots – TM time extension until 09/13/2009	TM 4976; RPL4	45.76	North side of Olive Hill Road, near intersection with SR-76, Bonsall
75	Murray Davidson	7 lots	TM 5398	4.28	3956 Pala Mesa Road, Bonsall
76	Shamrock Partners TPM	3 lots	TPM 20173	10	Shamrock Road, Bonsall
77	Crook TPM	5 lots	TPM 20851	--	32179 Shamrock Road
78	Tabata Bonsall TPM RPL1	4 lots	TPM 20729	33.75	5546 Mission Road
79	Berezousky TPM (311 Same as one in original latch)	Subdivision of 3.11 acre into 4 residential lots. Existing SFR on site	TPM 20874	3.11	4040 Pala Mesa Drive, Fallbrook
80	Murray Davidson TPM	Subdivision of 1 lot into 4 SFR lots plus a remainder lot	TPM 20932	--	3956 Pala Mesa Road, Fallbrook
81	Sumac TPM	4 lots	TPM 21076	--	3111 Sumac Road
82	Janikowski SFR	3,200 s.f. SFR	S 03-024	5.12	9686 Pala Road (SR 76), Fallbrook, on north side of SR 76
83	Kratochvid TPM; expired map	4 lots	TPM 19827	12.3	Old Highway 395
84	Kohl TPM	4 lots plus remainder	TPM 20319	9.71	7641 Mount Ararat Way, Bonsall
85	Woodhead TPM	4 lots plus remainder	TPM 20541	12.54	Mt. Ararat Way, Bonsall
86	Rockefeller TPM	2 lots	TPM 20596	5	9590 Lilac Way, VC
87	McNulty TPM	2 lots	TPM 20763	5.19	32171 Dos Niñas
88	Stehly Caminito Quieto TPM	4 lots	TPM 20799	11.69	32009 Caminito Quieto at West Lilac Road

**TABLE 6.1
CUMULATIVE PROJECTS**

Map Key #	Project	Description	Project Reference Numbers	Area (acres)	Location
89	Sanders TPM	4 lots plus remainder lot	TPM 20845	--	West Lilac Road, 1.25 miles west of Old Highway 395
90	Pala Shopping Center	Addition of 5 commercial buildings to an existing commercial site with grocery store.	S 02-061	3.88	On Old Highway 395 just northwest of the intersection of I-15 and SR 76
91	Monserate TM	7 SFR	TM 5489	24.6	3624 Monserate Hill Road
92	Dimitri, Diffendale, and Kirk TPM	4 lots	TPM 21075	--	Monserate Hill Road and Monserate Place
93	Madrigal TPM	3 lots	TPM 20994	--	1055 Rainbow Valley Boulevard near Old Hwy 395
94	Singh Power Plant	Power Generation facility	MUP 07-009	8.5	4 miles NE of I-15 on Pala Del Norte Road, north of SR 76
95	Gregory Landfill	Landfill site for solid waste	37-AA-0032	1,770	Approximately 3.5 miles east of I-15 on SR-76
96	Meadowood	355 single-family dwelling units, 503 multi-family dwelling units, a 10 acre neighborhood park, and an elementary school.	TM 5354 & GPA 04-02	--	Just north of SR-76, 0.25 mile east of I-15
97	Bonsall - BO 18,20,22,29,32, 33	61 Rural Single Family Residential - 1 unit per every 4 acres.	Bonsall - BO 18,20,22,29,32,3 3	--	Bonsall - North of Camino Del Rey, west of I-15
98	Fallbrook - FB 17, 18	28 Single Family Rural Residential - splitting between SR1 and SR2 classification.	Fallbrook - FB 17, 18	--	Reche Road, West of Ranger Road
99	Fallbrook - FB 21,22,23	7 Single Family Rural Residential - SR10 Class.	Fallbrook - FB 21,22,23	--	Northern border of county, next to river side county
100	Fallbrook - SR2	3 Single Family Rural Residential - SR10 class.	Fallbrook - SR2	--	East of I-15 / Mission Road interchange
101	Fallbrook - FB19,25,26	13 Single Family Rural Residential - SR10 class.	Fallbrook - FB19,25,26	--	North of Pala, East of I-15, west of Rice Canyon
102	Fallbrook - FB 21,22,23	7 Single Family Rural Residential.	Fallbrook - FB 21,22,23	--	Northern border of county, next to river side county

**TABLE 6.1
CUMULATIVE PROJECTS**

Map Key #	Project	Description	Project Reference Numbers	Area (acres)	Location
103	North County Metro - NC22	44 Single Family Rural Residential - SR1 class.	North County Metro - NC22	--	North of San Marcos Boundary, along Las Posas Road
104	North County Metro - NC37	30 Single Family Rural Residential - to SR4	North County Metro - NC37	--	West of Twin Oak Valley Road, northwest of Deer Spring road, at Calafia Road
105	North County Metro - NC3A	10 Single Family Residential - SR10	North County Metro - NC3A	--	North-East of Broadway/Jesmon Dende, Access Vista Verde
106	North County Metro - NC42/ Sierra (former Merriam Mountains)	The Sierra (former Merriam Mountains) Development project is expected to request the construction of 2,100 residential units and a small amount of commercial development.	North County Metro - NC42/ Sierra (former Merriam Mountains)	--	North of Deer Spring, West of I-15, South of Gopher Canyon
107	Valley Center - VC51	15 Single Family Rural Residential - SR-4	Valley Center - VC51	--	Corner of Courser Canyon and Lilac Road
108	Valley Center - VC57, 63, 64	238 Single Family Rural Residential - SR-2	Valley Center - VC57, 63, 64	--	Corner of Valley Center Road / Mactan Road
109	Valley Center - VC67	North and south of Valley center road between Miller Road and Cole Grade Road	Valley Center - VC67	--	North and south of Valley center road between Miller Road and Cole Grade Road
110	Valley Center - VC7, 11, 20A, 20B, 54, 61, 66	261 Single Family Rural Residential - SR-2	Valley Center - VC7, 11, 20A, 20B, 54, 61, 66	--	East of I-15, south of W. Lilac Road
111	Casa de amparo, mup	This project is a Major Use Permit for a group residential care facility to serve up to 60 children and the child development center would have the capacity to serve 46 children.	04-14603	--	325 Buena Creek Rd
112	Dai dang meditation center	The permit will provide for the development of the following buildings totaling 22,796 square feet: a Meditation Hall, Residence Quarters, and the Main Worship Hall	04-11468	--	6326 Camino Del Rey

**TABLE 6.1
CUMULATIVE PROJECTS**

Map Key #	Project	Description	Project Reference Numbers	Area (acres)	Location
113	Dougherty pet resort/mup 10-027	The project also includes a proposed 1,056 square foot kennel with a rooftop grass deck and pedestrian bridge. Enough kennel for 40 dogs/cats	07-0081283	--	1412 Windsong Lane
114	Gainer, major use permit, p08-052	The project consists of construction of an approximately 10,368 square foot horse stable to accommodate up to 18 horses, construction of a 10,800 square foot covered riding arena, and improvement of the existing driveway.	08-0096048	--	6893 West Lilac Road
115	Patnode ; mup 08-036	The project proposes to construct a 4,000 square foot reception hall (not permitted in the zone), pave driveways for a shuttle to move the event attendees, and to use the existing residence as a staging area for scheduled events. Also, an unpaved parking area is proposed (not permitted).	08-0100394	--	14044 Horse Creek Trail
116	Valley center comm church	The project is a Major Use Permit for a new church campus on a 20.56-acre parcel. Construction will occur in four phases: at the completion of the final phase of construction, the church campus would consist of six main structures totaling approximately 65,000 square feet with associated parking, landscaping and outdoor areas.	04-13720	20.56	29010 Cole Grade Road
117	Casa de amparo mup minor deviation p 03-	Foster Care Facility for Casa de Amparo - 4-Bldgs for a total sq footage of 28353.	10-0121634	--	325 Buena Creek Road
118	Champagne lakes, mup, mod	Modification for the relocation of 51 RV spaces and one mobile home space to include full hookups to 20 RV spaces, a new restroom, and an area screened by landscaping for vehicle storage.	06-0055819	--	8310 Nelson Way

**TABLE 6.1
CUMULATIVE PROJECTS**

Map Key #	Project	Description	Project Reference Numbers	Area (acres)	Location
119	Crossroads church, mup mod for pre-school	The modification proposes to install and operate relocatable pre-school classrooms. The pre-school classrooms will have a maximum of 100 students and will operate from 6am to 6:30pm Monday through Friday.	08-0094758	--	2406 N. Twin Oaks Valley Road
120	Moody creek farms llc, mup mod; p79-134w	The project will consist of expansion of the footprint of the previously approved Major Use Permit to include all of the stables; barns; riding rings and arenas; ¾ mile horse training track; ranch manager's residence; farm employee housing; and accessory structures associated with the Equestrian Facility.	09-0107476	--	30185 and 30321 Camino De Los Caballos; 31257 Via Maria Elena
121	Vista valley country club, spa and mup m	Total increase of 12,520 sq. feet enclosed and 4,442 sq. feet un-enclosed.	08-0100054	--	2262 Gopher Canyon Road
122	Hidden meadows - oak woodlands rezone	The Project will contain 17.3 acres of General Commercial, 5.6 acres of Office/Professional, 7.7 acres of 10.9 DU/AC Multifamily Residential and 5.2 acres of 15.0 DU/AC Multifamily Residential.	04-16685	17.3	This property is within the Northern Village Town Center of the Valley Center Community.
123	Mountain gate rezone for tm timex	Tentative Map Time Extension and Rezone to make sure that only those uses consistent with the Specific Plan are permitted. Tentative Map authorized a total of 147 single family lots.	04-15133	--	27319, 27321, 27329 Mountain Meadow Road
124	Orchard run major subdivision (296 lot)	The project will contain 300 Single Family Residential, 5.8 acres Waste Water Treatment Plant, 1.4 Acres of Community Recreation	08-0092691	--	Valley Center Road; 13675 Old Road; 28290 Lilac Road
125	Tentative map	Approved Tentative Map for 16 dwelling units on 41.7 acres.	04-20072	41.7	14357 Tyler Road
126	Alti, gpa, rez,	GPA withdrawn; however, the Tentative Map (TM 5551) proposes to subdivide 59.52 acre site into 71 lots.	06-0064250	59.52	14096 Sunday Drive; 27845 Valley Center Road
127	Beauvais tm	Tentative Map to subdivide 23.2 acres into 7 residential lots.	04-13906	23.2	South of intersection of Bella Linda and Old Castle Road

**TABLE 6.1
CUMULATIVE PROJECTS**

Map Key #	Project	Description	Project Reference Numbers	Area (acres)	Location
128	Brisa del mar	The project is a Tentative Map for a residential subdivision of 206 acres into 27 x 2-acre minimum lots.	06-0060719	206	31002 Aquaduct Road; 7520, 7530, 7570, 7574, 7650 Camino Del Rey
129	Canyon villas welk tm, rez and stp	The project is a Rezone and Tentative Map (TM 5313) to subdivide 20.89 acres into 177 time share units.	04-13850	20.89	28833, 28915 Champagne Blvd; 8860 Welk View Drive
130	Charles froehlich tm	The project is a residential subdivision of two parent parcels, resulting in a total of six lots. The site is located on Double K Road within the Valley Center Community Planning Group in unincorporated San Diego County.	06-0061043	--	Sierra Roja and Double K
131	Circle p lane tm5468rpl3	The project is a Major Subdivision of 11 proposed lots ranging in area from 1.03 to 2 gross acres on a 15.48-acre property with access via a private easement road from Mountain Meadows Road. The subject property is designated (2) Residential by the North County Metropolitan Subregional Plan	05-0055339	15.48	10264 Circle P Lane; 27446 Mountain Meadow Road
132	Dabbs tentative map	This is a request for a tentative map on 38.4 acres (gross acres). The subdivision proposes 9 lots. Each proposed lot will be 4 acres in size (net acres).	04-11658	38.4	32006 Aquaduct Road
133	Foxenwood prd tm4836 & stp89-041	Tentative Map to subdivide 45.2 acres into 17 dwelling units.	04-20362	45.2	Mirar De Valle
134	Golf green estates/s/site plan	116 Lot subdivisions of 6,000 square foot parcels.	06-0061925	--	Old River Road and Camino Del Rey
135	Kawano subdivision	Tentative Map to subdivide 10.51 into 8 residential lots.	04-0029730	10.51	1050 Ora Avo Drive
136	Mcintyre subdivision tm5014	Lilac Mtn Rch: 22-lot/108-ac	05-0060917	--	11278 Lilac Vista Drive;

**TABLE 6.1
CUMULATIVE PROJECTS**

Map Key #	Project	Description	Project Reference Numbers	Area (acres)	Location
137	Oak glen	The project proposes major subdivision of 20.01 acres. The subdivision proposes nine single family residences on 2 acre minimum lots. 9 Single Family Residential.	05-0046937	20.01	14099 West Oak Glen Road
138	Orchard vista, tm, rez	Withdrawn	06-0064848	--	13278 Orchard Vista Road
139	Pauma ranches	The project is a Tentative Map to subdivide 100 acres into 22 residential lots, with each lot no less than 4 acres in size.	06-0064845	100	30434 Montrachet Street;
140	Rabbit run, tm, 10 lots	The project is a major subdivision of 17.70 gross acres into 7 lots ranging in size from 2.03 to 4.02 gross acres.	06-0057789	17.7	29222, 29270 Duffwood Lane
141	West lilac farms i & ii	Approved Tentative Map for 28 single family lots on 92.8 acres.	04-14957	92.8	31817 Via Ararat Drive; 32542 Aquaduct Road
142	Boyer tpm 20794	Approved Tentative Parcel Map for 3 lots on 3 acres.	04-11552	3	
143	Cunningham, tpm, 2 lots	The project proposes to create two legal lots from Assessor Parcel Numbers 172-140-62 and 64. Parcel 1 is 7.40 net acres and Parcel 2 is 17.6 net acres.	05-0060144	25	1221 Tarek Trail
144	Fitzpatrick tpm	The project is a minor subdivision of a 10.8-acre parcel currently being used for agriculture (avocado grove). The project proposes to develop four residential lots ranging in size from 2.3 to 3.1 acre.	04-0023583	10.8	Tomsyl Road
145	Gangavalli, tpm, 2 lots	The project proposes to divide 5.05 net acres into 2 parcels measuring 2.51 acres gross (2.29 acres net), and 2.51 acres gross (2.45 acres net).	07-0086629	5.05	10418 King Sanday Lane
146	Goodnight ranchos, tpm, 2 lots	The project proposes to divide 5.0 acres into 2 parcels measuring 2.45 acres net each. The proposed parcels will have frontage upon Circle R Lane.	06-0058961	5.0	30359 Circle R Lane

**TABLE 6.1
CUMULATIVE PROJECTS**

Map Key #	Project	Description	Project Reference Numbers	Area (acres)	Location
147	Harlow minor subdivision (3 lots); tpm	3 Lot Subdivision	08-0096323	--	12542 Betsworth Road
148	Hefner/brown 4 lot and remainder tpm: tp	Subdivide a +/-57.9 acre parcel into four lots plus a remainder (lots range from 7.4 to 13.1 net acres).	09-0108702	57.9	31460 Aquaduct Road
149	Kim tentative parcel map	4 lots TPM w/ Remainder Parcel The project is a tentative parcel map application to subdivide a 46.72 acre parcel into 4 lots plus a remainder lot, ranging in area from 7.4 acres to 12.2 acres, for residential land use.	10-0135167	46.72	29640 Pamoosa Lane
150	Kirkorowicz, tpm,	The project proposes a two lot subdivision for the creation of two single-family residences and associated driveways and septic.	05-0054874	8.58	Fairview Road
151	Matheson, 2 lot tpm; tpm 21173	12.83 acres into 2 residential lots of 4.013 and 8.259 net acres.	10-0122579	12.83	1202 Rancho Luiseno Road
152	McBride, tpm, 2 lots	2-lot residential subdivision	07-0086911	--	29945 Spearhead Trail
153	McNally rd parcel map	The project proposes to divide 78.3 acres into 4 parcels and a remainder measuring 8.3 acres net, 4.2 acres net, 4.0 acres net, 4.0 acres net and 57.8 acres net, respectively.	06-0059622	78.3	McNally Road; Lilac Road
154	Modelmoa tpm	Tentative Parcel Map to subdivide 21.1 acres into 4 parcels and a remainder.	04-13025	21.1	30455 and 30463 Roadrunner Ridge South
155	Mustafa tpm	Tentative Parcel Map to subdivide 16.4 acres into 4 parcels and a remainder.	04-11418	16.4	9770 Circle R Road
156	Nichols whitman, tpm, 4 lots	TPM 4 Lots	05-0045920	--	10015 W Lilac Road
157	Rimsa tpm 2 lots	2 Single Family Residential lots	06-0058024	--	235 West Camino Calafia
158	Rios, tentative parcel map; tpm 21143	The project is a minor subdivision to create 2 parcels	08-0103568	--	12902 Mirar de Valle Road

**TABLE 6.1
CUMULATIVE PROJECTS**

Map Key #	Project	Description	Project Reference Numbers	Area (acres)	Location
159	Robinson, tpm, 4 lots	4 Single Family Residential lots	07-0087850	--	10127 Circle R Drive
160	Sage meadow tpm	2 Single Family Residential lots	06-0070181	--	13510 Sage Meadow Lane
161	Sanders, tpm, bc, 4 lots +	Tentative Parcel Map: Standard 4 lots plus a reminder lot	04-0022522	--	6993 W Lilac Road
162	Souris, tpm, 4 lots	Divide 38.8 net acres into 4 parcels ranging in size from 4.01 to 21.47 net acres. One existing single-family residence and guesthouse resides on Parcel 3 and will remain	05-0060924	38.8	14174 Sun Rocks Drive
163	Tran tentative parcel map	4 Single Family Residential lots	04-0021712	--	29623 Valley of the King Road
164	Turner, tpm	4 Single Family Residential lots	08-0090536	--	29133 Sandy Hill Drive
165	Weber, 4 lot tpm, tpm 21128	4 Single Family Residential lots	08-0097087	4.67	3458 Royal Road
166	Wild, tentative parcel map; tpm 21170	4 Single Family Residential lots	09-0117871	--	1560 Wild Acres Road
167	Yuan, minor subdivision + remainder, tpm	The project is a Tentative Map to subdivide 89.88 acres into four parcels plus a remainder parcel.	07-0082675	89.88	Old River Road and Dentre de Lomas
168	Pfaff, tpm, 3 lots	Tentative parcel map to divide a 7.79 acre parcel into three residential lots of 2.5, 2.1 and 2.7 net acres (Parcels 1, 2 and 3 respectively). The site contains an existing single-family residence on proposed Parcel 1 that would be retained.	06-0061790	7.79	32010 Caminito Quieto
169	Kohne residence, rez	Withdrawn	05-0045714	--	Calle Oro Verde
170	Castle creek condominiums, gpa, spa, rez	The project is a General Plan Amendment, Specific Plan Amendment, and Tentative Map to change the existing Land Use Designations to (21) Specific Plan Area in order to increase the density from 1.29 to 1.37 to allow a Tentative Map to subdivide the site into 63 dwelling units.	05-0061049	--	8790 Old Castle Road

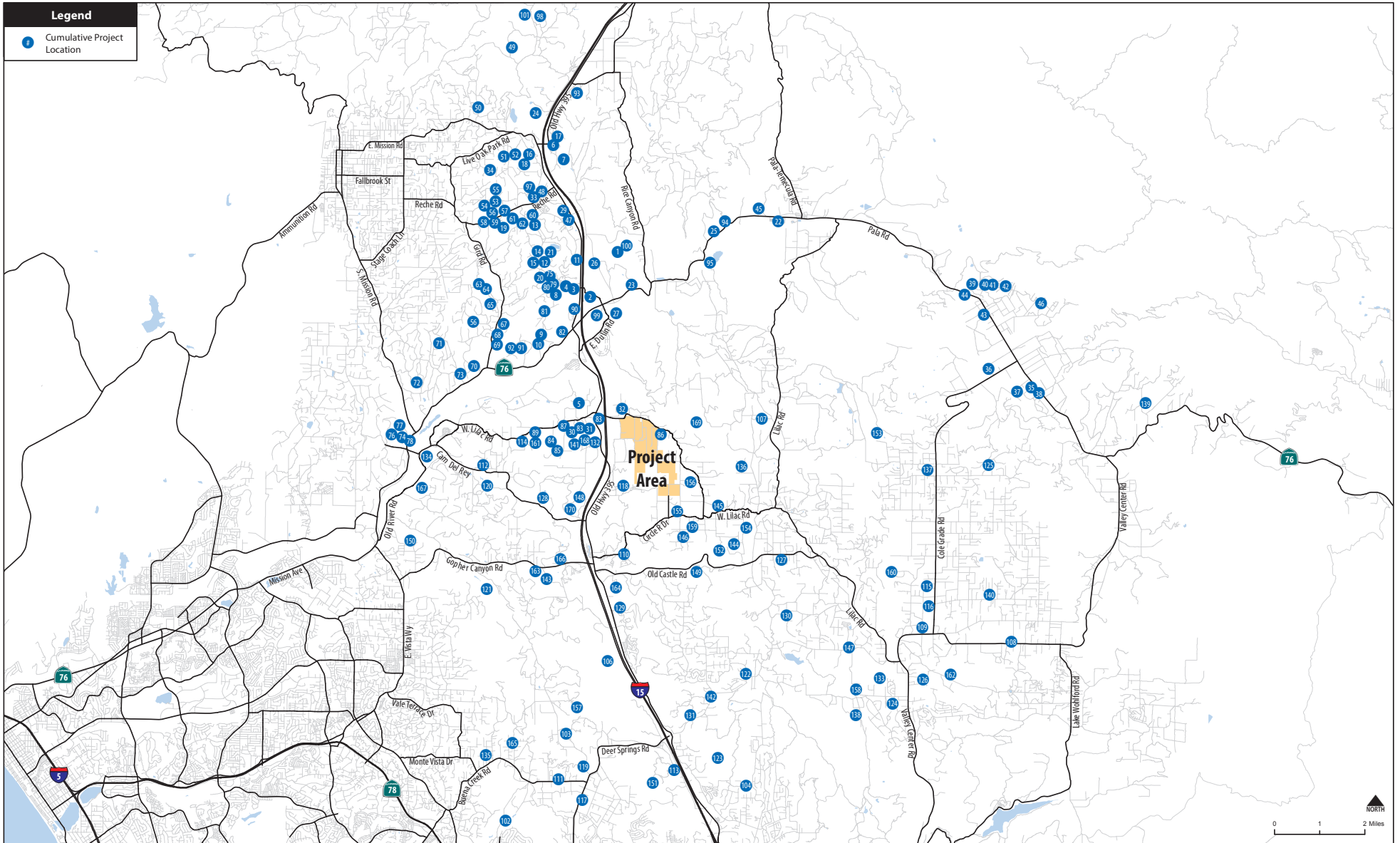

Lilac Hills Ranch Traffic Impact Study

Figure 6-1
Cumulative Project Locations

APPENDIX E

SITE ACCESS HCM INTERSECTION LOS AND QUEUING WORKSHEETS

Intersection						
Int Delay, s/veh	2.2					
Movement	EBL	EBT	WBT	WBR	SBL	SBR
Lane Configurations		↑	↑		↓	
Traffic Vol, veh/h	18	336	216	27	62	42
Future Vol, veh/h	18	336	216	27	62	42
Conflicting Peds, #/hr	0	0	0	0	0	0
Sign Control	Free	Free	Free	Free	Stop	Stop
RT Channelized	-	None	-	None	-	None
Storage Length	-	-	-	-	0	-
Veh in Median Storage, #	-	0	0	-	0	-
Grade, %	-	0	0	-	0	-
Peak Hour Factor	92	92	92	92	92	92
Heavy Vehicles, %	2	2	2	2	2	2
Mvmt Flow	20	365	235	29	67	46

Major/Minor	Major1	Major2	Minor2		
Conflicting Flow All	264	0	0	655	250
Stage 1	-	-	-	250	-
Stage 2	-	-	-	405	-
Critical Hdwy	4.12	-	-	6.42	6.22
Critical Hdwy Stg 1	-	-	-	5.42	-
Critical Hdwy Stg 2	-	-	-	5.42	-
Follow-up Hdwy	2.218	-	-	3.518	3.318
Pot Cap-1 Maneuver	1300	-	-	431	789
Stage 1	-	-	-	792	-
Stage 2	-	-	-	673	-
Platoon blocked, %		-	-		
Mov Cap-1 Maneuver	1300	-	-	423	789
Mov Cap-2 Maneuver	-	-	-	423	-
Stage 1	-	-	-	777	-
Stage 2	-	-	-	673	-

Approach	EB	WB	SB
HCM Control Delay, s	0.4	0	13.8
HCM LOS			B

Minor Lane/Major Mvmt	EBL	EBT	WBT	WBR	SBLn1
Capacity (veh/h)	1300	-	-	-	521
HCM Lane V/C Ratio	0.015	-	-	-	0.217
HCM Control Delay (s)	7.8	-	-	-	13.8
HCM Lane LOS	A	-	-	-	B
HCM 95th %tile Q(veh)	0	-	-	-	0.8

Intersection						
Int Delay, s/veh	2.3					
Movement	EBL	EBT	WBT	WBR	SBL	SBR
Lane Configurations		↑	↑		↓	
Traffic Vol, veh/h	18	380	201	29	67	42
Future Vol, veh/h	18	380	201	29	67	42
Conflicting Peds, #/hr	0	0	0	0	0	0
Sign Control	Free	Free	Free	Free	Stop	Stop
RT Channelized	-	None	-	None	-	None
Storage Length	-	-	-	-	0	-
Veh in Median Storage, #	-	0	0	-	0	-
Grade, %	-	0	0	-	0	-
Peak Hour Factor	92	92	92	92	92	92
Heavy Vehicles, %	2	2	2	2	2	2
Mvmt Flow	20	413	218	32	73	46

Major/Minor	Major1	Major2	Minor2		
Conflicting Flow All	250	0	-	0	687 234
Stage 1	-	-	-	-	234 -
Stage 2	-	-	-	-	453 -
Critical Hdwy	4.12	-	-	-	6.42 6.22
Critical Hdwy Stg 1	-	-	-	-	5.42 -
Critical Hdwy Stg 2	-	-	-	-	5.42 -
Follow-up Hdwy	2.218	-	-	-	3.518 3.318
Pot Cap-1 Maneuver	1316	-	-	-	413 805
Stage 1	-	-	-	-	805 -
Stage 2	-	-	-	-	640 -
Platoon blocked, %		-	-	-	
Mov Cap-1 Maneuver	1316	-	-	-	405 805
Mov Cap-2 Maneuver	-	-	-	-	405 -
Stage 1	-	-	-	-	789 -
Stage 2	-	-	-	-	640 -

Approach	EB	WB	SB
HCM Control Delay, s	0.4	0	14.4
HCM LOS			B

Minor Lane/Major Mvmt	EBL	EBT	WBT	WBR	SBLn1
Capacity (veh/h)	1316	-	-	-	501
HCM Lane V/C Ratio	0.015	-	-	-	0.236
HCM Control Delay (s)	7.8	-	-	-	14.4
HCM Lane LOS	A	-	-	-	B
HCM 95th %tile Q(veh)	0	-	-	-	0.9

Intersection						
Int Delay, s/veh	0.2					
Movement	EBL	EBR	NBL	NBT	SBT	SBR
Lane Configurations	↙	↗	↙	↑	↑	↗
Traffic Vol, veh/h	4	4	2	180	845	2
Future Vol, veh/h	4	4	2	180	845	2
Conflicting Peds, #/hr	0	0	0	0	0	0
Sign Control	Stop	Stop	Free	Free	Free	Free
RT Channelized	-	None	-	None	-	None
Storage Length	70	0	340	-	-	115
Veh in Median Storage, #	0	-	-	0	0	-
Grade, %	0	-	-	0	0	-
Peak Hour Factor	92	92	92	92	92	92
Heavy Vehicles, %	2	2	2	2	2	2
Mvmt Flow	4	4	2	196	918	2

Major/Minor	Minor2	Major1	Major2			
Conflicting Flow All	1118	918	920	0	-	0
Stage 1	918	-	-	-	-	-
Stage 2	200	-	-	-	-	-
Critical Hdwy	6.42	6.22	4.12	-	-	-
Critical Hdwy Stg 1	5.42	-	-	-	-	-
Critical Hdwy Stg 2	5.42	-	-	-	-	-
Follow-up Hdwy	3.518	3.318	2.218	-	-	-
Pot Cap-1 Maneuver	229	329	742	-	-	-
Stage 1	389	-	-	-	-	-
Stage 2	834	-	-	-	-	-
Platoon blocked, %				-	-	-
Mov Cap-1 Maneuver	228	329	742	-	-	-
Mov Cap-2 Maneuver	228	-	-	-	-	-
Stage 1	388	-	-	-	-	-
Stage 2	834	-	-	-	-	-

Approach	EB	NB	SB
HCM Control Delay, s	18.6	0.1	0
HCM LOS	C		

Minor Lane/Major Mvmt	NBL	NBT	EBLn1	EBLn2	SBT	SBR
Capacity (veh/h)	742	-	228	329	-	-
HCM Lane V/C Ratio	0.003	-	0.019	0.013	-	-
HCM Control Delay (s)	9.9	-	21.1	16.1	-	-
HCM Lane LOS	A	-	C	C	-	-
HCM 95th %tile Q(veh)	0	-	0.1	0	-	-

Intersection						
Int Delay, s/veh	2.2					
Movement	EBL	EBT	WBT	WBR	SBL	SBR
Lane Configurations		↑	↑		↓	
Traffic Vol, veh/h	53	170	130	78	33	23
Future Vol, veh/h	53	170	130	78	33	23
Conflicting Peds, #/hr	0	0	0	0	0	0
Sign Control	Free	Free	Free	Free	Stop	Stop
RT Channelized	-	None	-	None	-	None
Storage Length	-	-	-	-	0	-
Veh in Median Storage, #	-	0	0	-	0	-
Grade, %	-	0	0	-	0	-
Peak Hour Factor	92	92	92	92	92	92
Heavy Vehicles, %	2	2	2	2	2	2
Mvmt Flow	58	185	141	85	36	25

Major/Minor	Major1	Major2	Minor2		
Conflicting Flow All	226	0	0	485	184
Stage 1	-	-	-	184	-
Stage 2	-	-	-	301	-
Critical Hdwy	4.12	-	-	6.42	6.22
Critical Hdwy Stg 1	-	-	-	5.42	-
Critical Hdwy Stg 2	-	-	-	5.42	-
Follow-up Hdwy	2.218	-	-	3.518	3.318
Pot Cap-1 Maneuver	1342	-	-	541	858
Stage 1	-	-	-	848	-
Stage 2	-	-	-	751	-
Platoon blocked, %		-	-		
Mov Cap-1 Maneuver	1342	-	-	515	858
Mov Cap-2 Maneuver	-	-	-	515	-
Stage 1	-	-	-	807	-
Stage 2	-	-	-	751	-

Approach	EB	WB	SB
HCM Control Delay, s	1.9	0	11.5
HCM LOS			B

Minor Lane/Major Mvmt	EBL	EBT	WBT	WBR	SBLn1
Capacity (veh/h)	1342	-	-	-	616
HCM Lane V/C Ratio	0.043	-	-	-	0.099
HCM Control Delay (s)	7.8	-	-	-	11.5
HCM Lane LOS	A	-	-	-	B
HCM 95th %tile Q(veh)	0.1	-	-	-	0.3

Intersection						
Int Delay, s/veh	2.1					
Movement	EBL	EBT	WBT	WBR	SBL	SBR
Lane Configurations		↑	↑		↓	
Traffic Vol, veh/h	53	150	185	84	36	23
Future Vol, veh/h	53	150	185	84	36	23
Conflicting Peds, #/hr	0	0	0	0	0	0
Sign Control	Free	Free	Free	Free	Stop	Stop
RT Channelized	-	None	-	None	-	None
Storage Length	-	-	-	-	0	-
Veh in Median Storage, #	-	0	0	-	0	-
Grade, %	-	0	0	-	0	-
Peak Hour Factor	92	92	92	92	92	92
Heavy Vehicles, %	2	2	2	2	2	2
Mvmt Flow	58	163	201	91	39	25

Major/Minor	Major1	Major2	Minor2		
Conflicting Flow All	292	0	0	526	247
Stage 1	-	-	-	247	-
Stage 2	-	-	-	279	-
Critical Hdwy	4.12	-	-	6.42	6.22
Critical Hdwy Stg 1	-	-	-	5.42	-
Critical Hdwy Stg 2	-	-	-	5.42	-
Follow-up Hdwy	2.218	-	-	3.518	3.318
Pot Cap-1 Maneuver	1270	-	-	512	792
Stage 1	-	-	-	794	-
Stage 2	-	-	-	768	-
Platoon blocked, %		-	-		
Mov Cap-1 Maneuver	1270	-	-	486	792
Mov Cap-2 Maneuver	-	-	-	486	-
Stage 1	-	-	-	754	-
Stage 2	-	-	-	768	-

Approach	EB	WB	SB
HCM Control Delay, s	2.1	0	12.1
HCM LOS			B

Minor Lane/Major Mvmt	EBL	EBT	WBT	WBR	SBLn1
Capacity (veh/h)	1270	-	-	-	572
HCM Lane V/C Ratio	0.045	-	-	-	0.112
HCM Control Delay (s)	8	-	-	-	12.1
HCM Lane LOS	A	-	-	-	B
HCM 95th %tile Q(veh)	0.1	-	-	-	0.4

Intersection						
Int Delay, s/veh	0.1					
Movement	EBL	EBR	NBL	NBT	SBT	SBR
Lane Configurations	↘	↗	↘	↗	↗	↘
Traffic Vol, veh/h	2	2	6	358	202	6
Future Vol, veh/h	2	2	6	358	202	6
Conflicting Peds, #/hr	0	0	0	0	0	0
Sign Control	Stop	Stop	Free	Free	Free	Free
RT Channelized	-	None	-	None	-	None
Storage Length	70	0	340	-	-	115
Veh in Median Storage, #	0	-	-	0	0	-
Grade, %	0	-	-	0	0	-
Peak Hour Factor	92	92	92	92	92	92
Heavy Vehicles, %	2	2	2	2	2	2
Mvmt Flow	2	2	7	389	220	7

Major/Minor	Minor2	Major1	Major2			
Conflicting Flow All	623	220	227	0	-	0
Stage 1	220	-	-	-	-	-
Stage 2	403	-	-	-	-	-
Critical Hdwy	6.42	6.22	4.12	-	-	-
Critical Hdwy Stg 1	5.42	-	-	-	-	-
Critical Hdwy Stg 2	5.42	-	-	-	-	-
Follow-up Hdwy	3.518	3.318	2.218	-	-	-
Pot Cap-1 Maneuver	450	820	1341	-	-	-
Stage 1	817	-	-	-	-	-
Stage 2	675	-	-	-	-	-
Platoon blocked, %				-	-	-
Mov Cap-1 Maneuver	448	820	1341	-	-	-
Mov Cap-2 Maneuver	448	-	-	-	-	-
Stage 1	813	-	-	-	-	-
Stage 2	675	-	-	-	-	-

Approach	EB	NB	SB
HCM Control Delay, s	11.3	0.1	0
HCM LOS	B		

Minor Lane/Major Mvmt	NBL	NBT	EBLn1	EBLn2	SBT	SBR
Capacity (veh/h)	1341	-	448	820	-	-
HCM Lane V/C Ratio	0.005	-	0.005	0.003	-	-
HCM Control Delay (s)	7.7	-	13.1	9.4	-	-
HCM Lane LOS	A	-	B	A	-	-
HCM 95th %tile Q(veh)	0	-	0	0	-	-

Intersection						
Int Delay, s/veh	2.2					
Movement	EBL	EBT	WBT	WBR	SBL	SBR
Lane Configurations		↑	↑		↓	
Traffic Vol, veh/h	18	346	280	27	62	42
Future Vol, veh/h	18	346	280	27	62	42
Conflicting Peds, #/hr	0	0	0	0	0	0
Sign Control	Free	Free	Free	Free	Stop	Stop
RT Channelized	-	None	-	None	-	None
Storage Length	-	-	-	-	0	-
Veh in Median Storage, #	-	0	0	-	0	-
Grade, %	-	0	0	-	0	-
Peak Hour Factor	92	92	92	92	92	92
Heavy Vehicles, %	2	2	2	2	2	2
Mvmt Flow	20	376	304	29	67	46

Major/Minor	Major1	Major2	Minor2		
Conflicting Flow All	333	0	-	0	735 319
Stage 1	-	-	-	-	319 -
Stage 2	-	-	-	-	416 -
Critical Hdwy	4.12	-	-	-	6.42 6.22
Critical Hdwy Stg 1	-	-	-	-	5.42 -
Critical Hdwy Stg 2	-	-	-	-	5.42 -
Follow-up Hdwy	2.218	-	-	-	3.518 3.318
Pot Cap-1 Maneuver	1226	-	-	-	387 722
Stage 1	-	-	-	-	737 -
Stage 2	-	-	-	-	666 -
Platoon blocked, %		-	-	-	
Mov Cap-1 Maneuver	1226	-	-	-	379 722
Mov Cap-2 Maneuver	-	-	-	-	379 -
Stage 1	-	-	-	-	722 -
Stage 2	-	-	-	-	666 -

Approach	EB	WB	SB
HCM Control Delay, s	0.4	0	15.1
HCM LOS			C

Minor Lane/Major Mvmt	EBL	EBT	WBT	WBR	SBLn1
Capacity (veh/h)	1226	-	-	-	469
HCM Lane V/C Ratio	0.016	-	-	-	0.241
HCM Control Delay (s)	8	-	-	-	15.1
HCM Lane LOS	A	-	-	-	C
HCM 95th %tile Q(veh)	0	-	-	-	0.9

Intersection						
Int Delay, s/veh	3.1					
Movement	EBL	EBT	WBT	WBR	SBL	SBR
Lane Configurations		↑	↑		↓	
Traffic Vol, veh/h	18	390	675	29	67	42
Future Vol, veh/h	18	390	675	29	67	42
Conflicting Peds, #/hr	0	0	0	0	0	0
Sign Control	Free	Free	Free	Free	Stop	Stop
RT Channelized	-	None	-	None	-	None
Storage Length	-	-	-	-	0	-
Veh in Median Storage, #	-	0	0	-	0	-
Grade, %	-	0	0	-	0	-
Peak Hour Factor	92	92	92	92	92	92
Heavy Vehicles, %	2	2	2	2	2	2
Mvmt Flow	20	424	734	32	73	46

Major/Minor	Major1	Major2	Minor2		
Conflicting Flow All	766	0	-	0	1214 750
Stage 1	-	-	-	-	750 -
Stage 2	-	-	-	-	464 -
Critical Hdwy	4.12	-	-	-	6.42 6.22
Critical Hdwy Stg 1	-	-	-	-	5.42 -
Critical Hdwy Stg 2	-	-	-	-	5.42 -
Follow-up Hdwy	2.218	-	-	-	3.518 3.318
Pot Cap-1 Maneuver	847	-	-	-	201 411
Stage 1	-	-	-	-	467 -
Stage 2	-	-	-	-	633 -
Platoon blocked, %		-	-	-	
Mov Cap-1 Maneuver	847	-	-	-	195 411
Mov Cap-2 Maneuver	-	-	-	-	195 -
Stage 1	-	-	-	-	453 -
Stage 2	-	-	-	-	633 -

Approach	EB	WB	SB
HCM Control Delay, s	0.4	0	32.7
HCM LOS			D

Minor Lane/Major Mvmt	EBL	EBT	WBT	WBR	SBLn1
Capacity (veh/h)	847	-	-	-	245
HCM Lane V/C Ratio	0.023	-	-	-	0.484
HCM Control Delay (s)	9.4	-	-	-	32.7
HCM Lane LOS	A	-	-	-	D
HCM 95th %tile Q(veh)	0.1	-	-	-	2.4

Intersection						
Int Delay, s/veh	0.2					
Movement	EBL	EBR	NBL	NBT	SBT	SBR
Lane Configurations	↙	↗	↙	↗	↗	↗
Traffic Vol, veh/h	4	4	2	694	1309	2
Future Vol, veh/h	4	4	2	694	1309	2
Conflicting Peds, #/hr	0	0	0	0	0	0
Sign Control	Stop	Stop	Free	Free	Free	Free
RT Channelized	-	None	-	None	-	None
Storage Length	70	0	340	-	-	115
Veh in Median Storage, #	0	-	-	0	0	-
Grade, %	0	-	-	0	0	-
Peak Hour Factor	92	92	92	92	92	92
Heavy Vehicles, %	2	2	2	2	2	2
Mvmt Flow	4	4	2	754	1423	2

Major/Minor	Minor2	Major1	Major2			
Conflicting Flow All	2181	1423	1425	0	-	0
Stage 1	1423	-	-	-	-	-
Stage 2	758	-	-	-	-	-
Critical Hdwy	6.42	6.22	4.12	-	-	-
Critical Hdwy Stg 1	5.42	-	-	-	-	-
Critical Hdwy Stg 2	5.42	-	-	-	-	-
Follow-up Hdwy	3.518	3.318	2.218	-	-	-
Pot Cap-1 Maneuver	51	167	477	-	-	-
Stage 1	222	-	-	-	-	-
Stage 2	463	-	-	-	-	-
Platoon blocked, %				-	-	-
Mov Cap-1 Maneuver	51	167	477	-	-	-
Mov Cap-2 Maneuver	51	-	-	-	-	-
Stage 1	221	-	-	-	-	-
Stage 2	463	-	-	-	-	-

Approach	EB	NB	SB
HCM Control Delay, s	54.6	0	0
HCM LOS	F		

Minor Lane/Major Mvmt	NBL	NBT	EBLn1	EBLn2	SBT	SBR
Capacity (veh/h)	477	-	51	167	-	-
HCM Lane V/C Ratio	0.005	-	0.085	0.026	-	-
HCM Control Delay (s)	12.6	-	82.1	27.1	-	-
HCM Lane LOS	B	-	F	D	-	-
HCM 95th %tile Q(veh)	0	-	0.3	0.1	-	-

Intersection						
Int Delay, s/veh	1.8					
Movement	EBL	EBT	WBT	WBR	SBL	SBR
Lane Configurations		↑	↑		↑	
Traffic Vol, veh/h	53	282	196	78	33	23
Future Vol, veh/h	53	282	196	78	33	23
Conflicting Peds, #/hr	0	0	0	0	0	0
Sign Control	Free	Free	Free	Free	Stop	Stop
RT Channelized	-	None	-	None	-	None
Storage Length	-	-	-	-	0	-
Veh in Median Storage, #	-	0	0	-	0	-
Grade, %	-	0	0	-	0	-
Peak Hour Factor	92	92	92	92	92	92
Heavy Vehicles, %	2	2	2	2	2	2
Mvmt Flow	58	307	213	85	36	25

Major/Minor	Major1	Major2	Minor2		
Conflicting Flow All	298	0	-	0	679 256
Stage 1	-	-	-	-	256 -
Stage 2	-	-	-	-	423 -
Critical Hdwy	4.12	-	-	-	6.42 6.22
Critical Hdwy Stg 1	-	-	-	-	5.42 -
Critical Hdwy Stg 2	-	-	-	-	5.42 -
Follow-up Hdwy	2.218	-	-	-	3.518 3.318
Pot Cap-1 Maneuver	1263	-	-	-	417 783
Stage 1	-	-	-	-	787 -
Stage 2	-	-	-	-	661 -
Platoon blocked, %		-	-	-	
Mov Cap-1 Maneuver	1263	-	-	-	394 783
Mov Cap-2 Maneuver	-	-	-	-	394 -
Stage 1	-	-	-	-	744 -
Stage 2	-	-	-	-	661 -

Approach	EB	WB	SB
HCM Control Delay, s	1.3	0	13.3
HCM LOS			B

Minor Lane/Major Mvmt	EBL	EBT	WBT	WBR	SBLn1
Capacity (veh/h)	1263	-	-	-	495
HCM Lane V/C Ratio	0.046	-	-	-	0.123
HCM Control Delay (s)	8	-	-	-	13.3
HCM Lane LOS	A	-	-	-	B
HCM 95th %tile Q(veh)	0.1	-	-	-	0.4

Intersection						
Int Delay, s/veh	1.8					
Movement	EBL	EBT	WBT	WBR	SBL	SBR
Lane Configurations		↑	↑		↓	
Traffic Vol, veh/h	53	262	251	84	36	23
Future Vol, veh/h	53	262	251	84	36	23
Conflicting Peds, #/hr	0	0	0	0	0	0
Sign Control	Free	Free	Free	Free	Stop	Stop
RT Channelized	-	None	-	None	-	None
Storage Length	-	-	-	-	0	-
Veh in Median Storage, #	-	0	0	-	0	-
Grade, %	-	0	0	-	0	-
Peak Hour Factor	92	92	92	92	92	92
Heavy Vehicles, %	2	2	2	2	2	2
Mvmt Flow	58	285	273	91	39	25

Major/Minor	Major1	Major2	Minor2		
Conflicting Flow All	364	0	-	0	720
Stage 1	-	-	-	-	319
Stage 2	-	-	-	-	401
Critical Hdwy	4.12	-	-	-	6.42
Critical Hdwy Stg 1	-	-	-	-	5.42
Critical Hdwy Stg 2	-	-	-	-	5.42
Follow-up Hdwy	2.218	-	-	-	3.518
Pot Cap-1 Maneuver	1195	-	-	-	395
Stage 1	-	-	-	-	737
Stage 2	-	-	-	-	676
Platoon blocked, %		-	-	-	
Mov Cap-1 Maneuver	1195	-	-	-	372
Mov Cap-2 Maneuver	-	-	-	-	372
Stage 1	-	-	-	-	694
Stage 2	-	-	-	-	676

Approach	EB	WB	SB
HCM Control Delay, s	1.4	0	14.1
HCM LOS			B

Minor Lane/Major Mvmt	EBL	EBT	WBT	WBR	SBLn1
Capacity (veh/h)	1195	-	-	-	459
HCM Lane V/C Ratio	0.048	-	-	-	0.14
HCM Control Delay (s)	8.2	-	-	-	14.1
HCM Lane LOS	A	-	-	-	B
HCM 95th %tile Q(veh)	0.2	-	-	-	0.5

Intersection						
Int Delay, s/veh	0.1					
Movement	EBL	EBR	NBL	NBT	SBT	SBR
Lane Configurations	↙	↗	↙	↗	↗	↗
Traffic Vol, veh/h	2	2	6	731	705	6
Future Vol, veh/h	2	2	6	731	705	6
Conflicting Peds, #/hr	0	0	0	0	0	0
Sign Control	Stop	Stop	Free	Free	Free	Free
RT Channelized	-	None	-	None	-	None
Storage Length	70	0	340	-	-	115
Veh in Median Storage, #	0	-	-	0	0	-
Grade, %	0	-	-	0	0	-
Peak Hour Factor	92	92	92	92	92	92
Heavy Vehicles, %	2	2	2	2	2	2
Mvmt Flow	2	2	7	795	766	7

Major/Minor	Minor2	Major1	Major2			
Conflicting Flow All	1575	766	773	0	-	0
Stage 1	766	-	-	-	-	-
Stage 2	809	-	-	-	-	-
Critical Hdwy	6.42	6.22	4.12	-	-	-
Critical Hdwy Stg 1	5.42	-	-	-	-	-
Critical Hdwy Stg 2	5.42	-	-	-	-	-
Follow-up Hdwy	3.518	3.318	2.218	-	-	-
Pot Cap-1 Maneuver	121	403	842	-	-	-
Stage 1	459	-	-	-	-	-
Stage 2	438	-	-	-	-	-
Platoon blocked, %				-	-	-
Mov Cap-1 Maneuver	120	403	842	-	-	-
Mov Cap-2 Maneuver	120	-	-	-	-	-
Stage 1	455	-	-	-	-	-
Stage 2	438	-	-	-	-	-

Approach	EB	NB	SB
HCM Control Delay, s	24.8	0.1	0
HCM LOS	C		

Minor Lane/Major Mvmt	NBL	NBT	EBLn1	EBLn2	SBT	SBR
Capacity (veh/h)	842	-	120	403	-	-
HCM Lane V/C Ratio	0.008	-	0.018	0.005	-	-
HCM Control Delay (s)	9.3	-	35.6	14	-	-
HCM Lane LOS	A	-	E	B	-	-
HCM 95th %tile Q(veh)	0	-	0.1	0	-	-

Intersection: 21: W Lilac Road & Road A1

Movement	SB
Directions Served	LR
Maximum Queue (ft)	53
Average Queue (ft)	35
95th Queue (ft)	50
Link Distance (ft)	1231
Upstream Blk Time (%)	
Queuing Penalty (veh)	
Storage Bay Dist (ft)	
Storage Blk Time (%)	
Queuing Penalty (veh)	

Intersection: 22: W Lilac Road & Road A3

Movement	EB	SB
Directions Served	LT	LR
Maximum Queue (ft)	31	52
Average Queue (ft)	12	34
95th Queue (ft)	37	48
Link Distance (ft)	2058	1387
Upstream Blk Time (%)		
Queuing Penalty (veh)		
Storage Bay Dist (ft)		
Storage Blk Time (%)		
Queuing Penalty (veh)		

Intersection: 23: Old Highway 395 & Dulin Road Access

Movement	EB
Directions Served	R
Maximum Queue (ft)	20
Average Queue (ft)	7
95th Queue (ft)	22
Link Distance (ft)	2186
Upstream Blk Time (%)	
Queuing Penalty (veh)	
Storage Bay Dist (ft)	
Storage Blk Time (%)	
Queuing Penalty (veh)	

Zone Summary

Zone wide Queuing Penalty: 0

Intersection: 21: W Lilac Road & Road A1

Movement	SB
Directions Served	LR
Maximum Queue (ft)	54
Average Queue (ft)	39
95th Queue (ft)	56
Link Distance (ft)	1231
Upstream Blk Time (%)	
Queuing Penalty (veh)	
Storage Bay Dist (ft)	
Storage Blk Time (%)	
Queuing Penalty (veh)	

Intersection: 22: W Lilac Road & Road A3

Movement	EB	SB
Directions Served	LT	LR
Maximum Queue (ft)	72	71
Average Queue (ft)	25	32
95th Queue (ft)	76	69
Link Distance (ft)	2058	1387
Upstream Blk Time (%)		
Queuing Penalty (veh)		
Storage Bay Dist (ft)		
Storage Blk Time (%)		
Queuing Penalty (veh)		

Intersection: 23: Old Highway 395 & Dulin Road Access

Movement
Directions Served
Maximum Queue (ft)
Average Queue (ft)
95th Queue (ft)
Link Distance (ft)
Upstream Blk Time (%)
Queuing Penalty (veh)
Storage Bay Dist (ft)
Storage Blk Time (%)
Queuing Penalty (veh)

Zone Summary

Zone wide Queuing Penalty: 0

Intersection: 21: W Lilac Road & Road A1

Movement	EB	SB
Directions Served	LT	LR
Maximum Queue (ft)	54	55
Average Queue (ft)	11	40
95th Queue (ft)	47	59
Link Distance (ft)	2582	1231
Upstream Blk Time (%)		
Queuing Penalty (veh)		
Storage Bay Dist (ft)		
Storage Blk Time (%)		
Queuing Penalty (veh)		

Intersection: 22: W Lilac Road & Road A3

Movement	EB	SB
Directions Served	LT	LR
Maximum Queue (ft)	31	139
Average Queue (ft)	6	86
95th Queue (ft)	26	140
Link Distance (ft)	2058	1387
Upstream Blk Time (%)		
Queuing Penalty (veh)		
Storage Bay Dist (ft)		
Storage Blk Time (%)		
Queuing Penalty (veh)		

Intersection: 23: Old Highway 395 & Dulin Road Access

Movement	EB
Directions Served	L
Maximum Queue (ft)	47
Average Queue (ft)	9
95th Queue (ft)	41
Link Distance (ft)	
Upstream Blk Time (%)	
Queuing Penalty (veh)	
Storage Bay Dist (ft)	70
Storage Blk Time (%)	
Queuing Penalty (veh)	

Zone Summary

Zone wide Queuing Penalty: 0

Intersection: 21: W Lilac Road & Road A1

Movement	EB	SB
Directions Served	LT	LR
Maximum Queue (ft)	54	52
Average Queue (ft)	28	22
95th Queue (ft)	68	56
Link Distance (ft)	2582	1231
Upstream Blk Time (%)		
Queuing Penalty (veh)		
Storage Bay Dist (ft)		
Storage Blk Time (%)		
Queuing Penalty (veh)		

Intersection: 22: W Lilac Road & Road A3

Movement	EB	SB
Directions Served	LT	LR
Maximum Queue (ft)	31	79
Average Queue (ft)	12	34
95th Queue (ft)	37	76
Link Distance (ft)	2058	1387
Upstream Blk Time (%)		
Queuing Penalty (veh)		
Storage Bay Dist (ft)		
Storage Blk Time (%)		
Queuing Penalty (veh)		

Intersection: 23: Old Highway 395 & Dulin Road Access

Movement	EB	NB
Directions Served	R	L
Maximum Queue (ft)	20	31
Average Queue (ft)	4	6
95th Queue (ft)	17	27
Link Distance (ft)	2186	
Upstream Blk Time (%)		
Queuing Penalty (veh)		
Storage Bay Dist (ft)		340
Storage Blk Time (%)		
Queuing Penalty (veh)		

Zone Summary

Zone wide Queuing Penalty: 0

APPENDIX F







GENERAL PLAN (2030) TRAFFIC MODEL FORECAST PLOTS



**County of San Diego
GP Update EIR**

**2030 PLANNING
COMMISSION RECOMMENDED
LOS and Volume Plot**

FALLBROOK & BONSAI Area

2030 Proposed Network
Model Run 09/03/10
With Road 3A

- Levels of Service:
-  A - C
 -  D
 -  E
 -  F
-  Non-Circulation Element
 Zone Connector
 Traffic Analysis Zones

- Forecasted Volumes:
-  Adjusted Volume
 -  Unadjusted Volume

Level of Service Calculations
Peak Hour Standards for State Facilities
New County Daily ADT LOS Standards for non-State:

6.1	84	36000	54000	70000	86000	108000
6.2	75	22200	37000	44600	50000	57000
4.1A	74	14800	24700	29600	33400	37000
4.1B	86	13700	22800	27400	30800	34200
4.2A	59	5700	12500	19000	27000	32500
4.2B	71	5000	10900	17200	23500	30000
4.3C	41	2500	5450	8600	12500	15000
2.1A	56	2800	6500	10300	15000	20000
2.1B	64	3000	6000	9500	13500	19000
2.1C	64	3000	6000	9500	13500	19000
2.1D	52	3000	6000	9500	13500	19000
2.1E	48	1900	4100	7100	10600	16200
2.2A	50	3000	6000	9500	13500	19000
2.2B	65	3000	6000	9500	13500	19000
2.2C	65	3000	6000	9500	13500	19000
2.2D	50	3000	6000	9500	13500	19000
2.2E	45	1900	4100	7100	10600	16200
2.2F	45	1650	3300	5600	8700	16200
2.3A	54	1400	3000	5100	8900	12900
2.3B	66	1400	3000	5100	8900	12900
2.3C	42	1350	2700	4500	7000	11300
LPR	39	1350	2700	4500	7000	11300
LPR	34	1350	2700	4500	7000	11300

This traffic forecast is based on proprietary information of the County of San Diego and was produced to test the County's proposed DRAFT and BOARD land use assumptions. These data do not reflect SANDAG's 2030 Mobility Emphasis Cities/County Forecast.

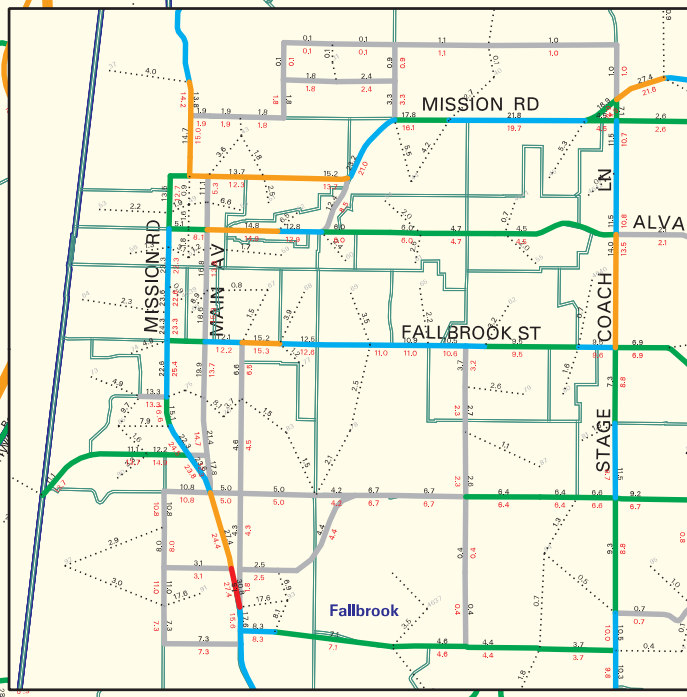
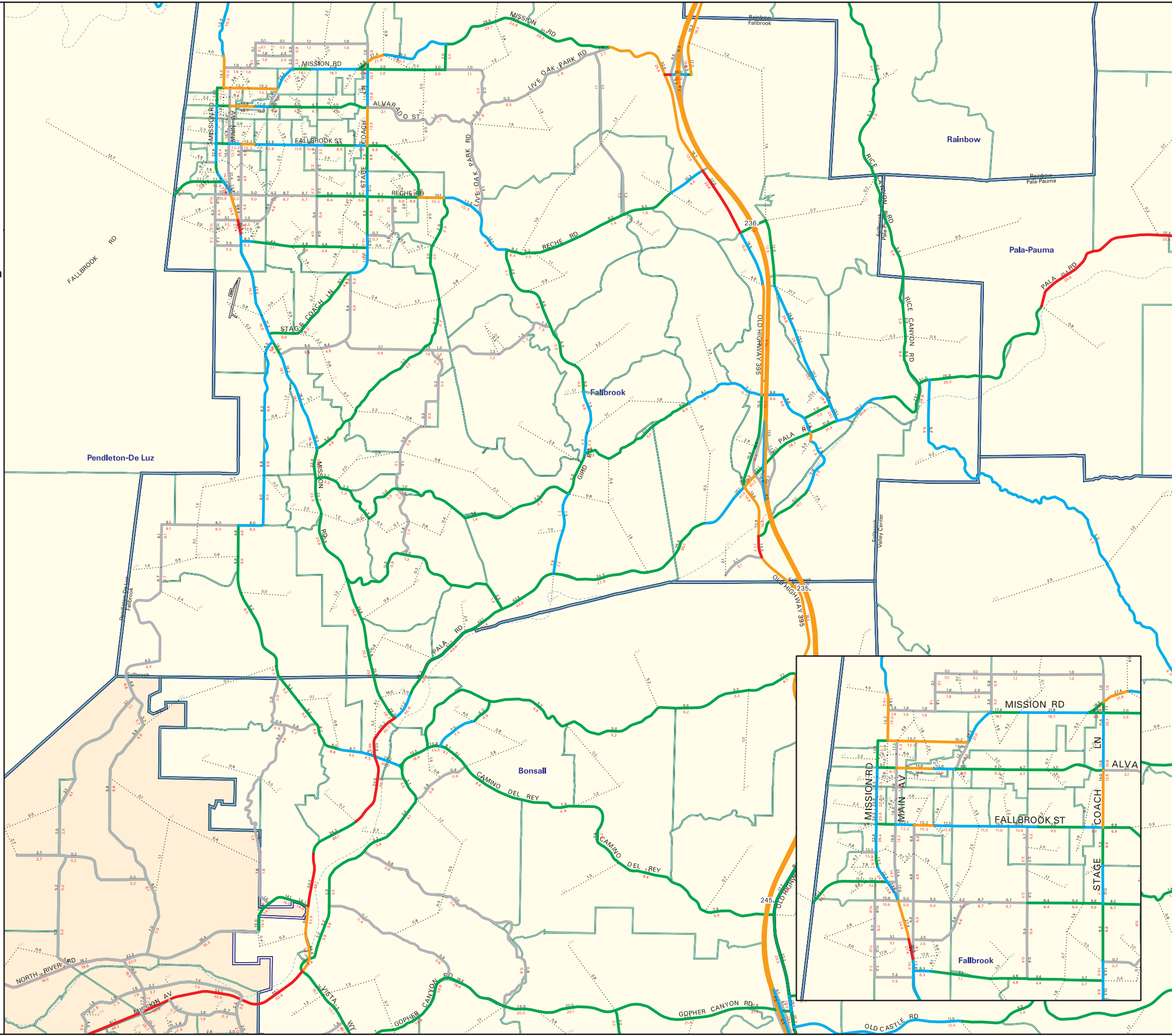
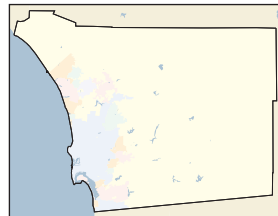

County of San Diego
GP Update EIR

2030 PLANNING
COMMISSION RECOMMENDED
LOS and Volume Plot

VALLEY CENTER Area

2030 Proposed Network
Model Rerun 09/03/10
With Road 3A

Levels of Service:

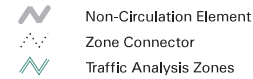

Forecasted Volumes:

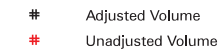

Level of Service Calculations

Peak Hour Standards for State Facilities
New County Daily ADT LOS Standards for non-State:

6.1	84	36000	54000	70000	86000	108000
6.2	75	22200	37000	44600	50000	57000
4.1A	74	14800	24700	29600	33400	37000
4.1B	86	13700	22800	27400	30800	34200
4.2A	59	5700	12500	19000	27000	32500
4.2B	71	5000	10900	17200	23000	28000
4.3C	41	2500	5450	8600	12500	15000
2.1A	56	2800	6500	10300	15000	20000
2.1B	64	3000	6000	9500	13500	19000
2.1C	64	3000	6000	9500	13500	19000
2.1D	52	3000	6000	9500	13500	19000
2.1E	48	1900	4100	7100	10900	16200
2.2A	50	3000	6000	9500	13500	19000
2.2B	65	3000	6000	9500	13500	19000
2.2C	65	3000	6000	9500	13500	19000
2.2D	50	3000	6000	9500	13500	19000
2.2E	45	1900	4100	7100	10900	16200
2.2F	45	1650	3300	5600	8700	12400
2.3A	54	1400	3000	5100	8000	12800
2.3B	68	1400	3000	5100	8000	12800
2.3C	42	1350	2700	4500	7000	11300
1PR	39	1350	2700	4500	7000	11300
1PR	34	1350	2700	4500	7000	11300

This traffic forecast is based on proprietary information of the County of San Diego and was produced to test the County's proposed DRAFT and BOARD land use assumptions. These data do not reflect SANDAG's 2030 Mobility Emphasis Cities/County Forecast.

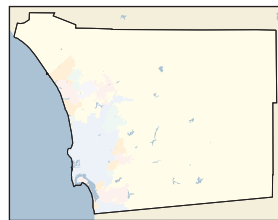

San Diego Region

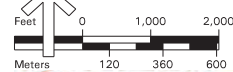

San Diego's Regional Planning Agency

September 3, 2010

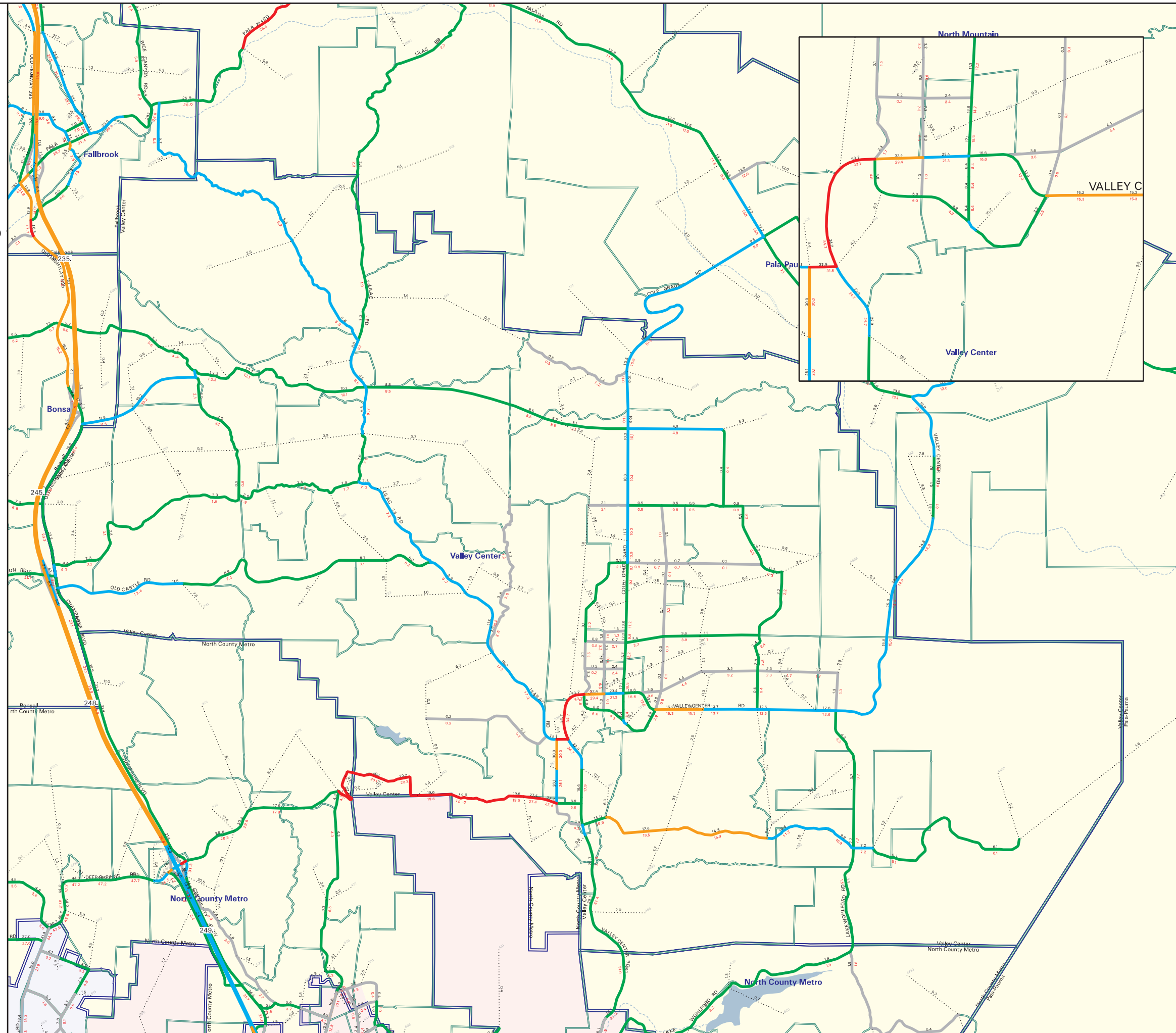

APPENDIX G

RECOMMENDED IMPROVEMENTS AND LOS WORKSHEETS

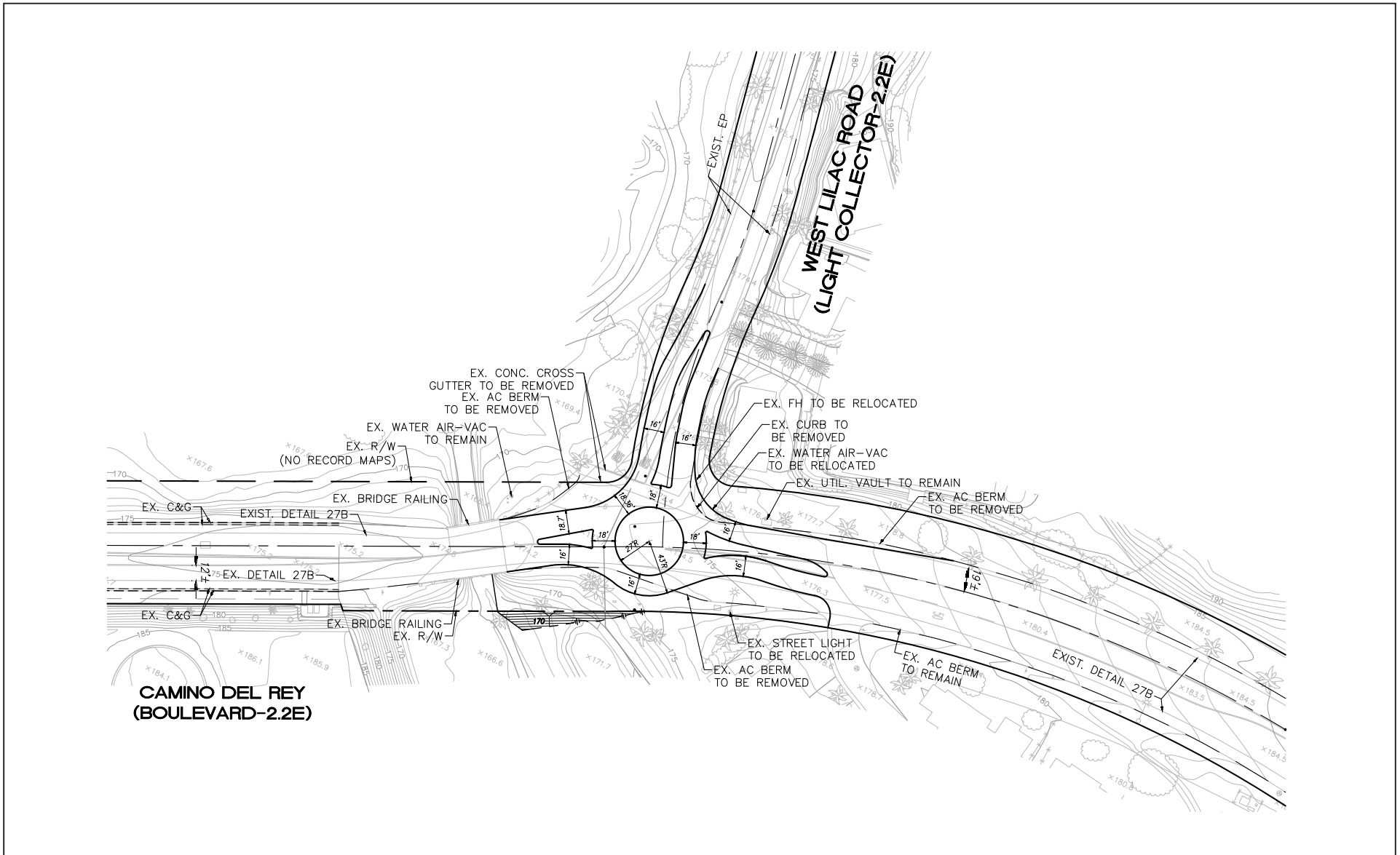

LSA

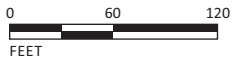

SOURCE: Project Design Consultants

I:\JCO1501\G\CaminoDelRey Roundabout.cdr (9/13/2019)

Ocean Breeze Ranch Traffic Impact Study
West Lilac Road/Camino Del Rey
Roundabout Conceptual Design

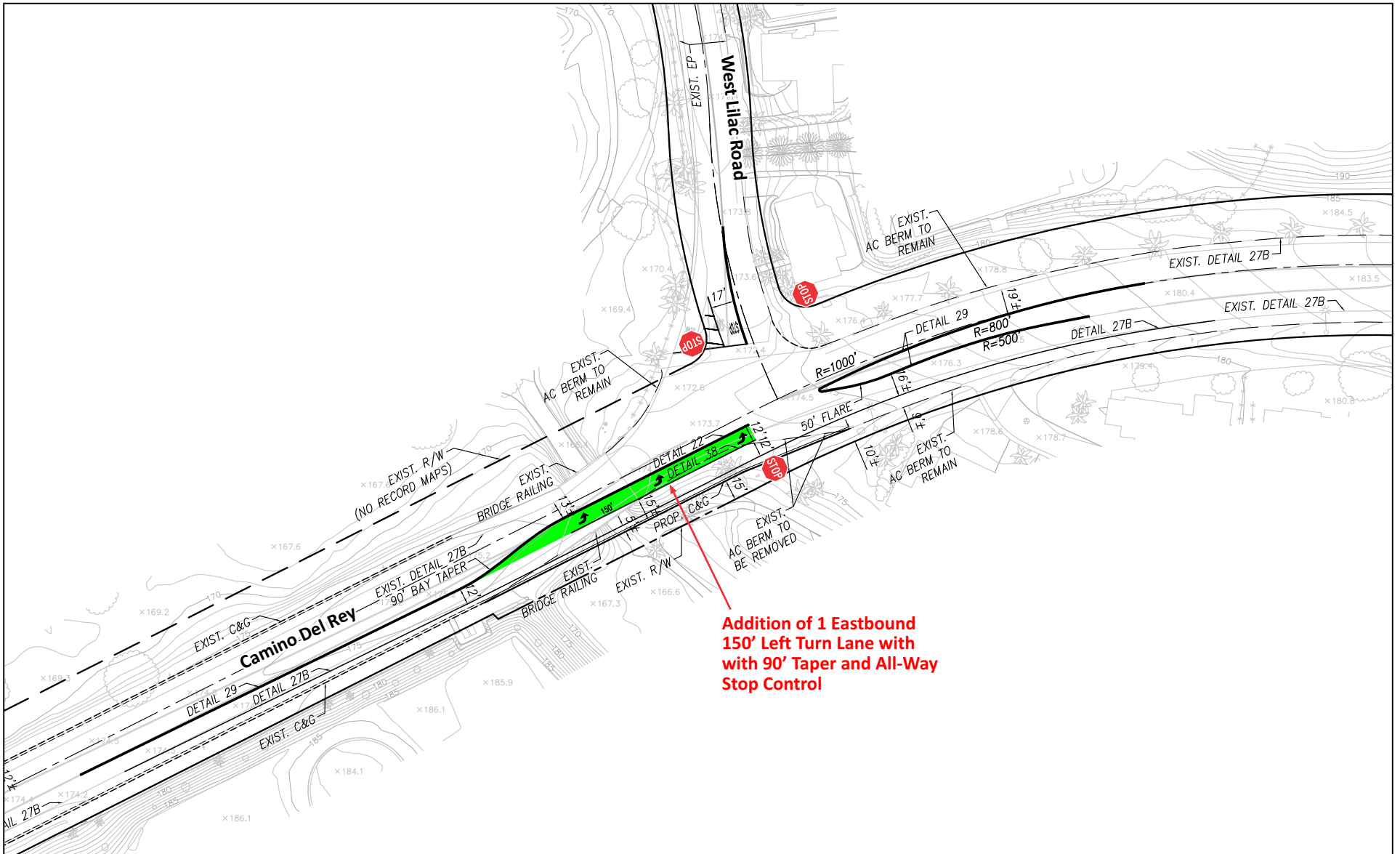

LSA

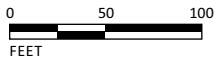

SOURCE: Project Design Consultants

I:\JCO1501\G\Striping-Lilac&Camino Del Rey.cdr (1/11/2019)

Ocean Breeze Ranch Traffic Impact Study
 West Lilac Road/Camino Del Rey
 Conceptual Striping

SITE LAYOUT

Site: 1 [Ocean Breeze Ranch Project]

New Site (Scenario: Cumulative + Project Condition - PM Peak Hour (Existing Geometry))
Roundabout

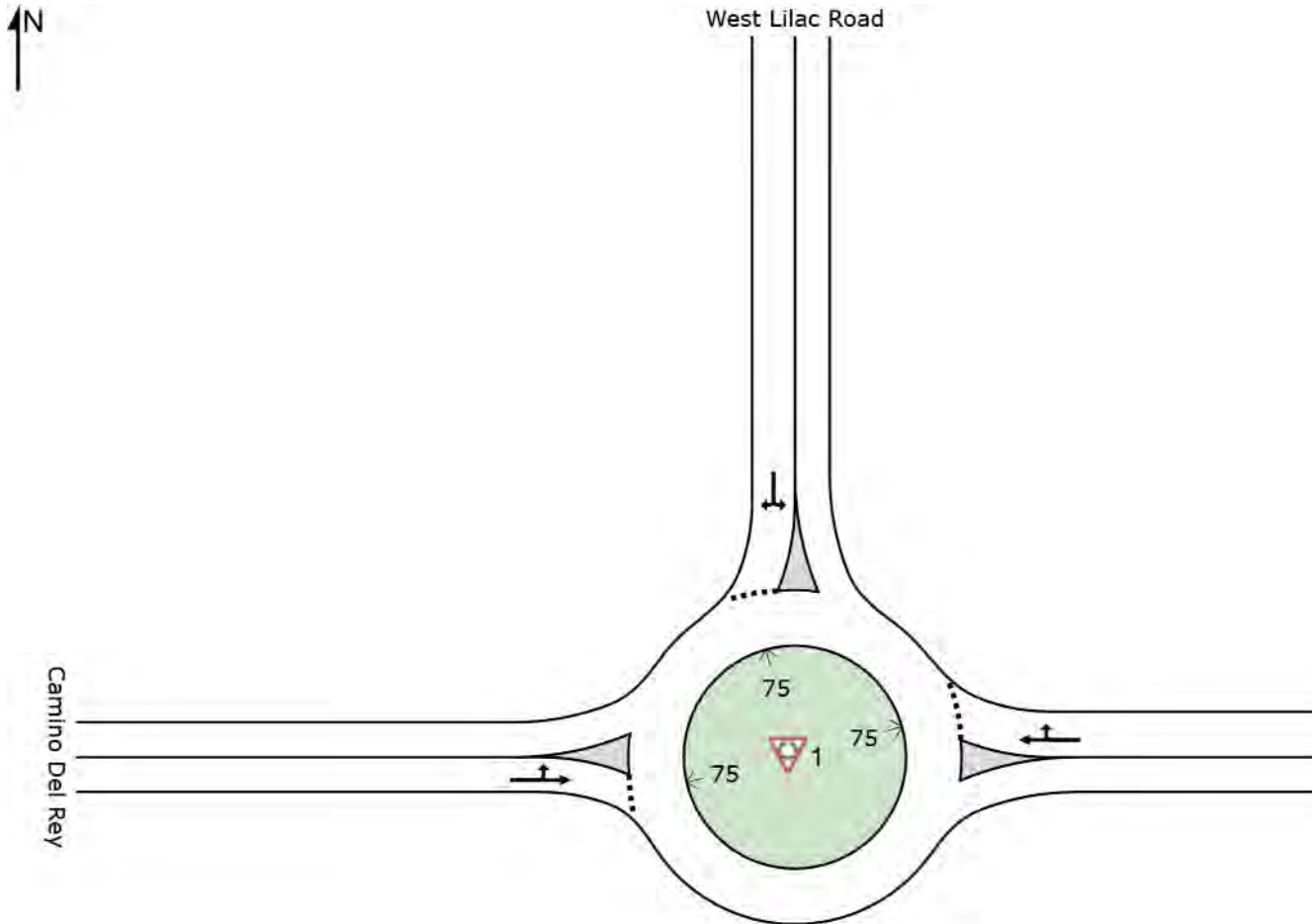

SIDRA INTERSECTION 7.0 | Copyright © 2000-2016 Akcelik and Associates Pty Ltd | sidrasolutions.com

Organisation: LSA ASSOCIATES, INC | Created: Friday, May 03, 2019 11:57:52 AM

Project: \\vCorp12\Projects\JCO1501\Sidra\West Lilac Road_Camino Del Rey_Existing Network_Cumul_P_PM.sip7

INTERSECTION SUMMARY

Site: 1 [Ocean Breeze Ranch Project]

New Site (Scenario: Existing + Project Condition - AM Peak Hour (Existing Geometry))
 Roundabout

Intersection Performance - Hourly Values		
Performance Measure	Vehicles	Persons
Travel Speed (Average)	31.7 mph	31.7 mph
Travel Distance (Total)	931.4 veh-mi/h	1117.7 pers-mi/h
Travel Time (Total)	29.4 veh-h/h	35.3 pers-h/h
Demand Flows (Total)	1484 veh/h	1780 pers/h
Percent Heavy Vehicles (Demand)	3.0 %	
Degree of Saturation	0.630	
Practical Spare Capacity	34.9 %	
Effective Intersection Capacity	2354 veh/h	
Control Delay (Total)	3.76 veh-h/h	4.51 pers-h/h
Control Delay (Average)	9.1 sec	9.1 sec
Control Delay (Worst Lane)	10.7 sec	
Control Delay (Worst Movement)	10.7 sec	10.7 sec
Geometric Delay (Average)	0.0 sec	
Stop-Line Delay (Average)	9.1 sec	
Idling Time (Average)	7.2 sec	
Intersection Level of Service (LOS)	LOS A	
95% Back of Queue - Vehicles (Worst Lane)	7.5 veh	
95% Back of Queue - Distance (Worst Lane)	192.9 ft	
Queue Storage Ratio (Worst Lane)	0.16	
Total Effective Stops	367 veh/h	441 pers/h
Effective Stop Rate	0.25 per veh	0.25 per pers
Proportion Queued	0.39	0.39
Performance Index	47.2	47.2
Cost (Total)	420.64 \$/h	420.64 \$/h
Fuel Consumption (Total)	38.9 gal/h	
Carbon Dioxide (Total)	349.0 kg/h	
Hydrocarbons (Total)	0.031 kg/h	
Carbon Monoxide (Total)	0.428 kg/h	
NOx (Total)	0.538 kg/h	

Site Level of Service (LOS) Method: Delay & v/c (HCM 2010). Site LOS Method is specified in the Parameter Settings dialog (Site tab).
 Roundabout LOS Method: SIDRA Roundabout LOS.

Intersection LOS value for Vehicles is based on average delay for all vehicle movements.

Roundabout Capacity Model: SIDRA Standard.

HCM Delay Formula option is used. Control Delay does not include Geometric Delay since Exclude Geometric Delay option applies.

Intersection Performance - Annual Values		
Performance Measure	Vehicles	Persons
Demand Flows (Total)	712,082 veh/y	854,498 pers/y
Delay	1,805 veh-h/y	2,166 pers-h/y
Effective Stops	176,231 veh/y	211,477 pers/y
Travel Distance	447,085 veh-mi/y	536,502 pers-mi/y
Travel Time	14,109 veh-h/y	16,931 pers-h/y
Cost	201,906 \$/y	201,906 \$/y
Fuel Consumption	18,691 gal/y	
Carbon Dioxide	167,528 kg/y	
Hydrocarbons	15 kg/y	
Carbon Monoxide	206 kg/y	
NOx	258 kg/y	

HCM 2010 Signalized Intersection Summary
3: Camino Del Rey & W Lilac Road

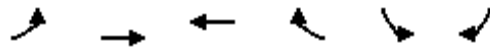

Movement	EBL	EBT	WBT	WBR	SBL	SBR		
Lane Configurations		↔	↔		↔	↔		
Traffic Volume (veh/h)	331	374	317	24	21	237		
Future Volume (veh/h)	331	374	317	24	21	237		
Number	7	4	8	18	1	16		
Initial Q (Qb), veh	0	0	0	0	0	0		
Ped-Bike Adj(A_pbT)	1.00			1.00	1.00	1.00		
Parking Bus, Adj	1.00	1.00	1.00	1.00	1.00	1.00		
Adj Sat Flow, veh/h/ln	1900	1863	1863	1900	1863	1863		
Adj Flow Rate, veh/h	368	416	352	27	23	0		
Adj No. of Lanes	0	1	1	0	1	1		
Peak Hour Factor	0.90	0.90	0.90	0.90	0.90	0.90		
Percent Heavy Veh, %	2	2	2	2	2	2		
Cap, veh/h	439	428	1178	90	371	331		
Arrive On Green	0.69	0.69	0.69	0.69	0.21	0.00		
Sat Flow, veh/h	550	621	1709	131	1774	1583		
Grp Volume(v), veh/h	784	0	0	379	23	0		
Grp Sat Flow(s),veh/h/ln	1171	0	0	1840	1774	1583		
Q Serve(g_s), s	50.1	0.0	0.0	7.1	0.9	0.0		
Cycle Q Clear(g_c), s	57.3	0.0	0.0	7.1	0.9	0.0		
Prop In Lane	0.47			0.07	1.00	1.00		
Lane Grp Cap(c), veh/h	867	0	0	1269	371	331		
V/C Ratio(X)	0.90	0.00	0.00	0.30	0.06	0.00		
Avail Cap(c_a), veh/h	888	0	0	1298	371	331		
HCM Platoon Ratio	1.00	1.00	1.00	1.00	1.00	1.00		
Upstream Filter(I)	1.00	0.00	0.00	1.00	1.00	0.00		
Uniform Delay (d), s/veh	16.6	0.0	0.0	5.4	28.1	0.0		
Incr Delay (d2), s/veh	12.4	0.0	0.0	0.1	0.3	0.0		
Initial Q Delay(d3),s/veh	0.0	0.0	0.0	0.0	0.0	0.0		
%ile BackOfQ(50%),veh/ln	21.1	0.0	0.0	3.6	0.5	0.0		
LnGrp Delay(d),s/veh	29.0	0.0	0.0	5.5	28.4	0.0		
LnGrp LOS	C			A	C			
Approach Vol, veh/h		784	379		23			
Approach Delay, s/veh		29.0	5.5		28.4			
Approach LOS		C	A		C			
Timer	1	2	3	4	5	6	7	8
Assigned Phs				4		6		8
Phs Duration (G+Y+Rc), s				65.6		23.0		65.6
Change Period (Y+Rc), s				4.5		4.5		4.5
Max Green Setting (Gmax), s				62.5		18.5		62.5
Max Q Clear Time (g_c+I1), s				59.3		2.9		9.1
Green Ext Time (p_c), s				1.8		0.0		2.6
Intersection Summary								
HCM 2010 Ctrl Delay			21.5					
HCM 2010 LOS			C					

HCM 2010 AWSC
3: Camino Del Rey & W Lilac Road

Existing+Project+Improvements AM
07/10/2019

Intersection	
Intersection Delay, s/veh	20.2
Intersection LOS	C





















Movement	EBL	EBT	WBT	WBR	SBL	SBR
Lane Configurations	↗	↑	↘		↗	↗
Traffic Vol, veh/h	331	374	317	24	21	237
Future Vol, veh/h	331	374	317	24	21	237
Peak Hour Factor	0.90	0.90	0.90	0.90	0.90	0.90
Heavy Vehicles, %	2	2	2	2	2	2
Mvmt Flow	368	416	352	27	23	263
Number of Lanes	1	1	1	0	1	1

Approach	EB	WB	SB
Opposing Approach	WB	EB	
Opposing Lanes	1	2	0
Conflicting Approach Left	SB		WB
Conflicting Lanes Left	2	0	1
Conflicting Approach Right		SB	EB
Conflicting Lanes Right	0	2	2
HCM Control Delay	22.1	20.2	15
HCM LOS	C	C	B

Lane	EBLn1	EBLn2	WBLn1	SBLn1	SBLn2
Vol Left, %	100%	0%	0%	100%	0%
Vol Thru, %	0%	100%	93%	0%	0%
Vol Right, %	0%	0%	7%	0%	100%
Sign Control	Stop	Stop	Stop	Stop	Stop
Traffic Vol by Lane	331	374	341	21	237
LT Vol	331	0	0	21	0
Through Vol	0	374	317	0	0
RT Vol	0	0	24	0	237
Lane Flow Rate	368	416	379	23	263
Geometry Grp	7	7	4	7	7
Degree of Util (X)	0.674	0.703	0.652	0.051	0.482
Departure Headway (Hd)	6.595	6.087	6.199	7.819	6.593
Convergence, Y/N	Yes	Yes	Yes	Yes	Yes
Cap	548	594	583	457	545
Service Time	4.35	3.841	4.249	5.58	4.353
HCM Lane V/C Ratio	0.672	0.7	0.65	0.05	0.483
HCM Control Delay	22	22.1	20.2	11	15.4
HCM Lane LOS	C	C	C	B	C
HCM 95th-tile Q	5	5.6	4.7	0.2	2.6

HCM 2010 Signalized Intersection Summary
6: Old Highway 395 & W. Lilac Road

Existing+Project+Improvements AM
07/10/2019

												
Movement	EBL	EBT	EBR	WBL	WBT	WBR	NBL	NBT	NBR	SBL	SBT	SBR
Lane Configurations												
Traffic Volume (veh/h)	125	14	133	24	25	16	89	41	8	19	588	119
Future Volume (veh/h)	125	14	133	24	25	16	89	41	8	19	588	119
Number	7	4	14	3	8	18	5	2	12	1	6	16
Initial Q (Qb), veh	0	0	0	0	0	0	0	0	0	0	0	0
Ped-Bike Adj(A_pbT)	1.00		1.00	1.00		1.00	1.00		1.00	1.00		1.00
Parking Bus, Adj	1.00	1.00	1.00	1.00	1.00	1.00	1.00	1.00	1.00	1.00	1.00	1.00
Adj Sat Flow, veh/h/ln	1900	1863	1863	1900	1863	1863	1863	1863	1900	1863	1863	1900
Adj Flow Rate, veh/h	132	15	0	25	26	0	94	43	8	20	619	125
Adj No. of Lanes	0	1	1	0	1	1	1	1	0	1	2	0
Peak Hour Factor	0.95	0.95	0.95	0.95	0.95	0.95	0.95	0.95	0.95	0.95	0.95	0.95
Percent Heavy Veh, %	2	2	2	2	2	2	2	2	2	2	2	2
Cap, veh/h	407	22	226	254	167	226	554	873	162	982	1677	338
Arrive On Green	0.14	0.14	0.00	0.14	0.14	0.00	0.57	0.57	0.57	0.57	0.57	0.57
Sat Flow, veh/h	1327	151	1583	586	1167	1583	713	1528	284	1348	2936	592
Grp Volume(v), veh/h	147	0	0	51	0	0	94	0	51	20	373	371
Grp Sat Flow(s),veh/h/ln	1478	0	1583	1753	0	1583	713	0	1813	1348	1770	1758
Q Serve(g_s), s	2.1	0.0	0.0	0.0	0.0	0.0	2.6	0.0	0.4	0.2	3.6	3.6
Cycle Q Clear(g_c), s	2.9	0.0	0.0	0.8	0.0	0.0	6.2	0.0	0.4	0.6	3.6	3.6
Prop In Lane	0.90		1.00	0.49		1.00	1.00		0.16	1.00		0.34
Lane Grp Cap(c), veh/h	428	0	226	421	0	226	554	0	1036	982	1011	1005
V/C Ratio(X)	0.34	0.00	0.00	0.12	0.00	0.00	0.17	0.00	0.05	0.02	0.37	0.37
Avail Cap(c_a), veh/h	1035	0	905	1106	0	905	554	0	1036	982	1011	1005
HCM Platoon Ratio	1.00	1.00	1.00	1.00	1.00	1.00	1.00	1.00	1.00	1.00	1.00	1.00
Upstream Filter(I)	1.00	0.00	0.00	1.00	0.00	0.00	1.00	0.00	1.00	1.00	1.00	1.00
Uniform Delay (d), s/veh	12.7	0.0	0.0	11.9	0.0	0.0	5.4	0.0	3.0	3.1	3.7	3.7
Incr Delay (d2), s/veh	0.5	0.0	0.0	0.1	0.0	0.0	0.7	0.0	0.1	0.0	1.0	1.0
Initial Q Delay(d3),s/veh	0.0	0.0	0.0	0.0	0.0	0.0	0.0	0.0	0.0	0.0	0.0	0.0
%ile BackOfQ(50%),veh/ln	1.2	0.0	0.0	0.4	0.0	0.0	0.6	0.0	0.2	0.1	1.9	1.9
LnGrp Delay(d),s/veh	13.2	0.0	0.0	12.0	0.0	0.0	6.0	0.0	3.1	3.1	4.7	4.7
LnGrp LOS	B			B			A		A	A	A	A
Approach Vol, veh/h		147			51			145			764	
Approach Delay, s/veh		13.2			12.0			5.0			4.7	
Approach LOS		B			B			A			A	
Timer	1	2	3	4	5	6	7	8				
Assigned Phs		2		4		6		8				
Phs Duration (G+Y+Rc), s		22.5		9.0		22.5		9.0				
Change Period (Y+Rc), s		4.5		4.5		4.5		4.5				
Max Green Setting (Gmax), s		18.0		18.0		18.0		18.0				
Max Q Clear Time (g_c+I1), s		8.2		4.9		5.6		2.8				
Green Ext Time (p_c), s		0.6		0.6		3.9		0.1				
Intersection Summary												
HCM 2010 Ctrl Delay			6.2									
HCM 2010 LOS			A									

INTERSECTION SUMMARY

 Site: 1 [Ocean Breeze Ranch Project]

New Site (Scenario: Existing + Project Condition - PM Peak Hour (Existing Geometry))
 Roundabout

Intersection Performance - Hourly Values		
Performance Measure	Vehicles	Persons
Travel Speed (Average)	32.9 mph	32.9 mph
Travel Distance (Total)	717.4 veh-mi/h	860.9 pers-mi/h
Travel Time (Total)	21.8 veh-h/h	26.1 pers-h/h
Demand Flows (Total)	1144 veh/h	1372 pers/h
Percent Heavy Vehicles (Demand)	3.0 %	
Degree of Saturation	0.440	
Practical Spare Capacity	93.1 %	
Effective Intersection Capacity	2598 veh/h	
Control Delay (Total)	2.19 veh-h/h	2.62 pers-h/h
Control Delay (Average)	6.9 sec	6.9 sec
Control Delay (Worst Lane)	7.8 sec	
Control Delay (Worst Movement)	7.8 sec	7.8 sec
Geometric Delay (Average)	0.0 sec	
Stop-Line Delay (Average)	6.9 sec	
Idling Time (Average)	5.3 sec	
Intersection Level of Service (LOS)	LOS A	
95% Back of Queue - Vehicles (Worst Lane)	2.9 veh	
95% Back of Queue - Distance (Worst Lane)	74.7 ft	
Queue Storage Ratio (Worst Lane)	0.06	
Total Effective Stops	222 veh/h	267 pers/h
Effective Stop Rate	0.19 per veh	0.19 per pers
Proportion Queued	0.30	0.30
Performance Index	31.3	31.3
Cost (Total)	306.38 \$/h	306.38 \$/h
Fuel Consumption (Total)	29.2 gal/h	
Carbon Dioxide (Total)	261.7 kg/h	
Hydrocarbons (Total)	0.023 kg/h	
Carbon Monoxide (Total)	0.323 kg/h	
NOx (Total)	0.405 kg/h	

Site Level of Service (LOS) Method: Delay & v/c (HCM 2010). Site LOS Method is specified in the Parameter Settings dialog (Site tab).
 Roundabout LOS Method: SIDRA Roundabout LOS.

Intersection LOS value for Vehicles is based on average delay for all vehicle movements.

Roundabout Capacity Model: SIDRA Standard.

HCM Delay Formula option is used. Control Delay does not include Geometric Delay since Exclude Geometric Delay option applies.

Intersection Performance - Annual Values		
Performance Measure	Vehicles	Persons
Demand Flows (Total)	548,931 veh/y	658,717 pers/y
Delay	1,049 veh-h/y	1,259 pers-h/y
Effective Stops	106,622 veh/y	127,946 pers/y
Travel Distance	344,351 veh-mi/y	413,221 pers-mi/y
Travel Time	10,451 veh-h/y	12,542 pers-h/y
Cost	147,062 \$/y	147,062 \$/y
Fuel Consumption	14,015 gal/y	
Carbon Dioxide	125,631 kg/y	
Hydrocarbons	11 kg/y	
Carbon Monoxide	155 kg/y	
NOx	194 kg/y	

HCM 2010 Signalized Intersection Summary
3: Camino Del Rey & W Lilac Road

Existing+Project+Improvements AM
07/10/2019

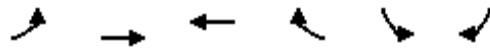

Movement	EBL	EBT	WBT	WBR	SBL	SBR		
Lane Configurations		↔	↔		↔	↔		
Traffic Volume (veh/h)	197	264	451	27	8	144		
Future Volume (veh/h)	197	264	451	27	8	144		
Number	7	4	8	18	1	16		
Initial Q (Qb), veh	0	0	0	0	0	0		
Ped-Bike Adj(A_pbT)	1.00			1.00	1.00	1.00		
Parking Bus, Adj	1.00	1.00	1.00	1.00	1.00	1.00		
Adj Sat Flow, veh/h/ln	1900	1863	1863	1900	1863	1863		
Adj Flow Rate, veh/h	216	290	496	30	9	0		
Adj No. of Lanes	0	1	1	0	1	1		
Peak Hour Factor	0.91	0.91	0.91	0.91	0.91	0.91		
Percent Heavy Veh, %	2	2	2	2	2	2		
Cap, veh/h	284	351	962	58	533	476		
Arrive On Green	0.55	0.55	0.55	0.55	0.30	0.00		
Sat Flow, veh/h	363	634	1739	105	1774	1583		
Grp Volume(v), veh/h	506	0	0	526	9	0		
Grp Sat Flow(s),veh/h/ln	998	0	0	1844	1774	1583		
Q Serve(g_s), s	19.3	0.0	0.0	11.0	0.2	0.0		
Cycle Q Clear(g_c), s	30.3	0.0	0.0	11.0	0.2	0.0		
Prop In Lane	0.43			0.06	1.00	1.00		
Lane Grp Cap(c), veh/h	635	0	0	1020	533	476		
V/C Ratio(X)	0.80	0.00	0.00	0.52	0.02	0.00		
Avail Cap(c_a), veh/h	706	0	0	1124	533	476		
HCM Platoon Ratio	1.00	1.00	1.00	1.00	1.00	1.00		
Upstream Filter(I)	1.00	0.00	0.00	1.00	1.00	0.00		
Uniform Delay (d), s/veh	15.0	0.0	0.0	8.6	15.1	0.0		
Incr Delay (d2), s/veh	5.8	0.0	0.0	0.4	0.1	0.0		
Initial Q Delay(d3),s/veh	0.0	0.0	0.0	0.0	0.0	0.0		
%ile BackOfQ(50%),veh/ln	9.0	0.0	0.0	5.7	0.1	0.0		
LnGrp Delay(d),s/veh	20.8	0.0	0.0	9.0	15.2	0.0		
LnGrp LOS	C			A	B			
Approach Vol, veh/h		506	526		9			
Approach Delay, s/veh		20.8	9.0		15.2			
Approach LOS		C	A		B			
Timer	1	2	3	4	5	6	7	8
Assigned Phs				4		6		8
Phs Duration (G+Y+Rc), s				38.5		23.0		38.5
Change Period (Y+Rc), s				4.5		4.5		4.5
Max Green Setting (Gmax), s				37.5		18.5		37.5
Max Q Clear Time (g_c+I1), s				32.3		2.2		13.0
Green Ext Time (p_c), s				1.7		0.0		3.6
Intersection Summary								
HCM 2010 Ctrl Delay			14.8					
HCM 2010 LOS			B					

Intersection	
Intersection Delay, s/veh	18.8
Intersection LOS	C

Movement	EBL	EBT	WBT	WBR	SBL	SBR
Lane Configurations	↘	↑	↘		↘	↗
Traffic Vol, veh/h	197	264	451	27	8	145
Future Vol, veh/h	197	264	451	27	8	145
Peak Hour Factor	0.91	0.91	0.91	0.91	0.91	0.91
Heavy Vehicles, %	2	2	2	2	2	2
Mvmt Flow	216	290	496	30	9	159
Number of Lanes	1	1	1	0	1	1





















Approach	EB	WB	SB
Opposing Approach	WB	EB	
Opposing Lanes	1	2	0
Conflicting Approach Left	SB		WB
Conflicting Lanes Left	2	0	1
Conflicting Approach Right		SB	EB
Conflicting Lanes Right	0	2	2
HCM Control Delay	12.9	26.8	11.4
HCM LOS	B	D	B

Lane	EBLn1	EBLn2	WBLn1	SBLn1	SBLn2
Vol Left, %	100%	0%	0%	100%	0%
Vol Thru, %	0%	100%	94%	0%	0%
Vol Right, %	0%	0%	6%	0%	100%
Sign Control	Stop	Stop	Stop	Stop	Stop
Traffic Vol by Lane	197	264	478	8	145
LT Vol	197	0	0	8	0
Through Vol	0	264	451	0	0
RT Vol	0	0	27	0	145
Lane Flow Rate	216	290	525	9	159
Geometry Grp	7	7	4	7	7
Degree of Util (X)	0.372	0.458	0.8	0.018	0.28
Departure Headway (Hd)	6.194	5.688	5.484	7.554	6.329
Convergence, Y/N	Yes	Yes	Yes	Yes	Yes
Cap	582	635	662	474	567
Service Time	3.924	3.417	3.509	5.294	4.068
HCM Lane V/C Ratio	0.371	0.457	0.793	0.019	0.28
HCM Control Delay	12.6	13.2	26.8	10.4	11.5
HCM Lane LOS	B	B	D	B	B
HCM 95th-tile Q	1.7	2.4	8	0.1	1.1

HCM 2010 Signalized Intersection Summary
6: Old Highway 395 & W. Lilac Road

Existing+Project+Improvements PM

07/10/2019

												
Movement	EBL	EBT	EBR	WBL	WBT	WBR	NBL	NBT	NBR	SBL	SBT	SBR
Lane Configurations												
Traffic Volume (veh/h)	60	14	69	14	14	32	143	272	34	23	102	80
Future Volume (veh/h)	60	14	69	14	14	32	143	272	34	23	102	80
Number	7	4	14	3	8	18	5	2	12	1	6	16
Initial Q (Qb), veh	0	0	0	0	0	0	0	0	0	0	0	0
Ped-Bike Adj(A_pbT)	1.00		1.00	1.00		1.00	1.00		1.00	1.00		1.00
Parking Bus, Adj	1.00	1.00	1.00	1.00	1.00	1.00	1.00	1.00	1.00	1.00	1.00	1.00
Adj Sat Flow, veh/h/ln	1900	1863	1863	1900	1863	1863	1863	1863	1900	1863	1863	1900
Adj Flow Rate, veh/h	70	16	0	16	16	0	166	316	40	27	119	93
Adj No. of Lanes	0	1	1	0	1	1	1	1	0	1	2	0
Peak Hour Factor	0.86	0.86	0.86	0.86	0.86	0.86	0.86	0.86	0.86	0.86	0.86	0.86
Percent Heavy Veh, %	2	2	2	2	2	2	2	2	2	2	2	2
Cap, veh/h	345	29	165	251	106	165	902	968	123	749	1172	848
Arrive On Green	0.10	0.10	0.00	0.10	0.10	0.00	0.60	0.60	0.60	0.60	0.60	0.60
Sat Flow, veh/h	1229	281	1583	694	1019	1583	1165	1621	205	1021	1962	1420
Grp Volume(v), veh/h	86	0	0	32	0	0	166	0	356	27	106	106
Grp Sat Flow(s),veh/h/ln	1510	0	1583	1714	0	1583	1165	0	1827	1021	1770	1612
Q Serve(g_s), s	1.1	0.0	0.0	0.0	0.0	0.0	2.2	0.0	2.9	0.4	0.8	0.9
Cycle Q Clear(g_c), s	1.6	0.0	0.0	0.5	0.0	0.0	3.0	0.0	2.9	3.3	0.8	0.9
Prop In Lane	0.81		1.00	0.50		1.00	1.00		0.11	1.00		0.88
Lane Grp Cap(c), veh/h	374	0	165	358	0	165	902	0	1091	749	1057	963
V/C Ratio(X)	0.23	0.00	0.00	0.09	0.00	0.00	0.18	0.00	0.33	0.04	0.10	0.11
Avail Cap(c_a), veh/h	1094	0	946	1143	0	946	902	0	1091	749	1057	963
HCM Platoon Ratio	1.00	1.00	1.00	1.00	1.00	1.00	1.00	1.00	1.00	1.00	1.00	1.00
Upstream Filter(I)	1.00	0.00	0.00	1.00	0.00	0.00	1.00	0.00	1.00	1.00	1.00	1.00
Uniform Delay (d), s/veh	12.8	0.0	0.0	12.3	0.0	0.0	3.3	0.0	3.0	3.9	2.6	2.6
Incr Delay (d2), s/veh	0.3	0.0	0.0	0.1	0.0	0.0	0.4	0.0	0.8	0.1	0.2	0.2
Initial Q Delay(d3),s/veh	0.0	0.0	0.0	0.0	0.0	0.0	0.0	0.0	0.0	0.0	0.0	0.0
%ile BackOfQ(50%),veh/ln	0.7	0.0	0.0	0.3	0.0	0.0	0.8	0.0	1.6	0.1	0.4	0.4
LnGrp Delay(d),s/veh	13.1	0.0	0.0	12.4	0.0	0.0	3.7	0.0	3.8	4.0	2.8	2.8
LnGrp LOS	B			B			A		A	A	A	A
Approach Vol, veh/h		86			32			522			239	
Approach Delay, s/veh		13.1			12.4			3.8			2.9	
Approach LOS		B			B			A			A	
Timer	1	2	3	4	5	6	7	8				
Assigned Phs		2		4		6		8				
Phs Duration (G+Y+Rc), s		22.5		7.6		22.5		7.6				
Change Period (Y+Rc), s		4.5		4.5		4.5		4.5				
Max Green Setting (Gmax), s		18.0		18.0		18.0		18.0				
Max Q Clear Time (g_c+I1), s		5.0		3.6		5.3		2.5				
Green Ext Time (p_c), s		2.4		0.3		1.0		0.1				
Intersection Summary												
HCM 2010 Ctrl Delay			4.8									
HCM 2010 LOS			A									

Intersection 3: West Lilac Road/Camino Del Rey

INTERSECTION SUMMARY

 Site: 1 [Ocean Breeze Ranch Project]

New Site (Scenario: Cumulative + Project Condition - AM Peak Hour (Existing Geometry))
Roundabout

Intersection Performance - Hourly Values		
Performance Measure	Vehicles	Persons
Travel Speed (Average)	28.9 mph	28.9 mph
Travel Distance (Total)	1220.8 veh-mi/h	1464.9 pers-mi/h
Travel Time (Total)	42.3 veh-h/h	50.8 pers-h/h
Demand Flows (Total)	1947 veh/h	2336 pers/h
Percent Heavy Vehicles (Demand)	3.0 %	
Degree of Saturation	0.865	
Practical Spare Capacity	-1.7 %	
Effective Intersection Capacity	2252 veh/h	
Control Delay (Total)	8.89 veh-h/h	10.67 pers-h/h
Control Delay (Average)	16.4 sec	16.4 sec
Control Delay (Worst Lane)	21.9 sec	
Control Delay (Worst Movement)	21.9 sec	21.9 sec
Geometric Delay (Average)	0.0 sec	
Stop-Line Delay (Average)	16.4 sec	
Idling Time (Average)	13.1 sec	
Intersection Level of Service (LOS)	LOS B	
95% Back of Queue - Vehicles (Worst Lane)	22.6 veh	
95% Back of Queue - Distance (Worst Lane)	577.9 ft	
Queue Storage Ratio (Worst Lane)	0.48	
Total Effective Stops	764 veh/h	917 pers/h
Effective Stop Rate	0.39 per veh	0.39 per pers
Proportion Queued	0.67	0.67
Performance Index	89.7	89.7
Cost (Total)	613.19 \$/h	613.19 \$/h
Fuel Consumption (Total)	53.3 gal/h	
Carbon Dioxide (Total)	478.0 kg/h	
Hydrocarbons (Total)	0.043 kg/h	
Carbon Monoxide (Total)	0.581 kg/h	
NOx (Total)	0.733 kg/h	

Site Level of Service (LOS) Method: Delay & v/c (HCM 2010). Site LOS Method is specified in the Parameter Settings dialog (Site tab).

Roundabout LOS Method: SIDRA Roundabout LOS.

Intersection LOS value for Vehicles is based on average delay for all vehicle movements.

Roundabout Capacity Model: SIDRA Standard.

HCM Delay Formula option is used. Control Delay does not include Geometric Delay since Exclude Geometric Delay option applies.

Intersection Performance - Annual Values		
Performance Measure	Vehicles	Persons
Demand Flows (Total)	934,335 veh/y	1,121,201 pers/y
Delay	4,266 veh-h/y	5,119 pers-h/y
Effective Stops	366,770 veh/y	440,124 pers/y
Travel Distance	585,973 veh-mi/y	703,167 pers-mi/y
Travel Time	20,309 veh-h/y	24,371 pers-h/y
Cost	294,330 \$/y	294,330 \$/y
Fuel Consumption	25,605 gal/y	
Carbon Dioxide	229,453 kg/y	
Hydrocarbons	21 kg/y	
Carbon Monoxide	279 kg/y	
NOx	352 kg/y	

Intersection 3: West Lilac Road/Camino Del Rey

INTERSECTION SUMMARY

Site: 1 [Ocean Breeze Ranch Project]

New Site (Scenario: Cumulative + Project Condition - PM Peak Hour (Existing Geometry))
Roundabout

Intersection Performance - Hourly Values		
Performance Measure	Vehicles	Persons
Travel Speed (Average)	31.0 mph	31.0 mph
Travel Distance (Total)	1075.9 veh-mi/h	1291.1 pers-mi/h
Travel Time (Total)	34.7 veh-h/h	41.6 pers-h/h
Demand Flows (Total)	1715 veh/h	2058 pers/h
Percent Heavy Vehicles (Demand)	3.0 %	
Degree of Saturation	0.643	
Practical Spare Capacity	32.2 %	
Effective Intersection Capacity	2668 veh/h	
Control Delay (Total)	5.29 veh-h/h	6.35 pers-h/h
Control Delay (Average)	11.1 sec	11.1 sec
Control Delay (Worst Lane)	12.5 sec	
Control Delay (Worst Movement)	12.5 sec	12.5 sec
Geometric Delay (Average)	0.0 sec	
Stop-Line Delay (Average)	11.1 sec	
Idling Time (Average)	8.4 sec	
Intersection Level of Service (LOS)	LOS B	
95% Back of Queue - Vehicles (Worst Lane)	8.0 veh	
95% Back of Queue - Distance (Worst Lane)	204.4 ft	
Queue Storage Ratio (Worst Lane)	0.17	
Total Effective Stops	594 veh/h	713 pers/h
Effective Stop Rate	0.35 per veh	0.35 per pers
Proportion Queued	0.48	0.48
Performance Index	59.8	59.8
Cost (Total)	494.17 \$/h	494.17 \$/h
Fuel Consumption (Total)	45.2 gal/h	
Carbon Dioxide (Total)	405.1 kg/h	
Hydrocarbons (Total)	0.036 kg/h	
Carbon Monoxide (Total)	0.497 kg/h	
NOx (Total)	0.626 kg/h	

Site Level of Service (LOS) Method: Delay & v/c (HCM 2010). Site LOS Method is specified in the Parameter Settings dialog (Site tab).

Roundabout LOS Method: SIDRA Roundabout LOS.

Intersection LOS value for Vehicles is based on average delay for all vehicle movements.

Roundabout Capacity Model: SIDRA Standard.

HCM Delay Formula option is used. Control Delay does not include Geometric Delay since Exclude Geometric Delay option applies.

Intersection Performance - Annual Values		
Performance Measure	Vehicles	Persons
Demand Flows (Total)	823,145 veh/y	987,774 pers/y
Delay	2,538 veh-h/y	3,046 pers-h/y
Effective Stops	285,135 veh/y	342,162 pers/y
Travel Distance	516,449 veh-mi/y	619,739 pers-mi/y
Travel Time	16,638 veh-h/y	19,966 pers-h/y
Cost	237,204 \$/y	237,204 \$/y
Fuel Consumption	21,694 gal/y	
Carbon Dioxide	194,434 kg/y	
Hydrocarbons	17 kg/y	
Carbon Monoxide	238 kg/y	
NOx	300 kg/y	

Intersection	
Intersection Delay, s/veh	16.6
Intersection LOS	C

Movement	EBL	EBT	WBT	WBR	SBL	SBR
Lane Configurations	↘	↑	↑	↗	↘	
Traffic Vol, veh/h	81	225	331	204	249	99
Future Vol, veh/h	81	225	331	204	249	99
Peak Hour Factor	0.92	0.92	0.92	0.92	0.92	0.92
Heavy Vehicles, %	2	2	2	2	2	2
Mvmt Flow	88	245	360	222	271	108
Number of Lanes	1	1	1	1	1	0

Approach	EB	WB	SB
Opposing Approach	WB	EB	
Opposing Lanes	2	2	0
Conflicting Approach Left	SB		WB
Conflicting Lanes Left	1	0	2
Conflicting Approach Right		SB	EB
Conflicting Lanes Right	0	1	2
HCM Control Delay	13.9	16.4	19.4
HCM LOS	B	C	C

Lane	EBLn1	EBLn2	WBLn1	WBLn2	SBLn1
Vol Left, %	100%	0%	0%	0%	72%
Vol Thru, %	0%	100%	100%	0%	0%
Vol Right, %	0%	0%	0%	100%	28%
Sign Control	Stop	Stop	Stop	Stop	Stop
Traffic Vol by Lane	81	225	331	204	348
LT Vol	81	0	0	0	249
Through Vol	0	225	331	0	0
RT Vol	0	0	0	204	99
Lane Flow Rate	88	245	360	222	378
Geometry Grp	7	7	7	7	2
Degree of Util (X)	0.175	0.45	0.634	0.347	0.64
Departure Headway (Hd)	7.139	6.628	6.342	5.628	6.09
Convergence, Y/N	Yes	Yes	Yes	Yes	Yes
Cap	500	540	568	636	590
Service Time	4.914	4.403	4.108	3.393	4.149
HCM Lane V/C Ratio	0.176	0.454	0.634	0.349	0.641
HCM Control Delay	11.4	14.8	19.5	11.4	19.4
HCM Lane LOS	B	B	C	B	C
HCM 95th-tile Q	0.6	2.3	4.4	1.5	4.5

Intersection	
Intersection Delay, s/veh	18
Intersection LOS	C

Movement	EBL	EBT	WBT	WBR	SBL	SBR
Lane Configurations	↖	↑	↑	↗	↖	
Traffic Vol, veh/h	66	438	327	239	176	52
Future Vol, veh/h	66	438	327	239	176	52
Peak Hour Factor	0.97	0.97	0.97	0.97	0.97	0.97
Heavy Vehicles, %	2	2	2	2	2	2
Mvmt Flow	68	452	337	246	181	54
Number of Lanes	1	1	1	1	1	0

Approach	EB	WB	SB
Opposing Approach	WB	EB	
Opposing Lanes	2	2	0
Conflicting Approach Left	SB		WB
Conflicting Lanes Left	1	0	2
Conflicting Approach Right		SB	EB
Conflicting Lanes Right	0	1	2
HCM Control Delay	24	14.3	14.2
HCM LOS	C	B	B

Lane	EBLn1	EBLn2	WBLn1	WBLn2	SBLn1
Vol Left, %	100%	0%	0%	0%	77%
Vol Thru, %	0%	100%	100%	0%	0%
Vol Right, %	0%	0%	0%	100%	23%
Sign Control	Stop	Stop	Stop	Stop	Stop
Traffic Vol by Lane	66	438	327	239	228
LT Vol	66	0	0	0	176
Through Vol	0	438	327	0	0
RT Vol	0	0	0	239	52
Lane Flow Rate	68	452	337	246	235
Geometry Grp	7	7	7	7	2
Degree of Util (X)	0.125	0.765	0.568	0.366	0.421
Departure Headway (Hd)	6.604	6.096	6.065	5.353	6.449
Convergence, Y/N	Yes	Yes	Yes	Yes	Yes
Cap	542	592	593	670	557
Service Time	4.356	3.848	3.818	3.106	4.506
HCM Lane V/C Ratio	0.125	0.764	0.568	0.367	0.422
HCM Control Delay	10.3	26.1	16.6	11.2	14.2
HCM Lane LOS	B	D	C	B	B
HCM 95th-tile Q	0.4	7	3.5	1.7	2.1

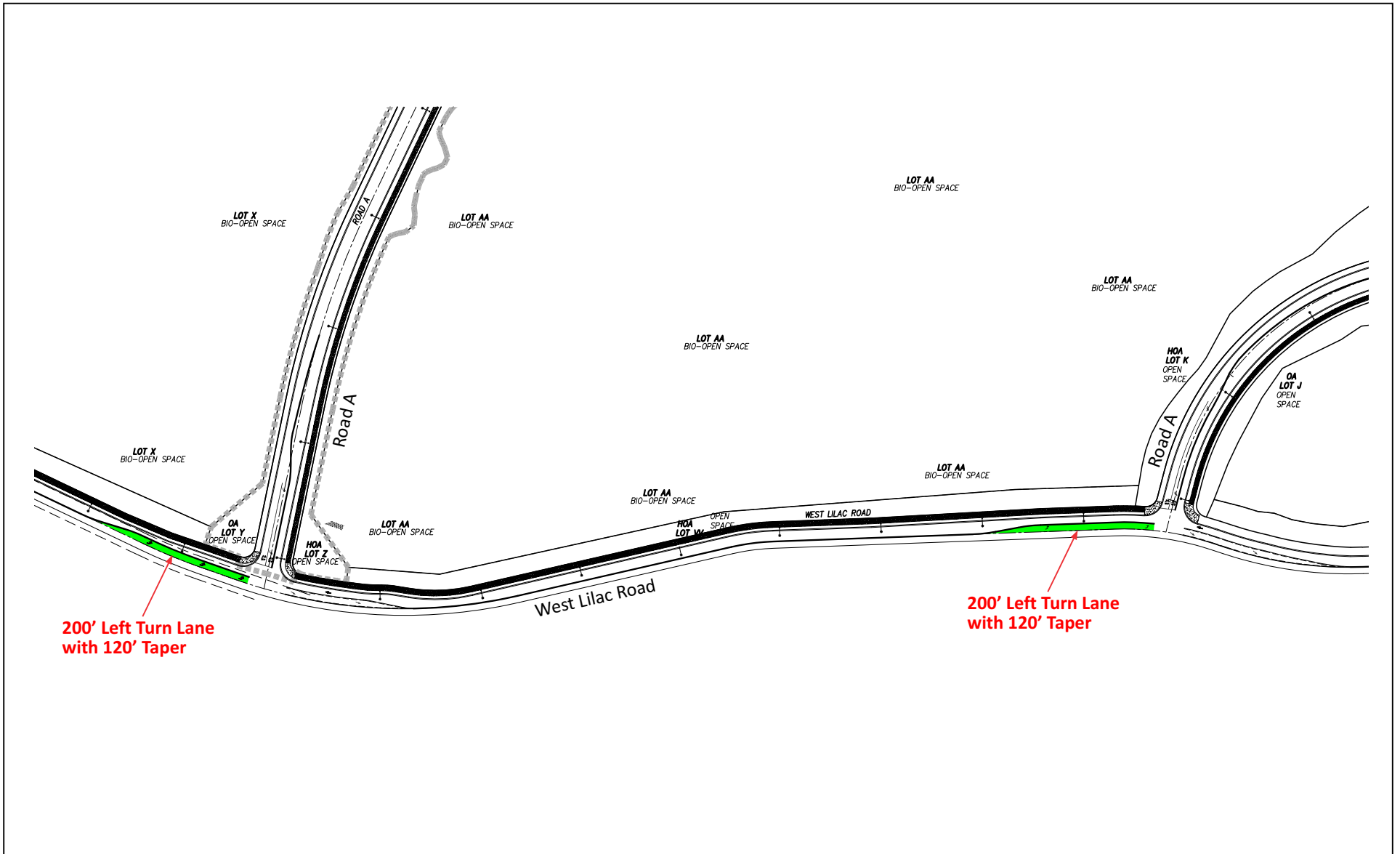

LSA



Ocean Breeze Ranch Traffic Impact Study
 West Lilac Road/Project Access Intersections
 Conceptual Striping

APPENDIX H

SIGNAL WARRANT WORKSHEETS

Figure 4C-101 (CA). Traffic Signal Warrants Worksheet (Sheet 2 of 5)

WARRANT 2 - Four Hour Vehicular Volume

SATISFIED* YES NO

Record hourly vehicular volumes for any four hours of an average day.

APPROACH LANES	One		2 or More		Hour	
Both Approaches - Major Street						
Higher Approach - Minor Street						

*All plotted points fall above the applicable curve in Figure 4C-1. (URBAN AREAS)	Yes <input type="checkbox"/>	No <input type="checkbox"/>
<u>OR</u> , All plotted points fall above the applicable curve in Figure 4C-2. (RURAL AREAS)	Yes <input type="checkbox"/>	No <input type="checkbox"/>

WARRANT 3 - Peak Hour
(Part A or Part B must be satisfied)

SATISFIED YES NO

PART A

SATISFIED YES NO

(All parts 1, 2, and 3 below must be satisfied for the same one hour, for any four consecutive 15-minute periods)

1. The total delay experienced by traffic on one minor street approach (one direction only) controlled by a STOP sign equals or exceeds four vehicle-hours for a one-lane approach, or five vehicle-hours for a two-lane approach; <u>AND</u>	Yes <input type="checkbox"/>	No <input type="checkbox"/>
2. The volume on the same minor street approach (one direction only) equals or exceeds 100 vph for one moving lane of traffic or 150 vph for two moving lanes; <u>AND</u>	Yes <input type="checkbox"/>	No <input type="checkbox"/>
3. The total entering volume serviced during the hour equals or exceeds 800 vph for intersections with four or more approaches or 650 vph for intersections with three approaches.	Yes <input type="checkbox"/>	No <input type="checkbox"/>

PART B

SATISFIED YES NO

APPROACH LANES	One		2 or More		Hour	
					A.M.	P.M.
Both Approaches - Major Street			X		1046	939
Higher Approach - Minor Street			X		258	152

The plotted point falls above the applicable curve in Figure 4C-3. (URBAN AREAS)	Yes <input type="checkbox"/>	No <input type="checkbox"/>
<u>OR</u> , The plotted point falls above the applicable curve in Figure 4C-4. (RURAL AREAS)	Yes <input checked="" type="checkbox"/>	No <input type="checkbox"/>

The satisfaction of a traffic signal warrant or warrants shall not in itself require the installation of a traffic control signal.

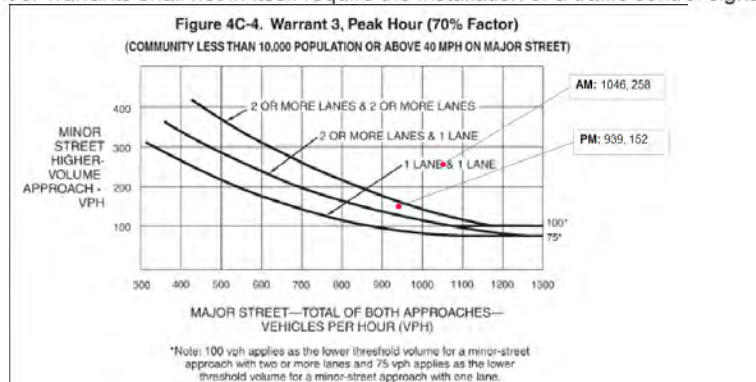
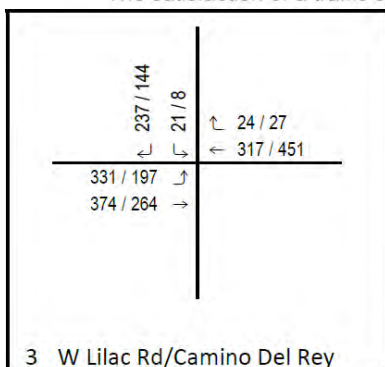

Start Date: 11/8/2018
 Start Time: 12:00:00 AM
 Site Code: 003-18811
 County of San Diego
 Old Highway 395
 B/ West Lilac Road - Via Urner Road - CSD012
 24 Hour Directional Volume Count

Time	15-Minute Volumes			Major Hourly Volumes		
	Southbound	Northbound	Total	Southbound	Northbound	Total
12:00 AM	1	9	10			
12:15 AM	1	4	5			
12:30 AM	1	2	3			
12:45 AM	2	1	3	5	16	21
01:00 AM	1	0	1	5	7	12
01:15 AM	0	3	3	4	6	10
01:30 AM	2	1	3	5	5	10
01:45 AM	0	2	2	3	6	9
02:00 AM	1	2	3	3	8	11
02:15 AM	0	0	0	3	5	8
02:30 AM	1	0	1	2	4	6
02:45 AM	1	0	1	3	2	5
03:00 AM	5	0	5	7	0	7
03:15 AM	3	1	4	10	1	11
03:30 AM	5	1	6	14	2	16
03:45 AM	4	0	4	17	2	19
04:00 AM	11	0	11	23	2	25
04:15 AM	15	2	17	35	3	38
04:30 AM	21	3	24	51	5	56
04:45 AM	28	3	31	75	8	83
05:00 AM	59	3	62	123	11	134
05:15 AM	73	10	83	181	19	200
05:30 AM	102	16	118	262	32	294
05:45 AM	150	12	162	384	41	425
06:00 AM	161	21	182	486	59	545
06:15 AM	158	21	179	571	70	641
06:30 AM	181	29	210	650	83	733
06:45 AM	182	25	207	682	96	778
07:00 AM	209	19	228	730	94	824
07:15 AM	151	30	181	723	103	826
07:30 AM	114	42	156	656	116	772
07:45 AM	80	32	112	554	123	677
08:00 AM	72	35	107	417	139	556
08:15 AM	75	30	105	341	139	480
08:30 AM	66	23	89	293	120	413
08:45 AM	63	19	82	276	107	383
09:00 AM	56	28	84	260	100	360
09:15 AM	69	28	97	254	98	352
09:30 AM	49	24	73	237	99	336
09:45 AM	46	19	65	220	99	319
10:00 AM	45	26	71	209	97	306
10:15 AM	44	19	63	184	88	272
10:30 AM	34	29	63	169	93	262
10:45 AM	36	30	66	159	104	263
11:00 AM	32	32	64	146	110	256
11:15 AM	36	22	58	138	113	251
11:30 AM	37	29	66	141	113	254
11:45 AM	24	28	52	129	111	240

Start Date: 11/8/2018
 Start Time: 12:00:00 AM
 Site Code: 003-18811
 County of San Diego
 Old Highway 395
 B/ West Lilac Road - Via Urner Road - CSD012
 24 Hour Directional Volume Count

Time	15-Minute Volumes			Major Hourly Volumes		
	Southbound	Northbound	Total	Southbound	Northbound	Total
12:00 PM	31	36	67	128	115	243
12:15 PM	28	43	71	120	136	256
12:30 PM	28	43	71	111	150	261
12:45 PM	37	34	71	124	156	280
01:00 PM	45	45	90	138	165	303
01:15 PM	39	41	80	149	163	312
01:30 PM	33	59	92	154	179	333
01:45 PM	47	48	95	164	193	357
02:00 PM	31	70	101	150	218	368
02:15 PM	26	72	98	137	249	386
02:30 PM	33	77	110	137	267	404
02:45 PM	60	69	129	150	288	438
03:00 PM	54	99	153	173	317	490
03:15 PM	43	91	134	190	336	526
03:30 PM	46	103	149	203	362	565
03:45 PM	45	83	128	188	376	564
04:00 PM	33	83	116	167	360	527
04:15 PM	35	117	152	159	386	545
04:30 PM	37	77	114	150	360	510
04:45 PM	38	67	105	143	344	487
05:00 PM	27	81	108	137	342	479
05:15 PM	25	89	114	127	314	441
05:30 PM	17	75	92	107	312	419
05:45 PM	24	80	104	93	325	418
06:00 PM	21	63	84	87	307	394
06:15 PM	15	47	62	77	265	342
06:30 PM	14	52	66	74	242	316
06:45 PM	13	29	42	63	191	254
07:00 PM	19	23	42	61	151	212
07:15 PM	17	22	39	63	126	189
07:30 PM	10	27	37	59	101	160
07:45 PM	6	12	18	52	84	136
08:00 PM	9	27	36	42	88	130
08:15 PM	6	13	19	31	79	110
08:30 PM	7	17	24	28	69	97
08:45 PM	8	21	29	30	78	108
09:00 PM	1	16	17	22	67	89
09:15 PM	5	21	26	21	75	96
09:30 PM	2	15	17	16	73	89
09:45 PM	2	11	13	10	63	73
10:00 PM	9	9	18	18	56	74
10:15 PM	5	12	17	18	47	65
10:30 PM	2	3	5	18	35	53
10:45 PM	1	10	11	17	34	51
11:00 PM	3	8	11	11	33	44
11:15 PM	4	2	6	10	23	33
11:30 PM	1	7	8	9	27	36
11:45 PM	0	3	3	8	20	28
Total	3,549	2,867	6,416			

Start Date: 11/8/2018
 Start Time: 12:00:00 AM
 Site Code: 003-18811
 County of San Diego
 West Lilac Road
 B/ Old Highway 395 - Ladera Road - CSD004
 24 Hour Directional Volume Count

Time	15-Minute Volumes			Minor Hourly Volumes		
	Westbound	Eastbound	Total	Westbound	Eastbound	Total
12:00 AM	2	0	2			
12:15 AM	1	0	1			
12:30 AM	1	0	1			
12:45 AM	0	0	0	4	0	4
01:00 AM	0	0	0	2	0	2
01:15 AM	0	0	0	1	0	1
01:30 AM	0	0	0	0	0	0
01:45 AM	0	0	0	0	0	0
02:00 AM	2	1	3	2	1	3
02:15 AM	0	0	0	2	1	3
02:30 AM	0	0	0	2	1	3
02:45 AM	0	0	0	2	1	3
03:00 AM	0	0	0	0	0	0
03:15 AM	0	0	0	0	0	0
03:30 AM	0	2	2	0	2	2
03:45 AM	0	0	0	0	2	2
04:00 AM	0	0	0	0	2	2
04:15 AM	0	3	3	0	5	5
04:30 AM	2	2	4	2	5	7
04:45 AM	2	4	6	4	9	13
05:00 AM	1	3	4	5	12	17
05:15 AM	0	4	4	5	13	18
05:30 AM	6	14	20	9	25	34
05:45 AM	8	12	20	15	33	48
06:00 AM	8	22	30	22	52	74
06:15 AM	6	15	21	28	63	91
06:30 AM	18	16	34	40	65	105
06:45 AM	18	16	34	50	69	119
07:00 AM	30	17	47	72	64	136
07:15 AM	42	20	62	108	69	177
07:30 AM	48	36	84	138	89	227
07:45 AM	66	78	144	186	151	337
08:00 AM	57	89	146	213	223	436
08:15 AM	67	70	137	238	273	511
08:30 AM	51	36	87	241	273	514
08:45 AM	23	19	42	198	214	412
09:00 AM	14	12	26	155	137	292
09:15 AM	9	12	21	97	79	176
09:30 AM	19	17	36	65	60	125
09:45 AM	14	22	36	56	63	119
10:00 AM	10	15	25	52	66	118
10:15 AM	11	11	22	54	65	119
10:30 AM	10	16	26	45	64	109
10:45 AM	16	13	29	47	55	102
11:00 AM	14	12	26	51	52	103
11:15 AM	8	12	20	48	53	101
11:30 AM	10	16	26	48	53	101
11:45 AM	13	15	28	45	55	100

Start Date: 11/8/2018
 Start Time: 12:00:00 AM
 Site Code: 003-18811
 County of San Diego
 West Lilac Road
 B/ Old Highway 395 - Ladera Road - CSD004
 24 Hour Directional Volume Count

Time	15-Minute Volumes			Minor Hourly Volumes		
	Westbound	Eastbound	Total	Westbound	Eastbound	Total
12:00 PM	15	15	30	46	58	104
12:15 PM	20	10	30	58	56	114
12:30 PM	24	20	44	72	60	132
12:45 PM	29	7	36	88	52	140
01:00 PM	24	24	48	97	61	158
01:15 PM	24	27	51	101	78	179
01:30 PM	39	12	51	116	70	186
01:45 PM	39	76	115	126	139	265
02:00 PM	38	41	79	140	156	296
02:15 PM	28	49	77	144	178	322
02:30 PM	26	24	50	131	190	321
02:45 PM	16	25	41	108	139	247
03:00 PM	14	28	42	84	126	210
03:15 PM	20	23	43	76	100	176
03:30 PM	20	24	44	70	100	170
03:45 PM	22	23	45	76	98	174
04:00 PM	17	24	41	79	94	173
04:15 PM	20	24	44	79	95	174
04:30 PM	30	20	50	89	91	180
04:45 PM	20	14	34	87	82	169
05:00 PM	29	17	46	99	75	174
05:15 PM	23	17	40	102	68	170
05:30 PM	17	31	48	89	79	168
05:45 PM	23	17	40	92	82	174
06:00 PM	14	8	22	77	73	150
06:15 PM	9	10	19	63	66	129
06:30 PM	8	6	14	54	41	95
06:45 PM	5	5	10	36	29	65
07:00 PM	8	7	15	30	28	58
07:15 PM	4	9	13	25	27	52
07:30 PM	9	2	11	26	23	49
07:45 PM	5	12	17	26	30	56
08:00 PM	4	3	7	22	26	48
08:15 PM	4	1	5	22	18	40
08:30 PM	5	1	6	18	17	35
08:45 PM	5	5	10	18	10	28
09:00 PM	6	4	10	20	11	31
09:15 PM	8	2	10	24	12	36
09:30 PM	5	3	8	24	14	38
09:45 PM	6	2	8	25	11	36
10:00 PM	4	1	5	23	8	31
10:15 PM	4	1	5	19	7	26
10:30 PM	0	0	0	14	4	18
10:45 PM	0	1	1	8	3	11
11:00 PM	0	0	0	4	2	6
11:15 PM	4	0	4	4	1	5
11:30 PM	0	1	1	4	2	6
11:45 PM	2	2	4	6	3	9
Total	1,303	1,330	2,633			

Figure 4C-101 (CA). Traffic Signal Warrants Worksheet (Sheet 1 of 5)

11
 DIST CO RTE PM

Major St: Old Highway 395
 Minor St: West Lilac Rd

COUNT DATE 11-18-18
 CALC _____ DATE _____
 CHK _____ DATE _____

Critical Approach Speed _____ mph
 Critical Approach Speed _____ mph

Speed limit or critical speed on major street traffic > 40 mph..... }
 In built up area of isolated community of < 10,000 population..... } **RURAL (R)**
 URBAN (U)

WARRANT 1 - Eight Hour Vehicular Volume SATISFIED YES NO
 (Condition A or Condition B or combination of A and B must be satisfied)

Condition A - Minimum Vehicle Volume 100% SATISFIED YES NO
 80% SATISFIED YES NO

APPROACH LANES	MINIMUM REQUIREMENTS (80% SHOWN IN BRACKETS)												
	U		R										
	1		2 or More										
Both Approaches Major Street	500 (400)	350 (280)	600 (480)	420 (336)	5:30 AM	6:30 AM	7:30 AM	8:30 AM	1:45 PM	2:45 PM	3:45 PM	4:45 PM	Hour
Highest Approach Minor Street	150 (120)	105 (84)	200 (160)	140 (112)	641	826	480	352	404	565	510	419	
					91	177	511	176	321	170	180	168	

Condition B - Interruption of Continuous Traffic 100% SATISFIED YES NO
 80% SATISFIED YES NO

APPROACH LANES	MINIMUM REQUIREMENTS (80% SHOWN IN BRACKETS)												
	U		R										
	1		2 or More										
Both Approaches Major Street	750 (600)	525 (420)	900 (720)	630 (504)									Hour
Highest Approach Minor Street	75 (60)	53 (42)	100 (80)	70 (56)									

Combination of Conditions A & B SATISFIED YES NO

REQUIREMENT	CONDITION	✓	FULFILLED
TWO CONDITIONS SATISFIED 80%	A. MINIMUM VEHICULAR VOLUME		Yes <input type="checkbox"/> No <input type="checkbox"/>
	AND, B. INTERRUPTION OF CONTINUOUS TRAFFIC		
AND, AN ADEQUATE TRIAL OF OTHER ALTERNATIVES THAT COULD CAUSE LESS DELAY AND INCONVENIENCE TO TRAFFIC HAS FAILED TO SOLVE THE TRAFFIC PROBLEMS			Yes <input type="checkbox"/> No <input type="checkbox"/>

The satisfaction of a traffic signal warrant or warrants shall not in itself require the installation of a traffic control signal.

Figure 4C-101 (CA). Traffic Signal Warrants Worksheet (Sheet 2 of 5)

WARRANT 2 - Four Hour Vehicular Volume

SATISFIED* YES NO

Record hourly vehicular volumes for any four hours of an average day

APPROACH LANES	One		2 or More		Hour			
			7:30 AM	8:30 AM	2:30 PM	4:30 PM		
Both Approaches - Major Street		<input checked="" type="checkbox"/>	826	480	404	510		
Higher Approach - Minor Street	<input checked="" type="checkbox"/>		177	511	321	180		

*All plotted points fall above the applicable curve in Figure 4C-1. (URBAN AREAS)	Yes <input type="checkbox"/>	No <input type="checkbox"/>
<u>OR</u> , All plotted points fall above the applicable curve in Figure 4C-2. (RURAL AREAS)	Yes <input checked="" type="checkbox"/>	No <input type="checkbox"/>

WARRANT 3 - Peak Hour
 (Part A or Part B must be satisfied)

SATISFIED YES NO

PART A

SATISFIED YES NO

(All parts 1, 2, and 3 below must be satisfied for the same one hour, for any four consecutive 15-minute periods)

1. The total delay experienced by traffic on one minor street approach (one direction only) controlled by a STOP sign equals or exceeds four vehicle-hours for a one-lane approach, or five vehicle-hours for a two-lane approach; <u>AND</u>	Yes <input type="checkbox"/>	No <input type="checkbox"/>
2. The volume on the same minor street approach (one direction only) equals or exceeds 100 vph for one moving lane of traffic or 150 vph for two moving lanes; <u>AND</u>	Yes <input type="checkbox"/>	No <input type="checkbox"/>
3. The total entering volume serviced during the hour equals or exceeds 800 vph for intersections with four or more approaches or 650 vph for intersections with three approaches.	Yes <input type="checkbox"/>	No <input type="checkbox"/>

PART B

SATISFIED YES NO

APPROACH LANES	One		2 or More		Hour
Both Approaches - Major Street					
Higher Approach - Minor Street					

The plotted point falls above the applicable curve in Figure 4C-3. (URBAN AREAS)	Yes <input type="checkbox"/>	No <input type="checkbox"/>
<u>OR</u> , The plotted point falls above the applicable curve in Figure 4C-4. (RURAL AREAS)	Yes <input type="checkbox"/>	No <input type="checkbox"/>

The satisfaction of a traffic signal warrant or warrants shall not in itself require the installation of a traffic control signal.

Figure 4C-2. Warrant 2, Four-Hour Vehicular Volume (70% Factor)

(COMMUNITY LESS THAN 10,000 POPULATION OR ABOVE 40 MPH ON MAJOR STREET)

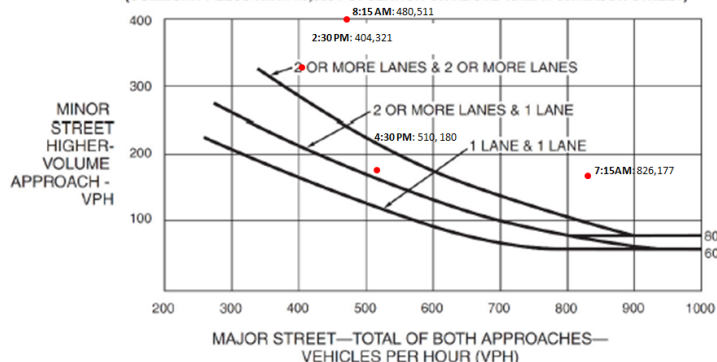

*Note: 80 vph applies as the lower threshold volume for a minor-street approach with two or more lanes and 60 vph applies as the lower threshold volume for a minor-street approach with one lane.

Figure 4C-101 (CA). Traffic Signal Warrants Worksheet (Sheet 2 of 5)

WARRANT 2 - Four Hour Vehicular Volume

SATISFIED* YES NO

Record hourly vehicular volumes for any four hours of an average day.

APPROACH LANES	One		2 or More		Hour	
Both Approaches - Major Street						
Higher Approach - Minor Street						

*All plotted points fall above the applicable curve in Figure 4C-1. (URBAN AREAS)	Yes <input type="checkbox"/>	No <input type="checkbox"/>
<u>OR</u> , All plotted points fall above the applicable curve in Figure 4C-2. (RURAL AREAS)	Yes <input type="checkbox"/>	No <input type="checkbox"/>

WARRANT 3 - Peak Hour
(Part A or Part B must be satisfied)

SATISFIED YES NO

PART A

SATISFIED YES NO

(All parts 1, 2, and 3 below must be satisfied for the same one hour, for any four consecutive 15-minute periods)

1. The total delay experienced by traffic on one minor street approach (one direction only) controlled by a STOP sign equals or exceeds four vehicle-hours for a one-lane approach, or five vehicle-hours for a two-lane approach; <u>AND</u>	Yes <input type="checkbox"/>	No <input type="checkbox"/>
2. The volume on the same minor street approach (one direction only) equals or exceeds 100 vph for one moving lane of traffic or 150 vph for two moving lanes; <u>AND</u>	Yes <input type="checkbox"/>	No <input type="checkbox"/>
3. The total entering volume serviced during the hour equals or exceeds 800 vph for intersections with four or more approaches or 650 vph for intersections with three approaches.	Yes <input type="checkbox"/>	No <input type="checkbox"/>

PART B

SATISFIED YES NO

APPROACH LANES	One		2 or More		Hour	
					A.M.	P.M.
Both Approaches - Major Street			X		864	654
Higher Approach - Minor Street	X				337	203

The plotted point falls above the applicable curve in Figure 4C-3. (URBAN AREAS)	Yes <input type="checkbox"/>	No <input type="checkbox"/>
<u>OR</u> , The plotted point falls above the applicable curve in Figure 4C-4. (RURAL AREAS)	Yes <input checked="" type="checkbox"/>	No <input type="checkbox"/>

The satisfaction of a traffic signal warrant or warrants shall not in itself require the installation of a traffic control signal.

