

BIENNIAL REPORT ON IMPACTS OF DISTRIBUTED GENERATION

Prepared in Compliance with AB 578 –
With Data through 2011 and Selected 2012 Data

California Public Utilities Commission

MAY 2013



BLACK & VEATCH
Building a world of difference.®

FINAL REPORT

BIENNIAL REPORT ON IMPACTS OF DISTRIBUTED GENERATION

Prepared in Compliance with AB 578 –
With Data through 2011 and Selected 2012 Data

B&V PROJECT NO. 176365

PREPARED FOR



California Public Utilities Commission

18 MARCH 2013

Table of Contents

1.0	Executive Summary	1-1
1.1	Introduction	1-1
1.2	Overview of Distributed Generation	1-1
1.3	Impacts of DG on the Transmission and Distribution System.....	1-4
1.4	Issues and Barriers Impacting DG Deployment	1-8
1.5	Emerging Technologies	1-8
1.6	Recommendations for Future Study	1-9
2.0	Introduction	2-1
2.1	Background	2-1
2.2	Distributed Generation Policy	2-2
2.3	Approach and Methodology	2-3
2.4	Report Organization	2-3
3.0	Distributed Generation Overview	3-1
3.1	Description of DG Technologies.....	3-1
3.2	DG Currently Installed in California	3-3
4.0	DG Impacts on the Transmission and Distribution System	4-1
4.1	Distribution System Reliability and Operation.....	4-2
4.2	Transmission System Reliability and Operation.....	4-7
4.3	Size and Location Dependent Impact of DG	4-10
4.4	Peak Demand Impact Analysis	4-12
5.0	Issues and Barriers Impacting DG Deployment	5-1
5.1	Financing and Economics	5-3
5.2	Policy and Regulatory	5-6
5.3	Grid Access and Interconnection.....	5-12
5.4	Integration	5-19
5.5	Miscellaneous	5-21
5.6	Key Issues and Barriers.....	5-24
6.0	Emerging Technologies	6-1
6.1	Smart Inverters.....	6-1
6.2	Energy Storage	6-3
6.3	Advanced Grid Management / Smart Grid Technologies	6-6
6.4	Microgrids.....	6-8
7.0	Recommendations for Future Study	7-1
Appendix A.	Installed Capacity Data	A-1
Appendix B.	Peak Demand Impact Analysis Methodology	B-1
Appendix C.	Future DG Study	C-1
Appendix D.	January 31, 2013 Report Presentation, Including Selected 2012 Data Updates	D-1

LIST OF TABLES

Table 1-1	Summary of Customer-Side DG Installed in California by Technology (All Incentive Programs) through 2011.....	1-3
Table 1-2	Key Remaining Issues and Barriers for Customer-side DG.....	1-8
Table 3-1	Description of Prevalent Customer-side DG Technologies *.....	3-2
Table 3-2	Summary of DG Program Characteristics.....	3-4
Table 3-3	Summary of Customer-Side DG Installed in California by Technology (All Incentive Programs) through 2011.....	3-6
Table 3-4	Summary of CSI Installations by Program and Utility (All Solar PV).....	3-10
Table 3-5	Summary of SGIP Installations by Technology and Utility.....	3-11
Table 3-6	Summary of ERP Installations by Technology and Utility.....	3-12
Table 3-7	Summary of NSHP Installations by Utility.....	3-12
Table 3-8	Summary of SB 1 POU Installations by Utility.....	3-13
Table 3-9	Summary of NEM DG Installations by Technology and Utility.....	3-14
Table 3-10	Summary of Non-NEM DG Installations by Technology and Utility.....	3-15
Table 3-11	Summary of FIT – AB 1969 Installations by Technology.....	3-16
Table 3-12	Summary of IOU Solar PV Program Installations by Ownership.....	3-17
Table 4-1	Peak Demand Impact by Technology.....	4-16
Table 5-1	Issues and Barriers Impacting DG Deployment.....	5-2
Table 5-2	Number of Interconnection Applications and Average Interconnection Application Processing Times for CSI PV Systems by IOU.....	5-15
Table 5-3	Key Remaining Issues and Barriers for Customer-side DG.....	5-25

LIST OF FIGURES

Figure 1-1	Goals for California's Active DG Programs	1-4
Figure 1-2	Operating DG Capacity by Program, and CAISO Demand, on September 7 th , 2011.....	1-7
Figure 3-1	Goals for California's Active DG Programs	3-5
Figure 3-2	Cumulative DG Capacity Installed by Program.....	3-7
Figure 3-3	Cumulative DG Capacity Installed by Technology.....	3-8
Figure 3-4	Cumulative Non-Solar DG Capacity Installed by Technology	3-8
Figure 4-1	Typical Electric Power System Single-Line Diagram	4-1
Figure 4-2	Sample Solar Resource Data for One Day	4-5
Figure 4-3	Solar Irradiance Variability – One Location vs. 25 Locations	4-11
Figure 4-4	Impact of Customer-Side DG on CAISO Demand on September 7 th , 2011	4-13
Figure 4-5	Operating DG Capacity by Program and CAISO Demand on September 7 th , 2011.....	4-14
Figure 4-6	Hourly DG Capacity Factors by Program and CAISO Demand on September 7 th , 2011.....	4-15
Figure 4-7	Peak Demand Impact of Solar PV on Typical SCE Residential Distribution Feeder	4-18
Figure 4-8	Peak Demand Impact of Solar PV on Typical SCE Non-Residential Distribution Feeder	4-19
Figure 5-1	Percentage of PV Systems with Third-Party Ownership in CSI, 2007-2012	5-4
Figure 5-2	Solar Module Prices from December 2001 – March 2012	5-5
Figure 5-3	PG&E Residential Rate Tier Structure (January 2012)	5-8
Figure 5-4	Example Impact of Rate Structures on SDG&E Customer Electric Bills.....	5-9
Figure 5-5	Average Interconnection Application Processing Times for CSI PV Systems by IOU	5-16
Figure 5-6	Example Interconnection Capacity Mapping Tool from PG&E	5-17
Figure 6-1	Energy Storage Discharge Time and Rated Power Graph.....	6-4
Figure 6-2	Potential Applications of Energy Storage (Black & Veatch).....	6-6
Figure 6-3	Emerging Smart Grid Infrastructure in Support of High Penetration DG PV.....	6-7
Figure 6-4	Re-sectionalization Example	6-8

LEGAL NOTICE

This report was prepared as an account of work sponsored by the California Public Utilities Commission. It does not necessarily represent the views of the Commission or any of its employees except to the extent, if any, that it has formally been approved by the Commission at a public meeting. For information regarding any such action, communicate directly with the Commission at 505 Van Ness Avenue, San Francisco, California 94102. Neither the Commission nor the State of California, nor any officer, employee, or any of its contractors or subcontractors makes any warranty, express or implied, or assumes any legal liability whatsoever for the contents of this document.

ACKNOWLEDGEMENTS

The authors of this report would like to acknowledge the significant contributions made to this report by CPUC staff (Melicia Charles, James Loewen, Hazel Miranda, Neal Reardon and Rachel Peterson), and representatives from the three investor-owned utilities (Pacific Gas and Electric, Southern California Edison, and San Diego Gas & Electric), and the California Center for Sustainable Energy.

1.0 Executive Summary

This report is prepared in response to Assembly Bill (AB) 578 (Blakeslee, 2008) which requires the California Public Utilities Commission (CPUC) to submit to the legislature a biennial report on the impacts of distributed generation (DG) on California's transmission and distribution (T&D) systems. This report is summarized in the sections below.

1.1 INTRODUCTION

The CPUC oversees distributed generation policies and programs on both the customer and utility (wholesale) side of the electric meter within the service territories of California's investor-owned utilities. This report is focused primarily on the impacts and barriers of customer-side DG, rather than wholesale distributed generation. Many impacts and barriers for wholesale DG are also prevalent for customer-side DG. Where appropriate this report discusses both customer-side and wholesale systems; however, unless indicated, "DG" refers to customer-side systems in this report.

The previous "Impact of Distributed Generation" report, prepared by Itron, Inc., was issued in January of 2010 (2010 Report). For this report, an update of DG installations resulting from various California programs is provided for customer-side DG installations through the end of 2011. Selected information in this report has been updated through the end of 2012 in Appendix D. The report also covers briefly the various new programs for wholesale generation that have been implemented since the 2010 Report.

In developing this report, Black & Veatch relied on several sources of information, including:

- Gathering and using primary data from existing incentive programs
- Interviews with utility distribution engineers and program managers of CSI and SGIP programs
- Recent CSI and SGIP reports and other published CPUC reports on DG
- General literature review of past studies on these issues

1.2 OVERVIEW OF DISTRIBUTED GENERATION

Governor Brown has established a high-level goal for California to achieve 12,000 megawatts of renewable DG by 2020. California has had a history of encouraging the development of smaller generation facilities that connected directly at the distribution level of the electricity system. DG growth has been spurred by several government-sponsored incentive programs. The California Energy Commission's Emerging Renewables Program (ERP) was funded as a result of AB 1890, and provided support to emerging renewable projects on the customer-side of the meter. The CPUC's Self-Generation Incentive Program (SGIP), which was started in response to the energy crisis in 2001, offered incentives for DG projects located at utility customer sites. The SGIP program supported a variety of distributed generation technologies including solar photovoltaic (PV), wind, fuel cells, and other conventional technologies. When the California Solar Initiative (CSI) program and several related programs began in 2007 as a result of Senate Bill (SB) 1 (Murray, 2006), with a goal of promoting 3,000 MW of distributed solar in the state, support for solar PV technologies was shifted from the SGIP program to the CSI program.

The 2010 Report addressed the installed DG in California under the SGIP and CSI programs as well as net energy metering (NEM) and non-NEM projects interconnected to the three investor-owned

utilities (IOUs) through September of 2009. Since then, new programs have been launched to promote more DG in the state; both on the customer side of the meter and on the wholesale side, and installations have increased dramatically under existing programs. Black & Veatch reviewed program data to determine the total amount of DG that has been installed. The eight customer-side programs include:

- California Solar Initiative (CSI)
 - General Market (GM)
 - Multi-family Affordable Solar Housing (MASH)
 - Single-family Affordable Solar Housing (SASH)
- SB 1 Publicly-Owned Utility (POU) Programs
- New Solar Homes Partnership (NSHP)
- Self-Generation Incentive Program (SGIP)
- Emerging Renewables Program (ERP) – no longer active as of June 2012
- Renewable Energy Self-Generation Bill Credit Transfer (RES-BCT) Program

Nearly all DG systems installed under these eight programs participate in the NEM tariff. Each IOU maintains an interconnection database that tracks DG installations on the NEM tariff and those not on the NEM tariff. Based on these databases Black & Veatch summarized the amount of DG installed throughout the state under the NEM tariff (plus non-NEM DG installations) as well as the DG installations resulting from the state’s wholesale DG programs. It should be noted that the CPUC has recently expanded the statewide virtual net metering tariff as well, although that program is not discussed in this report as the expansion of that program was not yet complete at the time this study began. The wholesale DG programs consist of¹:

- Feed-in Tariff (FIT)
 - Assembly Bill 1969 (AB 1969)
 - Senate Bill 32 (SB 32)
- Solar PV Programs (SPVP)
- Renewables Auction Mechanism (RAM)

The total customer-side DG installations through 2011 are summarized in Table 1-1 below by utility and technology. The total amount installed under the NEM tariff, in addition to non-NEM DG, is approximately 1,580 MW (this is not additive to the customer-side total noted in Table 1-1). The total amount installed under the wholesale DG programs through 2011 is 101 MW. These numbers are increasing quickly. As of the end of 2012, customer-side DG installations had reached a total of 1,785 MW, and wholesale DG installations had reached 177 MW.²

The primary focus of this report is to evaluate the impacts of customer-side DG on the transmission and distribution systems. Many impacts and barriers for wholesale DG are also prevalent for

¹ In addition to these wholesale DG programs, AB 1613 established a FIT for efficient combined heat and power (CHP) systems. SB 1122 also established a FIT for 250 MW of bioenergy, which was signed into law September 27th, 2012. SB 1122 is planned to go into effect in 2013. Neither the AB 1613 program nor the SB 1122 programs were investigated in detail in this report.

² Additional selected information for 2012 is provided in Appendix D.

customer-side DG. Where appropriate, this report discusses both customer-side and wholesale systems; however, “DG” generally refers to customer-side DG in this report.

Table 1-1 Summary of Customer-Side DG Installed in California by Technology (All Incentive Programs) through 2011

TECH-NOLOGY	PG&E		SCE		SDG&E*		SCG		POU		TOTAL	
	#	MW	#	MW	#	MW	#	MW	#	MW	#	MW
Solar PV	57,069	558	26,897	297	13,482	111	264	14	10,360	110	108,072	1,090
Wind	253	7	369	5	35	0	5	0	0	0	662	12
RF**	52	19	23	9	12	7	14	9	0	0	101	44
Non-RF***	210	79	81	33	44	24	121	75	0	0	456	211
AES	1	1	0	0	0	0	0	0	0	0	1	1
Total	57,585	663	27,370	345	13,573	142	404	98	10,360	110	109,292	1,357

This information is through 2011. Selected data has been updated through 2012 and is provided in Appendix D.

Notes:

*California Center for Sustainable Energy (CCSE) is the CSI and SGIP program administrator for SDG&E.

**Renewable Fuels (RF) includes biomass, digester gas, and landfill gas.

***Non-Renewable Fuels (Non-RF) includes natural gas, propane gas, waste gas, and any installations for which the fuel type is not specified.

AES = Advanced Energy Storage

As shown in Figure 1-1 below, the goals for California’s currently active DG programs total almost 6,000 MW, about half of the Governor’s stated goal of 12,000 MW by 2020.³ Notably, the timeframe for most of these programs is before the end of 2016. About 3,750 MW of the 6,000 MW is restricted to solar PV. About half of the total is restricted to customer-side generation only.

³ Note that additional DG outside these programs would likely be counted towards meeting the Governor’s goal, because the definition of “localized electricity generation” under the Governor’s goal may or may not fall under the definition of “DG” used in this report. Governor Brown’s goal is described at <http://www.jerrybrown.org/jobs-california%E2%80%99s-future>.

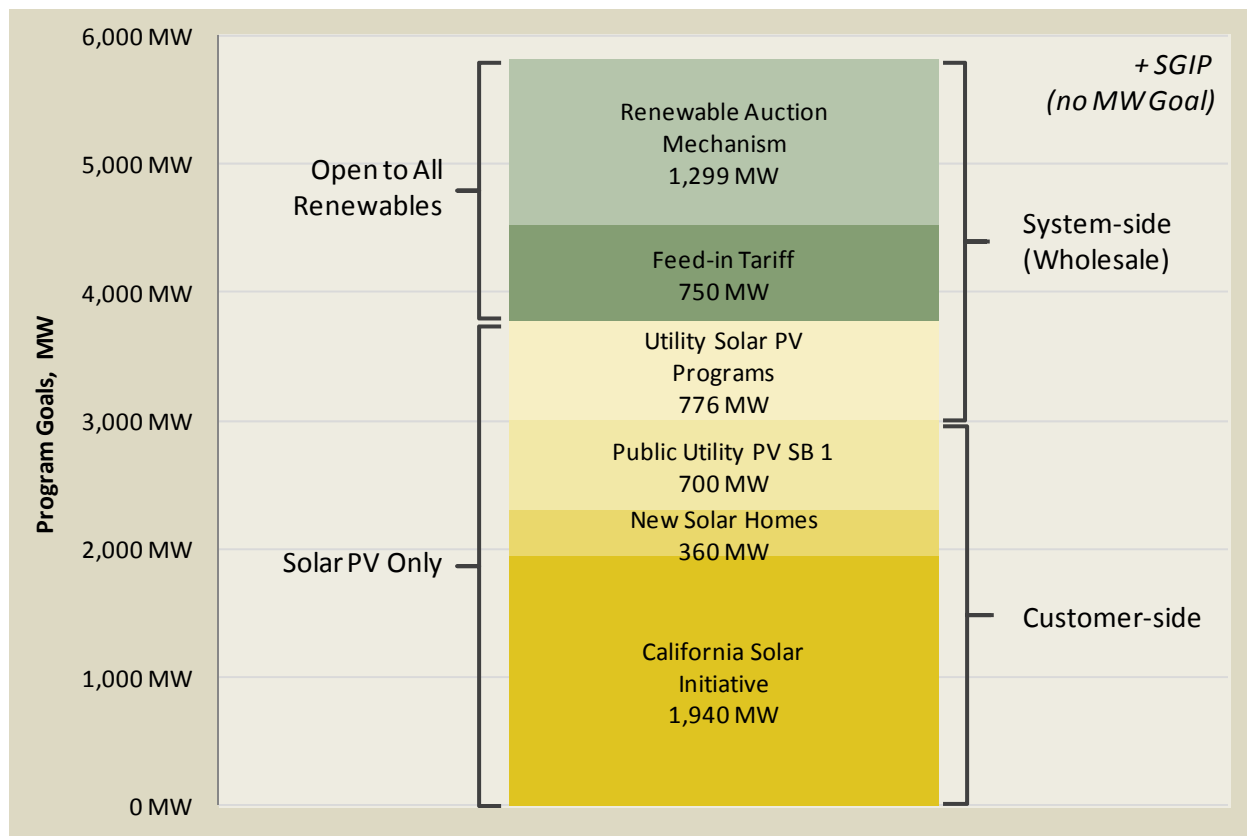

Figure 1-1 Goals for California's Active DG Programs

1.3 IMPACTS OF DG ON THE TRANSMISSION AND DISTRIBUTION SYSTEM

The impacts of DG on the distribution and transmission system today are not adequately quantified, but are believed to be relatively low. The lack of observed impacts can be attributed to several reasons:

- Currently about 90 percent of connected DG capacity is on the customer-side of the meter
- Customer-side DG systems are typically small
- The current penetration level of DG is low
- At the given penetration levels, the interconnection process and requirements have successfully mitigated impacts before they occur
- There is a general lack of monitoring DG system output⁴ and of the effects of DG systems on the grid (that is, utilities do not have the appropriate tools to systematically collect and evaluate data on problems or benefits attributable to DG).

⁴ Currently, telemetering requirements are imposed only on DG systems 1 MW or larger. Smaller units do not have this requirement since at lower penetrations the expectation was that the impacts would be minimal, the cost to collect the data would be relatively high, and processing of this additional data may not be necessary. This

For these reasons, it is difficult to quantify the impacts of customer-side DG on the grid. It is expected by many that impacts will increase as DG penetration increases. However, to be able to quantify the impacts, the utilities will need to begin systematically monitoring, evaluating, and associating such impacts with DG systems.

The expected impacts would first occur on the distribution system because of the direct connection of DG to the distribution system. However, as the penetration of DG increases, the impacts will roll up to the transmission system. What many industry observers agree on is “DG that is at the ‘right place at the right time’ will create the greatest value, while additional electricity supply in the wrong place at the wrong time could result in added costs to the system,” as stated in a report published by Rocky Mountain Institute and PG&E in March 2012.⁵ However, it is difficult to develop quantitative measuring and monitoring protocols to systematically gauge whether DG is being deployed at the right place at the right time, and there has been no effort yet in California to do so.

Impacts of DG have been split into distribution and transmission. Below is a list of impacts, both positive and negative, that DG can have on the distribution system, some of which have already been observed on IOU systems.

- Distribution system line losses
- Peak demand reduction
- Deferred distribution system upgrades
- Frequency control⁶
- Voltage regulation
- Reverse power flow
- Operational flexibility

To date, transmission system impacts due to DG installations have been small. The issues listed below are largely anticipated, although some have been observed on the IOU systems.

- Transmission system line losses
- Reverse power flow from the distribution system
- Operational procedures
- Voltage regulation
- Reliability capacity and planning

assumption should be revisited as penetration increases, or the operational requirements for DG change. For example, California utilities have recently proposed telemetering requirements for certain wholesale DG systems smaller than 1 MW that will export power to be aggregated and scheduled into CAISO’s market. As of this writing, the CPUC has not yet evaluated those proposals.

⁵ “Net Energy Metering, Zero Net Energy, and the Distributed Energy Resource Future: Adapting Electric Utility Business Models for the 21st Century,” Rocky Mountain Institute, Snowmass, CO, March 2012.

⁶ It should be noted that the frequency of the distribution system and transmission system is the same, and therefore impacts to frequency on the distribution system similarly affect the transmission system. For simplicity, the frequency control impact is listed and discussed under distribution system impacts here.

- Capacity margin
- System stability

Size and Location Impacts

The size and location of DG systems in relation to the distribution system dictates their impact on the grid. Though each distribution circuit is different in its capacity to accommodate DG, in most cases a larger number of small DG systems spread over a wide area will have less negative impact than a smaller number of large DG systems concentrated in a single area. This is especially true for variable resources like solar PV and wind, whose variability is “smoothed out” to some extent when aggregating the output of many generators over wide geographic areas.

Peak Demand Impacts

In addition to examining the impacts of DG on the transmission and distribution systems, Black & Veatch analyzed the impact of DG on CAISO peak demand. In estimating the impact of the total amount of installed DG capacity operating on the CAISO grid during the 2011 peak demand period, two separate approaches were taken for solar PV and non-solar installations. To determine the impact of solar PV capacity during the system peak demand, Black & Veatch used metered data from a large sampling of solar PV systems. For non-solar technologies, Black & Veatch used data from the “CPUC Self-Generation Incentive Program Eleventh-Year Impact Evaluation” prepared by Itron in June 2012.

The total amount of DG operating during the CAISO peak demand day (September 7th, 2011) is displayed in Figure 1-2, along with CAISO load. During the peak demand hour of 4-5pm, 342 MW of DG were operating, accounting for 0.7 percent of CAISO load. Operating DG peaked during the noon hour (12-1pm) at 728 MW, accounting for 1.8 percent of CAISO load at that time. Overall, the impact of DG on CAISO peak load is small, and DG solar PV peaks much earlier in the day than CAISO demand. According to Black & Veatch estimates, DG solar PV achieves an hourly capacity factor of 0.25 (out of 1) during the CAISO peak demand hour, versus 0 to 0.84 for other DG technologies. “Hourly capacity factor” refers to a generator’s output in a particular hour relative to its nameplate capacity; an hourly capacity factor of 0.25 means that DG solar PV in that hour was producing about a quarter of its nameplate capacity.

Black & Veatch acknowledges that there are limitations to only estimating the impact of DG on CAISO peak demand. CAISO and each IOU has to plan for peak demand at a variety of levels (customer transformer, distribution feeder, distribution substation, subtransmission network, transmission substation, transmission line, the utility system, and the entire CAISO system) and this report does not attempt to model the impact of DG at every level—although that may be a useful exercise. Rather, this report seeks to show the magnitude of DG output relative to the total CAISO load because this gives a general sense of how much DG is installed statewide. Future studies should conduct analysis of DG’s peak demand impact at other levels because the impact is likely to be different at lower levels than at the CAISO level.

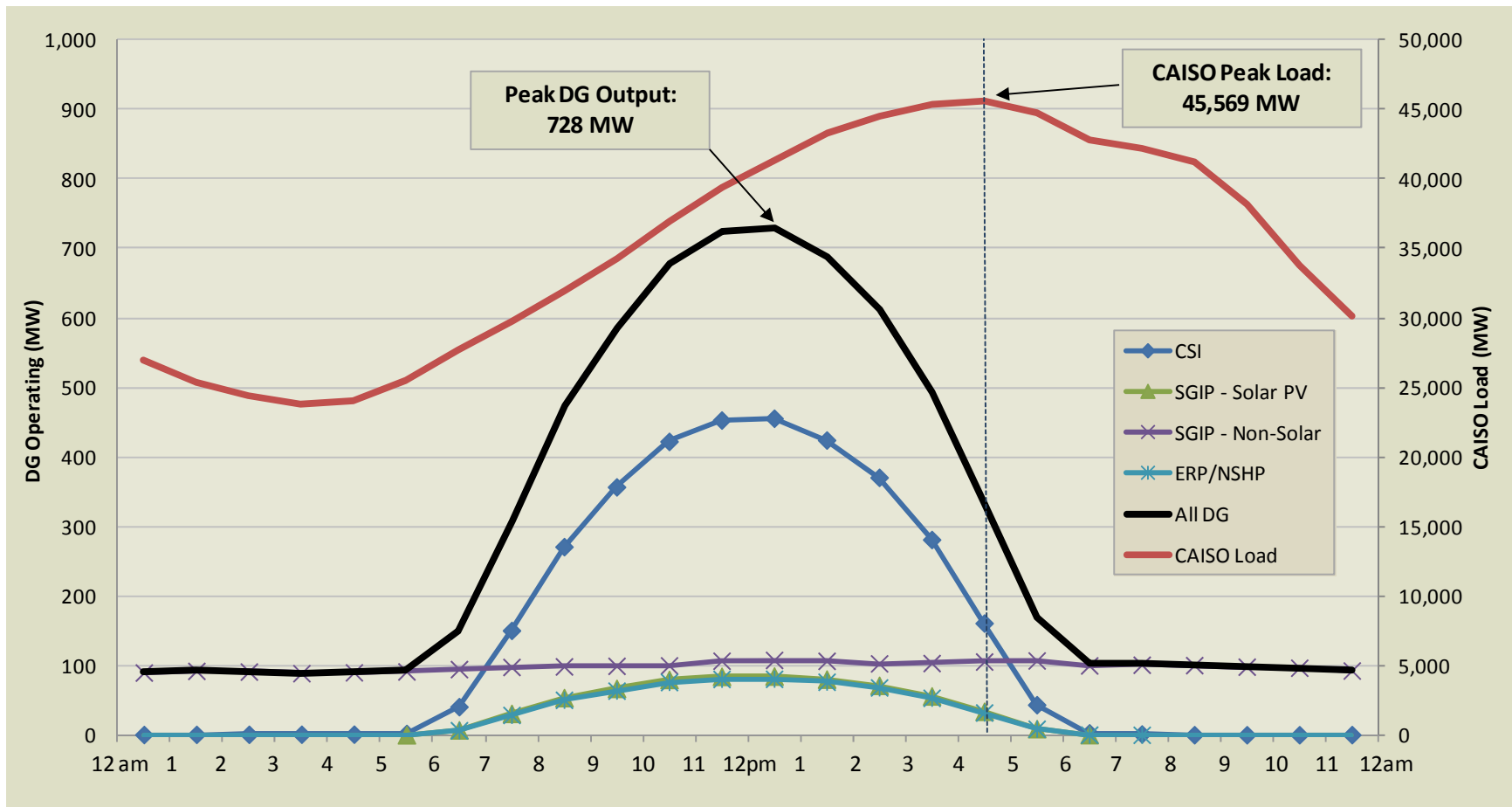

Figure 1-2 Operating DG Capacity by Program, and CAISO Demand, on September 7th, 2011

1.4 ISSUES AND BARRIERS IMPACTING DG DEPLOYMENT

The rate of DG installations in California, in particular solar PV, has increased significantly over the past several years. This increase can largely be attributed to incentives, the availability of new leasing and financing options, the decline in solar PV costs, and increased marketing efforts. In many respects, California has led the nation in identifying and removing barriers to DG deployment. Initiatives such as implementation of NEM, reform of Rule 21, and completion of online tools for rebate processing have allowed California to successfully advance the largest DG market in the U.S. Despite this success, there are still barriers to additional deployment of DG from the utility's perspective, as well as the customer and/or developer's perspective.

Black & Veatch provides an updated discussion of DG barriers in this report. Numerous issues may limit the deployment of DG, but many have been at least partially resolved, leaving some with more impact than others. The key remaining issues and barriers identified in this report are listed below.

Table 1-2 Key Remaining Issues and Barriers for Customer-side DG

<p>Financing and Economics</p> <ul style="list-style-type: none"> • Equipment and soft costs of DG are high compared to grid electricity. • Availability of government and utility financial incentives is becoming more limited because funds for incentive programs are declining.
<p>Policy and Regulatory</p> <ul style="list-style-type: none"> • Public resistance to DG could develop if non-DG customers are excessively burdened with costs to subsidize NEM DG customers. • There is a lack of incentives to locate DG in areas with the greatest benefit to the grid; need to adopt a more targeted approach.
<p>Integration</p> <ul style="list-style-type: none"> • Lack of monitoring, forecasting and control capabilities limits the utilities' ability to manage DG integration into the distribution system, and ability to rely on DG capacity. • Lack of capabilities integrating DG (especially solar PV) with distribution and transmission models. This affects the utilities' abilities to accurately simulate and plan for DG. • Distribution system design is not intended for injection of generation leading to voltage issues, reverse power flow, etc. This issue will become more widespread as DG penetration increases. • Inverter standards may need to be changed to allow better support of the grid.
<p>Miscellaneous</p> <ul style="list-style-type: none"> • Processing times and administrative delays for incentive applications and interconnection applications reduce the speed at which DG can be deployed. • Lack of suitable project sites prevents the majority of utility customers from installing DG on their own property.

1.5 EMERGING TECHNOLOGIES

Much research and development is being done on emerging technologies which may alleviate some of the negative impacts of DG systems and some of the barriers to greater DG deployment. These technologies may emerge within the next 1 to 3 years or the next 5 to 10 years. However, given the rapid pace of DG deployment in California, it is reasonable to proactively demonstrate and deploy emerging technologies with the greatest potential benefits.

This report focuses on emerging technologies that would primarily benefit PV, the largest source of DG in California. These technologies are described in the list below:

- **Smart Inverters** – Smart inverters can be equipped with functions that alleviate impacts to the grid. For example, requiring low voltage ride through function for inverters would prevent PV systems from tripping too quickly and aggravating system disturbances.
- **Energy Storage** – The intermittency of renewable DG technologies is a challenge in terms of integrating the systems to the grid. Energy storage technologies can alleviate some of the intermittency of these systems.
- **Advanced Grid Management / Smart Grid Technologies** – A variety of smart grid technologies can provide utilities with more visibility and control within the distribution system. The major utilities in the state have been making large investments in smart grid technologies that could help ease DG integration issues.
- **Microgrids** – A microgrid is a small power system that incorporates self-generation, distribution, sensors, energy storage, and energy management software with a synchronized, but separable, connection to a utility power system. It can enable DG integration through better grid monitoring and control systems, coordination with other distributed energy resources like energy storage, and more active demand management.
- **Other** – There are several other technologies that are emerging related to reducing the impacts and enhancing the benefits of DG. These include Advanced Modeling, Advanced Distribution Management Systems, Advanced Volt VAr Control. There are many other technologies as well.

1.6 RECOMMENDATIONS FOR FUTURE STUDY

DG deployment on the California system has been increasing over the past several years. With this increase, there are several unknowns. There is much to be gained from a more detailed investigation of the current and future impacts and benefits of DG on the electric grid of the IOUs in California. This type of investigation would address the following questions:

- How is DG affecting the distribution system currently, and how will this change in the future?
- How much more DG could be deployed on the system with minimal impacts and enhanced benefits?
- What additional tools are needed to identify optimal location, type, and timing of DG?
- How can an enhanced understanding of the costs of different impacts, benefits and solutions help inform effective policy to enable the deployment of more DG?
- How could the deployment of more DG be beneficial? If deployed ineffectively, how could it be deleterious?

Answering these questions can help create a clear roadmap of the growth potential of DG, and to enable California to anticipate potential challenges to DG deployment. Such an analysis should study the five primary sections listed and described below:

- 1) Existing Conditions
- 2) Impacts and Costs of DG

- 3) Potential Benefits of DG
- 4) Solutions
- 5) Scenario Analyses

The analysis should focus on the status, impacts, costs, and benefits of DG on the distribution system, as well as the transmission system, and should be a technical and quantitative analysis.

In addition to the above described analysis, the following areas should also be studied:

- Reporting issues: review NEM installation data and compare against incentive program databases
- Amount of DG (PV and non-PV) penetration if incentives and subsidies are not sustained and what other mechanisms can help sustain the market
- Development of user-friendly models to assist utilities in modeling transmission, distribution, substation and feeder level impacts with increased DG penetration. This should include transient and dynamic modeling of DG systems
- Use of a consistent approach to distribution modeling and monitoring across utilities specifically targeted to assess distribution grid operational impacts of DG systems

2.0 Introduction

This report is prepared in response to California Assembly Bill (AB) 578 (Blakeslee, 2008) which requires the California Public Utilities Commission (CPUC) to submit to the Legislature a biennial report on the impacts of distributed generation (DG) on California's transmission and distribution (T&D) systems.

On January 1, 2009, Section 321.7 of the Public Utilities Code was created requiring the CPUC to do the following:

321.7. (a) On or before January 1, 2010, and biennially thereafter, the commission, in consultation with the Independent System Operator and the State Energy Resources Conservation and Development Commission, shall study, and submit a report to the Legislature and the Governor, on the impacts of distributed energy generation on the state's distribution and transmission grid. The study shall evaluate all of the following:

(1) Reliability and transmission issues related to connecting distributed energy generation to the local distribution networks and regional grid.

(2) Issues related to grid reliability and operation, including interconnection, and the position of federal and state regulators toward distributed energy accessibility.

(3) The effect on overall grid operation of various distributed energy generation sources.

(4) Barriers affecting the connection of distributed energy to the state's grid.

(5) Emerging technologies related to distributed energy generation interconnection.

(6) Interconnection issues that may arise for the Independent System Operator and local distribution companies.

(7) The effect on peak demand for electricity.

The topics covered in this report addresses the study areas highlighted in the legislation related to distributed generation and the issues, barriers and impacts associated with their increased penetration in California.

2.1 BACKGROUND

This report is the second report prepared in response to AB 578. The previous "Impact of Distributed Generation" report, prepared by Itron, Inc., was issued in January of 2010 ("2010 Report").⁷ The 2010 Report provided background on DG in California, including broad definitions of DG and a short history of DG in California as well as the installed DG capacity through September of 2009.

The 2010 Report provided several definitions for distributed generation, including the following:

DG facilities are most frequently defined as non-centralized electricity power production facilities less than 20 MW interconnected at the distribution side of the electricity system. DG

⁷ Itron, "Impacts of Distributed Generation," Prepared for: California Public Utilities Commission Energy Division Staff, Davis, California, January 2010.

technologies include solar, wind and water-powered energy systems; and renewable and fossil-fueled internal combustion (IC) engines, small gas turbines, micro-turbines and fuel cells.⁸

For this report, DG is similarly defined, but with a special focus on smaller DG on the customer side of the meter. The CPUC regulates distributed generation policies and programs on both the customer and utility (wholesale) side of the electric meter. This report is focused primarily on the impacts and barriers of customer-side DG, rather than wholesale distributed generation. Many impacts and barriers for wholesale DG are also prevalent for customer-side DG. Where appropriate, this report discusses both customer-side and wholesale systems; however, “DG” generally refers to customer-side DG in this report.

This report also provides an update of customer-side DG installations resulting from various California programs through the end of 2011. Selected information in this report has been updated through the end of 2012 in Appendix D. The report also covers briefly the various new programs described above for wholesale generation that have been implemented since the 2010 Report. For a more general background on DG, including its history in California, readers should refer to the 2010 Report.

2.2 DISTRIBUTED GENERATION POLICY

Governor Brown has established a high-level goal for California to achieve 12,000 MW of renewable DG by 2020. While this goal has not been specifically prescribed in law, California has enacted several new laws and implemented new rules to promote additional DG since the issuance of the 2010 Report:

- Assembly Bill (AB) 1969 (Yee, Stats. 2006, ch. 731) created California’s Feed-in-Tariff (FIT) program, authorizing the purchase of up to 480 MW of renewable generating capacity from renewable facilities smaller than 1.5 MW. Subsequent legislation, SB 32 (Negrete McLeod, 2009) and SB 2 (1X) (Simitian, 2011), increased the eligible project size to 3.0 MW, and state-wide total procurement for investor-owned utilities (IOUs) and public owned utilities (POUs) to 750 MW.
- For DG projects from 3 to 20 MW, the CPUC adopted D.10-12-048, which initially authorized the IOUs to procure 1,000 MW (recently expanded to 1,299 MW by D.12-02-035 and D.12-02-002) through the Renewable Auction Mechanism (RAM) program by holding periodic auctions to procure renewable energy. The first RAM auction took place November 15, 2011.
- In addition to these programs, in 2009/2010, the CPUC also authorized Utility Solar PV Programs for each of the IOUs to own and operate solar PV facilities as well as to execute solar PV power purchase agreements with independent power producers (IPP) through a competitive solicitation process. In total, these programs have a goal to bring on up to 1,100 MW of new solar PV capacity in California.
- Electric Rule 21 is the CPUC-jurisdictional interconnection tariff. Rule 21 describes the interconnection, operating and metering requirements for generation facilities to be connected to and operate in parallel with a utility’s distribution system. The CPUC opened a rulemaking to implement improvements to the Rule 21 interconnection process in September 2011, and at the same time launched a major settlement process to accomplish a

⁸ Itron, “Impacts of Distributed Generation,” Prepared for: California Public Utilities Commission Energy Division Staff, Davis, California, January 2010.

set of global reforms to the tariff.⁹ The CPUC prioritized reforms enhancing Rule 21 for DG projects interconnecting on the utility side of the meter, in order to support the CPUC's newer wholesale DG programs. On March 16, 2012, fourteen parties to the settlement negotiations filed a settlement in CPUC Rulemaking (R.)11-09-011 that contained a significantly reformed Rule 21 tariff. The settlement was approved by the CPUC in September 2012.¹⁰ As a result, Rule 21 now provides transparent rules for a clear, predictable path to interconnection for all forms of distributed generation while maintaining the safety and reliability of the electric grid.

- The CPUC also convened Renewable Distributed Energy Collaborative (ReDEC) workshops to study the issues and impacts of system-side renewable distributed generation that is dispersed throughout the grid and interconnected for export to the utility. Two workshops have been held and the CPUC may hold additional meetings in the future.

2.3 APPROACH AND METHODOLOGY

In developing this report, Black & Veatch relied on several sources of information, including:

- Gathering and using primary data from existing incentive programs
- Interviews with utility distribution engineers and program managers of CSI and SGIP programs
- Recent CSI and SGIP reports and other published CPUC reports on DG
- General literature review of past studies on these issues

In assessing the issues and impacts to the existing transmission and distribution system as well as determining barriers, utility program managers and distribution engineers were interviewed to gather information regarding actual issues experienced by customers, installers, and the utilities. This approach provided a gauge for the degree of impact these DG issues have or may have in the future on the transmission and distribution system.

Black & Veatch also used system output data to model the impact on 2011 peak from DG installed on the California grid.

2.4 REPORT ORGANIZATION

The report is organized as follows:

- **Section 3 – Distributed Generation Overview:** Provides an overview of distributed generation technologies and the total installed capacity in the state resulting from various customer-side and wholesale DG programs. The information used is the latest available as of August 2012, with many data sets updated only through the end of 2011. Selected information in this report has been updated through the end of 2012 in Appendix D.
- **Section 4 – DG Impacts on the Transmission and Distribution System:** Highlights potential impacts of connecting distributed energy generation to the local distribution

⁹ R. 11-09-011, *Order Instituting Rulemaking on the Commission's Own Motion to Improve Distribution Level Interconnection Rules and Regulations for Certain Classes of Electric Generators and Electric Storage Resources*, filed September 22, 2011.

¹⁰ D.12-09-018, *Decision Adopting Settlement Agreement Revising Distribution Level Interconnection Rules and Regulations – Electric Tariff Rule 21 and Granting Motions to Adopt the Utilities' Rule 21 Transition Plans*, adopted September 13, 2012, in R. 11-09-011; see also www.cpuc.ca.gov/PUC/energy/procurement/LTPP/rule21.htm.

networks and regional grid. This section also discusses DG in the context of 2011 California peak demand.

- **Section 5 – Issues and Barriers Impacting DG Deployment:** Identifies key issues and barriers affecting DG deployment in the state.
- **Section 6 – Emerging Technologies:** Describes key technology advances that may help address some of the technical issues associated with DG on the grid.
- **Section 7 – Recommendations for Future Study:** Recommendations for a future study to better quantify impacts and address some of the issues and barriers identified in the report.

3.0 Distributed Generation Overview

California has had a long history of encouraging the development of smaller generation facilities that connected directly at the distribution level of the electricity system. DG growth has been spurred by several government-sponsored incentive programs. The California Energy Commission's Emerging Renewables Program (ERP) was funded as a result of AB 1890 (Brulte, 1996), and provided support to emerging renewable projects on the customer-side of the meter. The CPUC's Self-Generation Incentive Program (SGIP) started in response to the 2001 energy crisis and offers incentives for DG projects located at utility customer sites. The SGIP program supported a variety of distributed generation technologies including solar photovoltaic (PV), wind, fuel cells, and other conventional technologies. In 2007, support for solar PV technologies was shifted from the SGIP program to the CSI program as a result of SB 1, with a goal of promoting 3,000 MW of distributed solar in the state through the CSI programs (General Market, MASH, SASH), the New Solar Homes Partnership, and the SB 1 POU programs.

In addition to these customer-side programs, there have been a number of other programs initiated to support wholesale distributed generation in the state, in part to help the state meet its Renewable Portfolio Standard (RPS) goals. This section provides an overview of the current DG technologies and installations in the state.

3.1 DESCRIPTION OF DG TECHNOLOGIES

A number of DG technologies have been promoted through various incentive programs offered by the state. These include solar PV, wind, fuel cells, advanced energy storage and other conventional technologies. These technologies are described in the table below.

Table 3-1 Description of Prevalent Customer-side DG Technologies *

TECHNOLOGY	DESCRIPTION
Solar PV	Solar PV, which converts sunlight directly to electricity, has been the most widely adopted DG technology in California to date. While it does not produce any emissions and can be sited virtually anywhere in the state, the production of electricity depends on when the sun is shining. This variability in output may pose challenges for T&D grid operation as solar PV penetration continues to rise.
Wind Turbines	As with solar PV, wind turbines convert wind power to electricity only when the wind reaches a certain speed. Thus, wind turbine generation is also variable or intermittent in nature. Installations of DG-scale wind in California have been limited. Wind farms are typically comprised of larger, utility-scale turbines and are connected directly to the transmission system rather than the distribution system.
Fuel Cells (FC)	Fuel cell technology can be utilized as a constant or variable power generation resource. Fuel cells convert hydrogen-rich fuel sources directly to electricity through an electrochemical reaction with very low emissions. Most fuel cell installations generate less than 1 MW. Commercial fuel cell plants are typically fueled by natural gas, which is converted to hydrogen gas in a reformer. However, if available, hydrogen, biogas, or other fuels can be used. Natural gas is now at relatively low prices, which may cause increased interest in fuel cells fueled by natural gas.
Reciprocating Internal Combustion Engines (IC)	Reciprocating engines are the industry standard for biogas combined heat and power (CHP) projects. The output of these plants is controllable and can therefore be ramped up or down as needed, with natural gas as an alternative or backup fuel. The engine configuration is designed to handle a wide range of gas flows; the engine output can be turned down significantly without losing a considerable amount of efficiency. Internal combustion engines are by far the most common generating technology choice at biogas facilities; about 75 percent of the landfills that generate electricity use internal combustion engines.
Microturbines (MT) and Gas Turbines (GT)	Microturbines and gas turbines are frequently used for larger DG installations throughout California. Their output is not intermittent like solar PV and wind, which makes integration of these technologies technically easier. Microturbines can utilize natural gas or biogas by compressing and burning with air in the combustor, generating heat that causes the gases to expand. The expanding gases drive the turbine, which in turn drives a generator producing electricity. Heat from the turbine exhaust is recovered in the recuperator and is used to preheat incoming combustion air. This helps improve the overall efficiency of the unit. Microturbines are typically rated at less than 250 kW, but multiple units can be installed in parallel for higher capacity. Because of size limitations, microturbine units can be attractive for small to medium sized plants.
Advanced Energy Storage (AES)	Energy storage technologies convert and store electricity, increasing the value of power by allowing better utilization of off-peak generation and the mitigation of power fluctuations from intermittent renewable energy generation. Different types of technologies are available that provide a variety of storage durations. Storage durations range from microseconds (superconducting magnets, flywheels, and batteries), to minutes (flywheels and batteries), to hours and seasonal storage (pumped hydroelectric, batteries, and compressed air). The usage throughout California is limited, driven by the emerging technology, higher cost, and limited incentives. A current constraint on AES deployment is the difficulty of monetizing its benefits to the electric power system.

*** This table includes technologies that are part of customer-side programs in CA. Other energy technologies exist that can be applied in distributed applications, such as small hydro, solid biomass, and geothermal; however, these are not the focus of this report.**

3.2 DG CURRENTLY INSTALLED IN CALIFORNIA

The 2010 Report addressed the installed DG in California under the SGIP and CSI programs as well as net energy metering (NEM) and non-NEM projects interconnected to the three investor-owned utilities (IOUs) through September of 2009. Since then, new programs have been launched to promote more DG in the state, on both the customer side and utility side of the meter, and installations have increased under existing programs. Black & Veatch reviewed program data from these programs initiated in the state to determine the total amount of DG that has been installed. The eight customer-side programs include:

- California Solar Initiative (CSI)
 - General Market (GM)
 - Multi-family Affordable Solar Housing (MASH)
 - Single-family Affordable Solar Housing (SASH)
- Senate Bill 1 (SB 1) Publicly-Owned Utility (POU) Programs
- New Solar Homes Partnership (NSHP)
- Self-Generation Incentive Program (SGIP)
- Emerging Renewables Program (ERP) – no longer active as of June 2012
- Renewable Energy Self-Generation Bill Credit Transfer (RES-BCT) Program

Many DG systems installed under these eight programs participate in the NEM tariff. Each IOU maintains an interconnection database that tracks DG installations on the NEM tariff and those not on the NEM tariff. Based on these databases, Black & Veatch summarized the amount of DG installed throughout the state under the NEM tariff (plus non-NEM DG installations) as well as the DG installations resulting from the state’s wholesale DG programs. The wholesale DG programs consist of¹¹:

- Feed-in Tariff (FIT)
 - Assembly Bill 1969 (AB 1969)
 - Senate Bill 32 (SB 32)
- Utility Solar PV Programs (SPVP)
- Renewables Auction Mechanism (RAM)

Table 3-2 below summarizes the basic characteristics of each DG program. Each program is described in more detail in sections 3.2.1, 3.2.2 and 3.2.3.

¹¹ In addition to these wholesale DG programs, AB 1613 established a FIT for efficient combined heat and power (CHP) systems. SB 1122 also established a FIT for 250 MW of bioenergy, which was signed into law September 27th, 2012. SB 1122 is planned to go into effect in 2013. Neither the AB 1613 program nor the SB 1122 programs were investigated in detail in this report.

Table 3-2 Summary of DG Program Characteristics

PROGRAM	YEAR INITIATED	ELIGIBLE TECHNOLOGIES	ELIGIBLE SYSTEM SIZES	PROGRAM GOAL (MW)	CUSTOMER TYPES
Net Energy Metering	1995	Solar PV, Wind, FC	1 kW – 1 MW	No specific goal	All Types of IOU Customers
Emerging Renewables Program	1998 (ended in 2012)	Wind, FC (included Solar PV until 2007)	Up to 30 kW	No specific goal	All Types of IOU Customers
Self Generation Incentive Program	2001	Wind, FC, MT, GT, IC, AES, pressure reduction turbines, bottoming cycles (included PV until 2007)	Up to 100% of customer's annual consumption	No specific goal	All Types of IOU Customers
CSI – General Market	2007	Solar PV	1 kW – 1 MW	1,940 MW by 2016 (5% of budget allocated to MASH and 5% allocated to SASH)	All Types of IOU Customers
CSI – Multi-family Affordable Solar Housing	2007	Solar PV	1 kW – 1 MW		Low-income Multi-family Housing
CSI – Single-family Affordable Solar Housing	2007	Solar PV	1 kW – 1 MW		Low-income Single-family Housing
New Solar Homes Partnership	2007	Solar PV	1 kW – 1 MW	360 MW by 2016	New Residential Housing
SB 1 POU	2007	Solar PV	1 kW – 1 MW	700 MW by 2016	All Types of POU Customers
Feed-in Tariff - AB 1969, SB 380, SB 32	2006-2009	Solar PV, Wind, Biomass, Biogas, Small Hydro	Up to 3 MW	750 MW	IPPs – Wholesale Side
Utility Solar PV Programs	2010	Solar PV	Varies by utility from 0.5 MW to 20 MW	776 MW	IPPs and utilities – Wholesale Side
Renewable Auction Mechanism	2011	Solar PV, Wind, Biomass, Biogas, Small Hydro	3 – 20 MW	1,299 MW	IPPs – Wholesale Side

Notes:

FC = Fuel Cells; MT = Microturbines; GT = Gas Turbines; IC = Internal Combustion Engines; AES = Advanced Energy Storage

As shown in Figure 3-1, the goals for California’s currently active renewable DG programs total almost 6,000 MW, about half of the Governor’s stated goal of 12,000 MW by 2020.¹² Notably, the timeframe for most of these programs is before the end of 2016. About 3,750 MW of the 6,000 MW is restricted to solar PV. About half of the total is restricted to customer-side generation only. By comparison, the current DG program goals are well above the combined capacity of California’s nuclear plants, about 4,400 MW. (It should be noted, though, that these nuclear plants are baseload resources with high capacity factors, while DG solar PV systems are variable resources with lower capacity factors.)

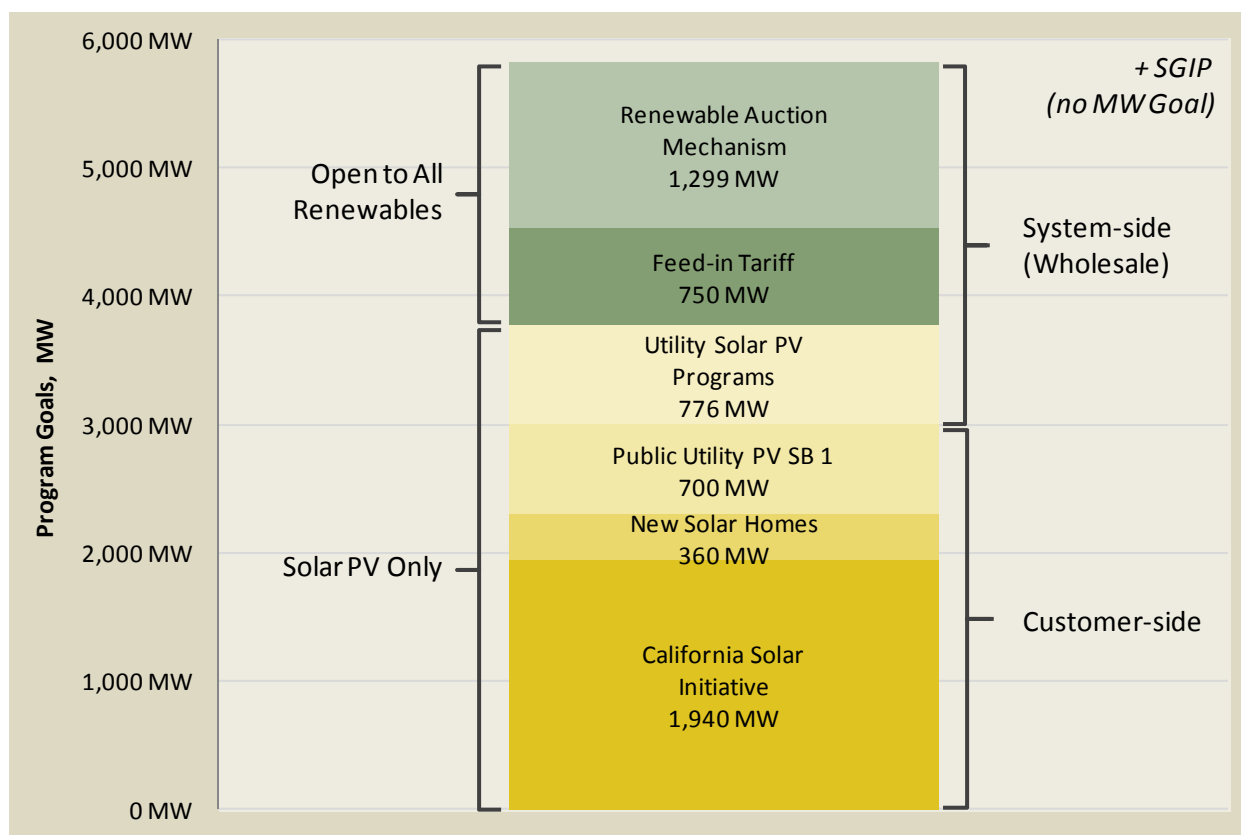

Figure 3-1 Goals for California's Active DG Programs

The total customer-side DG installations through 2011 are summarized in Table 3-3 by utility and technology.¹³ Specific data sources included the CSI Working Data Set, CPUC and California Energy

¹² Note that additional DG outside these programs would likely be counted towards meeting the Governor’s goal. The Governor’s goal calls for 12,000 new MW of localized electricity generation, sited at customer loads or close to where energy is consumed so that new transmission lines are not required and environmental impacts are minimized. “Localized electricity generation” counted under the Governor’s goal may or may not fall under the same definition as “DG” included in this report. Governor Brown’s goal is described at <http://www.jerrybrown.org/jobs-california%E2%80%99s-future>.

¹³ In this table and all others below, “#” refers to the number of individual DG installations, and “MW” refers to the combined installed capacity in ac for all DG installations in that category reported in megawatts. The tables report installations under each of the following utilities: Pacific Gas & Electric (PG&E), Southern California Edison (SCE), Southern California Gas (SCG), San Diego Gas & Electric (SDG&E), and Publicly-Owned Utilities (POU). California

Commission (CEC) program databases, SB1 POU reports, and CPUC interconnection data requests. The installed capacity (AC-rating) presented herein reflects total DG projects installed through the end of 2011, excluding qualified facilities (QFs).¹⁴ The methodology in determining the total installed capacity is described in more detail in Appendix A.

Table 3-3 Summary of Customer-Side DG Installed in California by Technology (All Incentive Programs) through 2011

TECH-NOLOGY	PG&E		SCE		SDG&E*		SCG		POU		TOTAL	
	#	MW	#	MW	#	MW	#	MW	#	MW	#	MW
Solar PV	57,069	558	26,897	297	13,482	111	264	14	10,360	110	108,072	1,090
Wind	253	7	369	5	35	0.1	5	0.1	0	0	662	12
RF**	52	19	23	9	12	7	14	9	0	0	101	44
– FC	25	10	15	6	7	6	10	6	0	0	57	28
– MT	14	2	4	1	4	1	0	0	0	0	22	4
– IC	13	7	4	2	1	1	4	3	0	0	22	12
Non-RF***	210	79	81	33	44	24	121	75	0	0	456	211
– FC	65	11	5	1	9	3	16	2	0	0	95	17
– MT	42	8	27	5	13	1	38	6	0	0	120	20
– GT	4	5	0	0	3	9	4	16	0	0	11	31
– IC	99	55	49	27	19	10	63	50	0	0	230	142
AES	1	1	0	0	0	0	0	0	0	0	1	1
Total	57,585	663	27,370	345	13,573	142	404	98	10,360	110	109,292	1,357

Notes:

*California Center for Sustainable Energy (CCSE) is the CSI and SGIP program administrator for SDG&E.

**Renewable Fuels (RF) includes biomass, digester gas, and landfill gas.

***Non-Renewable Fuels (Non-RF) includes natural gas, propane gas, waste gas, and any installations for which the fuel type is not specified.

FC = Fuel Cells; MT = Microturbines; GT = Gas Turbines; IC = Internal Combustion Engines; AES = Advanced Energy Storage

Based on this analysis, the total number of DG installations in the state reached nearly 110,000 by the end of 2011 and provided a total installed capacity of over 1,350 MW ac. Of this total,

Center for Sustainable Energy (CCSE) is the CSI and SGIP program administrator for SDG&E. Renewable Fuels (RF) include biomass, digester gas, and landfill gas; Non-Renewable Fuels (Non-RF) include natural gas, propane gas, waste gas, and any installations for which the fuel type was not specified.

¹⁴ QFs are facilities designated under the Public Utility Regulatory Policies Act of 1978 (PURPA) to receive special rate and regulatory treatment. They fall into two broad categories: 1) small power production facilities less than 80 MW whose primary energy source is renewable (e.g. hydro, solar, and wind), or 2) cogeneration facilities.

1,090 MW ac are solar PV installations. These numbers continue to increase rapidly. For example, at the end of 2012 the total customer-side DG installed throughout the state was about 1,800 MW; this information is included in Appendix D.

Figure 3-2, Figure 3-3, and Figure 3-4 below display the cumulative DG capacity installed each year since 1998, by program and by technology (Figure 3-4 is a more detailed display of the non-solar DG shown in Figure 3-3). The largest group of additions since 2009 has been solar PV technologies developed through the CSI and SB 1 POU programs. Updated versions of the figures below including 2012 data are included in Appendix D.

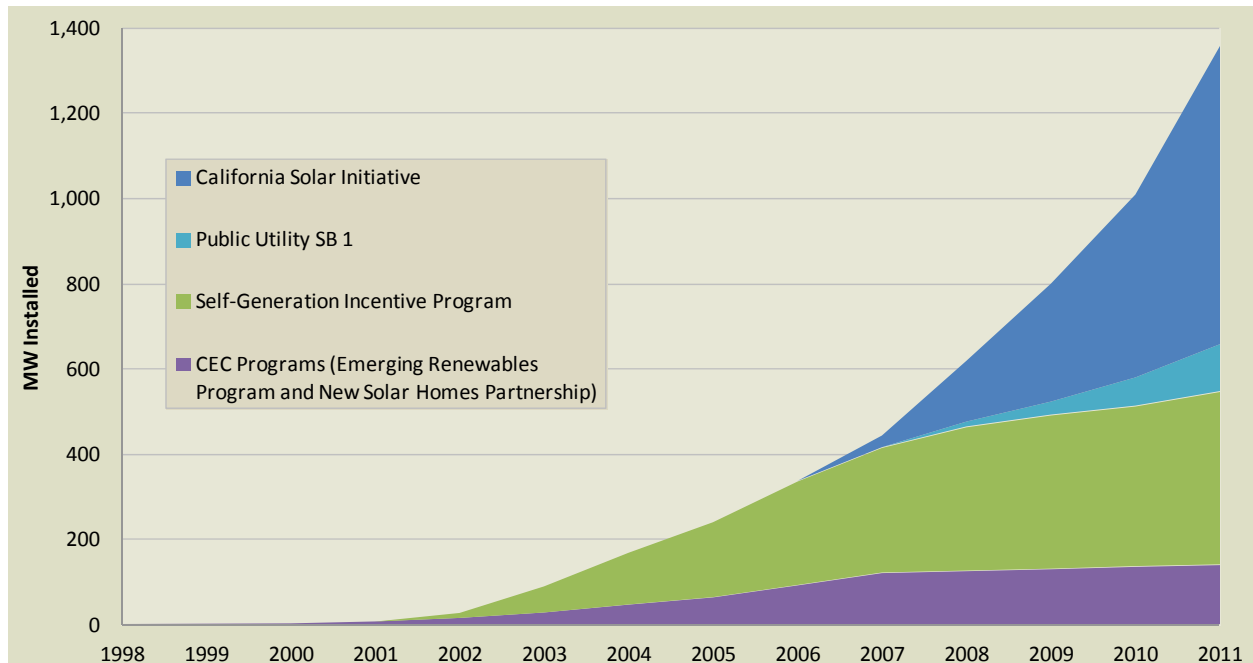

Figure 3-2 Cumulative DG Capacity Installed by Program

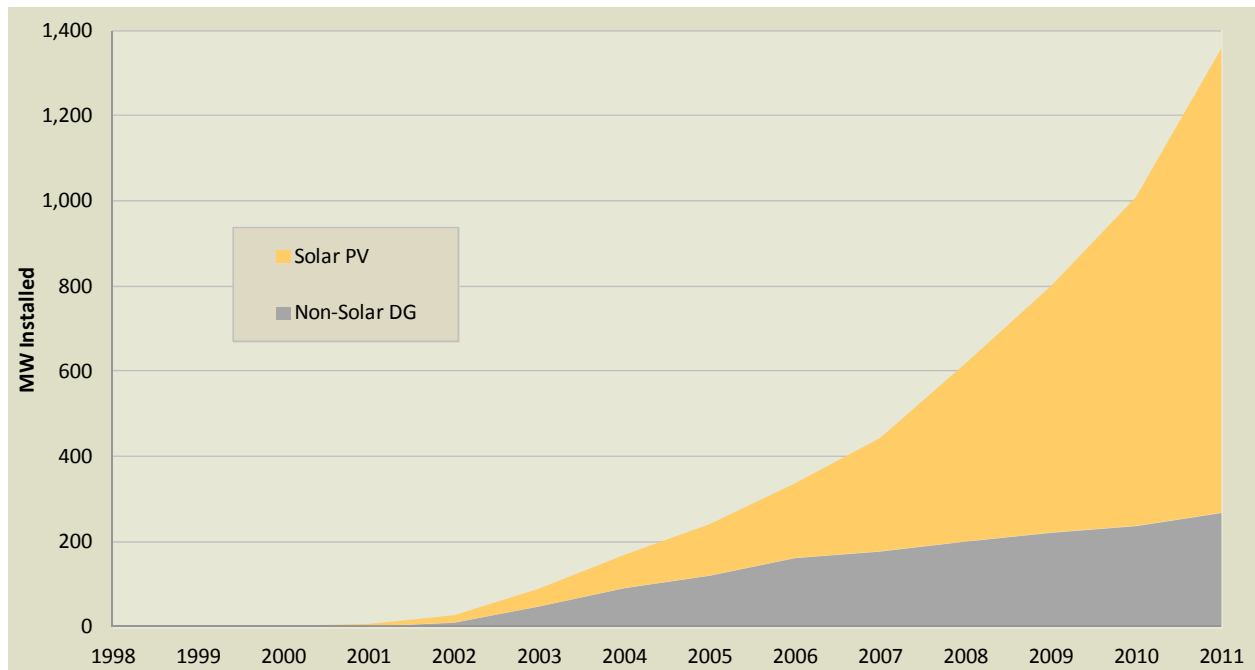

Figure 3-3 Cumulative DG Capacity Installed by Technology

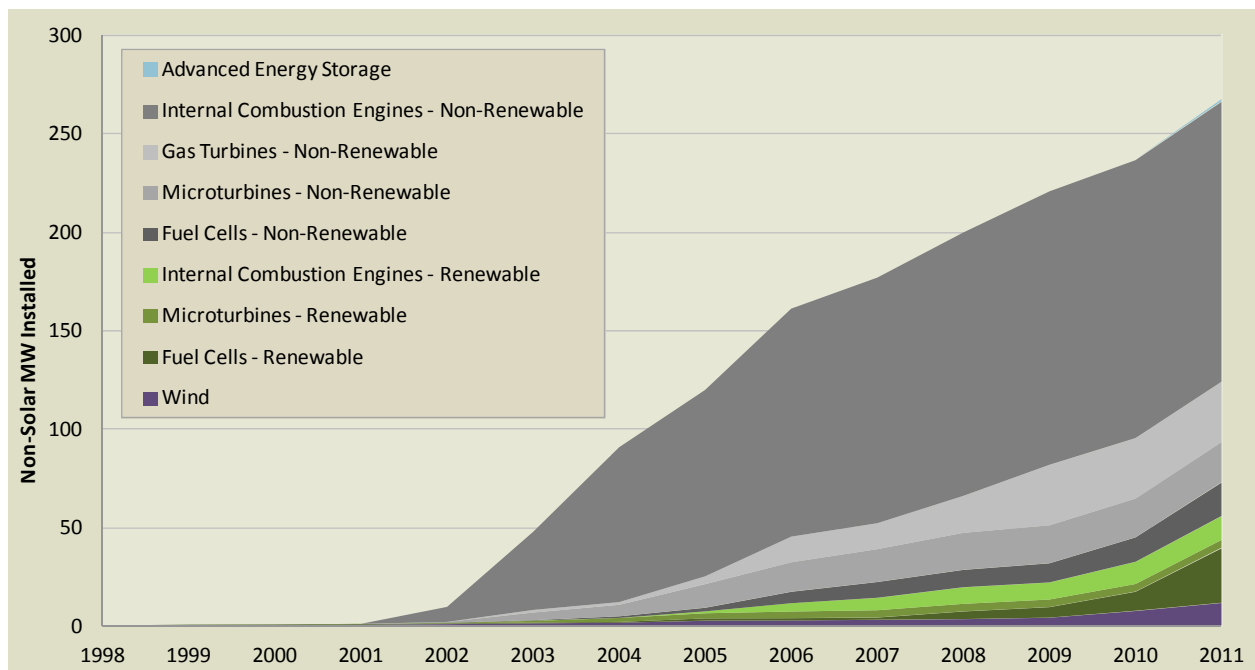

Figure 3-4 Cumulative Non-Solar DG Capacity Installed by Technology

The following subsections describe the California DG programs in more detail, and also provide installed capacity data for each. Section 3.2.1 covers customer-side DG programs, Section 3.2.2

covers the NEM tariff and non-NEM DG installations, and Section 3.2.3 covers wholesale DG programs.

3.2.1 Customer-Side DG Incentive Programs

This section describes the eight customer-side DG programs in more detail. These programs provide financial incentives to support the installation of DG on the customer's side of the meter to offset on-site electricity consumption. Each program is described below, and the DG capacity installed under each program is summarized in Table 3-4.

California Solar Initiative

The CSI program has three components as described below. It is currently the primary incentive program for solar PV in the state, and is overseen by the CPUC with each utility administering the CSI in its own service territory.¹⁵ It provides either rebates in the form of upfront Expected Performance-Based Buydown (EPBB) incentives or ongoing performance-based incentives (PBI) to customers of the three major investor-owned electric utilities in California (PG&E, SCE, and SDG&E) who install solar PV systems between 1 kW and 1 MW. It began in 2007 and has a goal of installing 1,940 MW of solar PV in California by 2016.

CSI – General Market

The General Market (GM) portion of the CSI program encompasses the majority of residential, commercial, non-profit, government and industrial customers. Through the end of 2011, almost 63,000 projects have been installed for a total of 689 MW. Since then, there has been significant additional growth, and by December 31, 2012 the total reached 91,256 projects and 1,031 MW. Though the CSI GM program is not scheduled to end until 2016, all three program administrators are nearing the end of their available incentives as of March 2013. There are ten incentive levels, and as more incentives are reserved, the incentive levels are designed to “step down” over time. PG&E has reached the tenth and final step for both residential and non-residential customers, SCE has reached the ninth step for both residential customers and the eighth step for non-residential customers, and SDG&E has reached the tenth step for residential customers and the eighth step for non-residential customers.¹⁶

CSI – Multi-family Affordable Solar Housing

Under CSI, there are two low-income programs—Multi-family Affordable Solar Housing (MASH) and Single-family Affordable Solar Housing (SASH)—that promote solar PV installations. The MASH program provides rebates to low-income multi-family housing units that install solar PV systems. Five percent of the CSI budget is allocated to MASH. Its framework was adopted and the program officially began in October 2008. Through 2011, 143 projects have been installed for a total of 7 MW.

CSI – Single-family Affordable Solar Housing

The SASH program is also part of the CSI and provides rebates to low-income single-family housing units that install solar PV systems. Five percent of the CSI budget is allocated to SASH. It began in November 2007, and is administered by the non-profit organization GRID Alternatives on behalf of the CPUC. (In Table 3-4, the MW installed for the SASH program are allocated to each Program Administrator based on the share of the total number of installations.) Through 2011, 1,185 projects have been installed for a total of 3 MW.

¹⁵ California Center for Sustainable Energy (CCSE) is the CSI and SGIP program administrator for SDG&E.

¹⁶ <http://csi-trigger.com/>, accessed September 26, 2012.

CSI Summary

Table 3-4 summarizes the status of the CSI program through the end of 2011 by program and utility. While the MASH and SASH programs have 10 percent of the overall program budget allocated to them, they only comprised about 1 percent of the MW installed through the end of 2011.

Table 3-4 Summary of CSI Installations by Program and Utility (All Solar PV)

PROGRAM	PG&E		SCE		SDG&E*		TOTAL	
	#	MW	#	MW	#	MW	#	MW
General Market	35,194	384	19,305	226	8,452	79	62,951	689
MASH	74	3	38	3	31	2	143	7
SASH	613	2	410	1	162	0.5	1,185	3
CSI Total	35,881	389	19,753	230	8,645	81	64,279	700

Notes:

*California Center for Sustainable Energy (CCSE) is the CSI and SGIP program administrator for SDG&E.

Self-Generation Incentive Program

The Self-Generation Incentive Program (SGIP) was initiated in 2001 to provide customers incentives to install their own generation and help reduce peak electricity demand in the state. It is overseen by the CPUC with each utility administering the SGIP in its own service territory. It provides rebates to customers of four investor-owned utilities in California (PG&E, SCE, SCG, and SDG&E) who install DG systems. The current list of eligible technologies includes: wind turbines, fuel cells, gas turbines, microturbines, internal combustion engines, advanced energy storage, pressure reduction turbines, and bottoming cycles. System sizes cannot exceed 100 percent of the customer's peak load, except wind turbines may be sized up to 200 percent of the customer's peak load. Solar PV systems over 30 kW were an eligible technology until 2007, when the CSI program began; PV systems under 30 kW were part of the ERP. Nearly 1,500 projects have received rebates under SGIP for a total of 406 MW. The 2011 SGIP Impact Evaluation report notes that there are a number of SGIP projects that have been decommissioned (i.e. they have been removed from operation), and also a number whose operating status is unknown. Table 3-5 below shows the total rebated capacity under SGIP, but there are currently 20 MW of decommissioned systems and 45 MW of systems with unknown operating status. The decommissioned systems are not included in the peak demand impact analysis described in Section 4.4.

Table 3-5 Summary of SGIP Installations by Technology and Utility

TECHNOLOGY	PG&E		SCE		SDG&E*		SCG		TOTAL	
	#	MW	#	MW	#	MW	#	MW	#	MW
Solar PV	493	81	232	36	103	13	90	13	918	143
Wind	7	6	3	2	0	0	0	0	10	8
RF**	52	19	20	9	12	7	14	9	98	44
– FC	25	10	12	5	7	6	10	6	54	28
– MT	14	2	4	1	4	1	0	0	22	4
– IC	13	7	4	2	1	1	4	3	22	12
Non-RF***	210	79	81	33	44	24	121	75	456	211
– FC	65	11	5	1	9	3	16	2	95	17
– MT	42	8	27	5	13	1	38	6	120	20
– GT	4	5	0	0	3	9	4	16	11	31
– IC	99	55	49	27	19	10	63	50	230	142
AES	1	1	0	0	0	0	0	0	1	1
Total	763	185	336	80	159	44	225	97	1,483	406

Notes:

*California Center for Sustainable Energy (CCSE) is the CSI and SGIP program administrator for SDG&E.

**RF includes the following fuel types: biomass, digester gas, and landfill gas.

***Non-RF includes the following fuel types: natural gas, propane gas, waste gas, and installations for which the fuel type is not specified.

The numbers listed in this table represent all rebated systems under SGIP, including decommissioned systems and systems whose operating status is currently unknown.

FC = Fuel Cells; MT = Microturbines; GT = Gas Turbines; IC = Internal Combustion Engines; AES = Advanced Energy Storage

Emerging Renewables Program

The CEC administers the Emerging Renewables Program (ERP), which provides rebates to customers of California utilities for installing solar PV, wind, or fuel cell systems under 30 kW. It was established in 1998 to stimulate market demand for distributed generation technologies, and was the primary incentive program for these technologies until the beginning of the SGIP. After the CSI program began in 2007, solar PV systems were no longer eligible for the program. The program was discontinued in late June 2012 in accordance with Senate Bill 1018 (Stats. 2012, ch. 39). Nearly 29,000 projects have been installed under ERP for a total of 128 MW.

Table 3-6 Summary of ERP Installations by Technology and Utility

TECHNOLOGY	PG&E		SCE		SDG&E		OTHER*		TOTAL	
	#	MW	#	MW	#	MW	#	MW	#	MW
Solar PV	17,569	79	6,175	29	4,123	15	174	1	28,041	123
Wind Turbines**	246	1	366	3	35	0.1	5	0.1	652	4
Fuel Cells	0	0	3	0.4	0	0	0	0	3	0.4
Total	17,815	80	6,544	32	4,158	15	179	1	28,696	128

Notes:

* In addition to the three large investor-owned electric utilities, some other small utilities participated in the ERP, and these installations are included in the "Other" columns.

**Installations categorized as "Solar PV & Wind" are included in the "Wind Turbines" category.

New Solar Homes Partnership

The New Solar Homes Partnership (NSHP) is administered by the CEC and began in 2007 as a complementary program to the CSI. Its focus is to provide financial incentives and other support to home builders to encourage them to integrate solar PV into highly energy-efficient new residential housing built in California. The ultimate goal of the program is 360 MW of solar PV on new residential developments by 2016. Nearly 4,500 projects have been installed under NSHP for a total of 14 MW.

Table 3-7 Summary of NSHP Installations by Utility

TECHNOLOGY	PG&E		SCE		SDG&E		TOTAL	
	#	MW	#	MW	#	MW	#	MW
Solar PV	3,126	9	737	2	611	3	4,474	14

SB 1 POU Programs

Senate Bill 1, which took effect in 2007, required all public utilities to establish incentive programs for solar PV similar to the CSI program. Each utility administers its own program. The overall goal is for public utilities to install 700 MW by 2016. The CEC tracks SB 1 installations of each public utility. Los Angeles Department of Water & Power (LADWP) and Sacramento Municipal Utility District (SMUD) are the two largest public utilities in California and have the majority of POU customer installations in the state. All POU combined have installed over 10,000 solar PV projects for a total of 110 MW.

Table 3-8 Summary of SB 1 POU Installations by Utility

TECHNOLOGY	LADWP		SMUD		ALL OTHERS		TOTAL	
	#	MW	#	MW	#	MW	#	MW
Solar PV	3,027	32	2,952	31	4,381	46	10,360	110

Renewable Energy Self-Generation Bill Credit Transfer Program

The Renewable Energy Self-Generation Bill Credit Transfer (RES-BCT) Program was created as a result of AB 2466 (Laird, 2008). The tariffs approved by the CPUC under this program allow local governments to generate electricity at one account and transfer any available excess bill credits (in dollars) to another account owned by the same local government. DG systems eligible under this program must be less than 5 MW, and there is a statewide program limit of 250 MW. As of the end of 2011, there were no known DG installations participating in this program.

3.2.2 NEM Tariff and Non-NEM DG Installations

The NEM tariff was established by legislation and is implemented by the CPUC for electric customers who install solar, wind, biogas or fuel cell systems of 1 MW or less. To be eligible for the NEM tariff, generation must be sized to primarily offset on-site electrical load. Under the NEM tariff, a customer is allowed to send power to the utility when they are generating more power than they consume. Customers receive a full retail rate credit for all generation exported to the grid over the course of a year, up to the amount of their annual usage. This credit can be used to offset all kWh-based charges except minimum monthly charges or customer charges. If the customer's exports over the course of a year are greater than the customer's annual usage, they are compensated for the excess at the day-ahead market price (which is generally lower than retail rates). The majority of customer-side DG installations take advantage of this tariff (summarized in Table 3-9), although there are some which do not (summarized in Table 3-10), often because they do not anticipate ever exporting power back to the grid.

Each IOU tracks NEM and non-NEM DG installations through interconnection information and reports this data to the CPUC quarterly through the "Distributed Generation Interconnection Data Requests" (DG Interconnection Dataset). There are a total of about 1,580 MW of reported installations interconnected to the three IOUs, both NEM and non-NEM. These installations are not additive to the installed capacity reported in Section 3.2.1. The data shown in the tables below are based solely on the interconnection datasets, and have not been independently verified by Black & Veatch.

Table 3-9 Summary of NEM DG Installations by Technology and Utility

TECHNOLOGY	PG&E		SCE		SDG&E		TOTAL	
	#	MW	#	MW	#	MW	#	MW
Solar PV	59,946	616	27,998	310	13,483	116	101,427	1,042
Wind	149	4	316	5	42	0.1	507	9
FC	79	13	27	5	0	0	106	18
IC	11	94	0	0	0	0	11	94
Multiple / Other*	123	26	65	6	2	0	190	32
Total	60,308	753	28,406	327	13,527	116	102,241	1,196

Notes:

* Multiple/other includes multiple technologies or technologies that do not fall into the DG categories covered by the customer-side DG incentive programs above.

FC = Fuel Cells; IC = Internal Combustion Engines

This table includes all NEM installations, including those on the Standard NEM tariff and those on the NEMW, NEMFC, and NEMBIO tariffs. Standard NEM and NEMW provide the full retail rate, while NEMFC and NEMBIO cover only the generation portion of the rate.

Table 3-10 Summary of Non-NEM DG Installations by Technology and Utility

TECHNOLOGY	PG&E		SCE*		SDG&E*		TOTAL	
	#	MW	#	MW	#	MW	#	MW
Solar PV	249	39	40	15	-	-	289	54
Wind	2	2	-	-	-	-	2	2
FC	13	7	-	-	-	-	13	7
MT	44	10	-	-	-	-	44	10
GT	15	89	-	-	-	-	15	89
IC	122	122	-	-	-	-	122	122
Multiple / Other**	19	99	-	-	-	-	19	99
Total	464	368	40	15	-	-	504	383

Notes:

* SCE and SDG&E did not report any non-NEM installations (except that SCE reported a small number of solar PV systems), because the CPUC did not require them to be reported.

** Multiple/other includes multiple technologies or technologies that do not fall into the DG categories covered by the customer-side DG incentive programs above.

FC = Fuel Cells; MT = Microturbines; GT = Gas Turbines; IC = Internal Combustion Engines

3.2.3 Wholesale DG Programs

In addition to the customer-side programs described above, CPUC also oversees three primary wholesale renewable DG programs, in which projects are interconnected on the utility side of the meter.¹⁷ These programs require the IOUs in California to sign power purchase agreements (PPA) with larger DG projects between 1 and 20 MW. Added together, the goals of the wholesale DG programs are approximately 3,150 MW. As of the end of 2011, a total of 101 MW have been installed under these programs.

Feed-In Tariff (AB 1969 and SB 32)

The feed-in tariff (FIT) program began in California in 2006, when Assembly Bill 1969 (Yee, 2006) was passed to authorize special tariffs and standard contracts for public water and wastewater utilities to install renewable energy projects up to 1.5 MW. These tariffs were made effective by the CPUC in February 2008, and applied only to PG&E and SCE. Senate Bill 380 (Kehoe, 2008) created a single tariff for all utility customers and added SDG&E. Senate Bill 32 (Negrete-McLeod, 2009) was passed in 2009 and increased eligible project size to 3 MW. All public and investor-owned utilities in California are required under SB 32 to develop FIT programs. The overall statewide goal is 750 MW under SB 32, but there is no set date by which utilities must reach this target.

¹⁷ Qualifying facilities under PURPA (for renewables and gas-fired generation), efficient combined heat and power under AB 1613, and bioenergy facilities under SB 1122 programs are other programs in which distributed sellers may be interconnected to the utility distribution system, and thus be considered DG. These programs are not included in this report.

Twenty-one projects have been contracted and brought online through AB 1969 by the IOUs totaling 18 MW. These are summarized in Table 3-11 below by technology. There were no recorded installations under SB 32 as of the end of 2011.

Table 3-11 Summary of FIT – AB 1969 Installations by Technology

TECHNOLOGY	PG&E		SCE		SDG&E		TOTAL	
	#	MW	#	MW	#	MW	#	MW
Biogas	3	2	1	1	4	6	8	9
Biomass	1	1	0	0	0	0	1	1
Small Hydro	10	6	0	0	0	0	10	6
Solar PV	0	0	2	2	0	0	2	2
Total	14	8	3	3	4	6	21	18

Utility Solar PV Programs

In 2009 and 2010, SCE, PG&E and SDG&E were authorized by the CPUC to initiate Solar PV Programs (SPVP) to procure the output from wholesale solar PV projects through two mechanisms: 1) developing their own utility-owned generation (UOG) projects, and 2) signing contracts with independent power producers (IPP) in their service territories. Originally, the programs totaled 1,100 MW, but SCE and SDG&E asked for a portion of the program to be merged into the Renewable Auction Mechanism program (described in next section). The current goal is 776 MW. System sizes vary across the utilities, but generally range from 500 kW up to a maximum of 20 MW. The goals for each utility are as follows:

- PG&E has a total program goal of 500 MW, split evenly between UOG and IPP projects. In December 2012, PG&E submitted a request to the CPUC to move 252 MW of solar PV from this program to the RAM program.
- SCE originally had a program goal of 500 MW, split evenly between UOG and IPP projects. However, SCE sought CPUC permission to reduce this to 250 MW, again split evenly between UOG and IPP projects. SCE sought approval to move 225 MW to the RAM program, which the CPUC granted.¹⁸
- SDG&E had an original program goal of 100 MW which is split into 26 MW of UOG projects and 74 MW of IPP projects. Similar to SCE, SDG&E sought and received approval to move the 74 MW of IPP projects to the RAM program.¹⁹

Table 3-12 shows that as of the end of 2011, 83 MW had been installed toward those goals.²⁰

¹⁸ Southern California Edison, "Southern California Edison Company's (u 338-e) Third Annual Compliance Report on the Solar Photovoltaic Program", July 2, 2012, available at: [http://www3.sce.com/sscc/law/dis/dbattach4e.nsf/0/3D14CD4ADEC4C8A488257A2F0080B23D/\\$FILE/A0803015_R1105005+-SCE+3rd+Annual+SPVP+Compliance+Report_Public.pdf](http://www3.sce.com/sscc/law/dis/dbattach4e.nsf/0/3D14CD4ADEC4C8A488257A2F0080B23D/$FILE/A0803015_R1105005+-SCE+3rd+Annual+SPVP+Compliance+Report_Public.pdf)

¹⁹ CPUC, "RPS Quarterly Report – 1st and 2nd Quarter 2012", available at: http://www.cpuc.ca.gov/NR/rdonlyres/2060A18B-CB42-4B4B-A426-E3BDC01BDCA2/0/2012_Q1Q2_RPSReport.pdf

Table 3-12 Summary of IOU Solar PV Program Installations by Ownership

OWNERSHIP	PG&E		SCE		SDG&E		TOTAL	
	#	MW	#	MW	#	MW	#	MW
Utility-owned	4	52	7	12	0	0	11	64
Independent Power Producer	0	0	8	19	0	0	8	19
Total	4	52	15	31	0	0	19	83

Renewable Auction Mechanism

The Renewable Auction Mechanism (RAM) program began in 2011 when the CPUC approved it as a simplified procurement mechanism for wholesale renewable DG projects. The CPUC initially authorized the IOUs to procure 1,000 MW, which was then expanded to 1,299 MW by CPUC decisions D.12-02-035 and D.12-02-002. Projects between 3 and 20 MW must meet certain eligibility criteria, and must sign a pre-approved standard PPA. Auctions are held twice per year, with the first auction in November 2011. Contracts from this first auction were approved by the CPUC in April 2012, so there were no operational projects as of the end of 2011. Additional auctions are planned in 2012 and beyond.

²⁰ The totals are based on the CPUC RPS Contract database. However, at least in the case of SCE, they do not appear to exactly match the numbers in the compliance filing referenced above.

4.0 DG Impacts on the Transmission and Distribution System

As discussed in this section, DG may have positive and negative impacts on the transmission and distribution system. Because of the direct connection of DG to the distribution system, impacts are expected to be most prevalent at the distribution level. However, as the penetration of DG increases, the impacts will begin to be observed on the transmission system.

Many of the impacts of DG are attributable to the fact that the grid was not originally designed to accept generation on the distribution system. Traditionally, centralized generation was connected to the transmission system, which supplied the distribution system, which in turn fed the majority of loads. This design is depicted in the figure below, illustrating the flow of electric power from generation, through transmission, through the distribution system, and on to customer loads. The distribution system is generally defined as the portion of the grid with a voltage of 40 kV or less.²¹ The transmission system is generally the portion of the grid that operates above 40 kV.

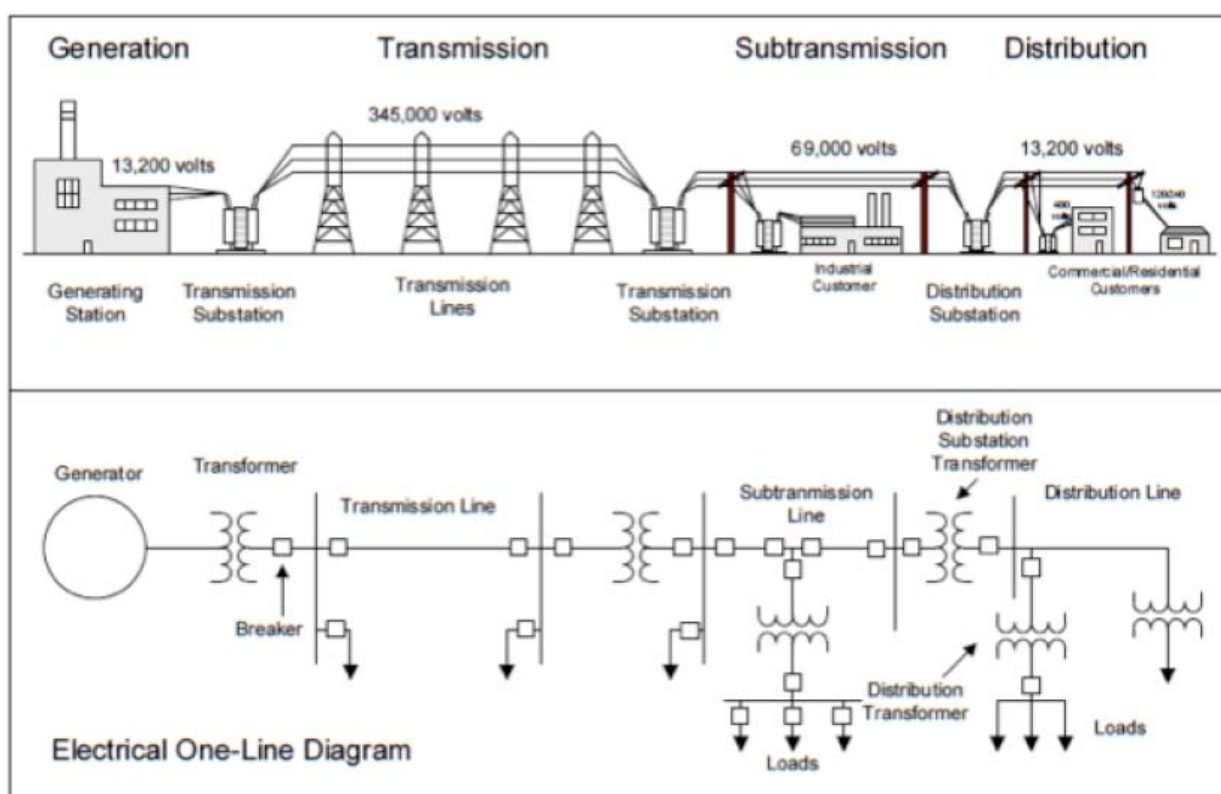

Figure 4-1 Typical Electric Power System Single-Line Diagram²²

The following topics are covered in this section:

- Section 4.1 – Impacts of DG on the distribution system

²¹ Distribution voltage definition per the Institute of Electrical and Electronics Engineers (IEEE) Standard 141 is a nominal voltage of 40 kV or less. Often, voltage levels between 40 kV and 138 kV are considered to be “subtransmission;” however, this report discusses both subtransmission and transmission as transmission. Each utility in California operates its own distribution system of varying voltage levels.

²² J. Keller and B. Kroposki, “Understanding Fault Characteristics of Inverter-Based Distributed Energy Resources,” National Renewable Energy Laboratory, Golden, CO, January 2010, p. 31.

- Section 4.2 – Impacts of DG on the transmission system
- Section 4.3 – Effects of a DG system’s size and location on its grid impacts
- Section 4.4 – Impact that DG has on the CAISO peak demand

While a number of impacts are described in this section, it is important to note few have been widely observed. If they have been observed, it is difficult to conclusively attribute them to *customer-side* DG systems. The impacts described here have been identified through modeling, research, or limited real-world observations. The lack of observed impacts can be attributed to several reasons:

- Currently about 90 percent of connected DG capacity is on the customer-side of the meter
- Customer-side DG systems are typically small
- The current penetration level of DG is low
- At the given penetration levels, the interconnection process and requirements have successfully mitigated impacts before they occur
- There is a general lack of monitoring DG system output²³ and of the effects of DG systems on the grid (that is, utilities do not have the appropriate tools to systematically collect and evaluate data on problems or benefits attributable to DG).

For these reasons, it is difficult to quantify the impacts of customer-side DG on the grid. It is expected by many that impacts will increase as DG penetration increases. However, to be able to quantify the impacts, the utilities will need to begin systematically monitoring for them and then associating them with DG systems. Furthermore, the utilities have noted that data collection or monitoring alone will not necessarily lead to a better understanding of the impacts of DG on the grid. Formal research and development is required to facilitate better understanding of issues and benefits correlated to DG.

Quantification of DG impacts is vitally important to the DG industry, utilities and policymakers. It will inform decisions that seek to further DG goals while minimizing the negative impacts of DG and maximizing its benefits.

4.1 DISTRIBUTION SYSTEM RELIABILITY AND OPERATION

Impacts of DG on distribution system reliability and operation are described in this section. It is important to note, however, that impacts are highly dependent on the local feeder configuration and loading level.²⁴ Impacts discussed in this section include the following:

- Distribution system line losses
- Peak demand reduction

²³ As noted above, currently only units 1 MW or larger have telemetering requirements. Smaller units do not have this requirement since at lower penetrations the expectation was that the impacts would be minimal, the cost to collect the data would be relatively high, and processing of this additional data may not be necessary. This assumption should be revisited as penetration increases or the operational requirements for DG change. In that vein, California utilities have recently proposed telemetering requirements for certain wholesale DG smaller than 1 MW where the power will be exported and scheduled into CAISO’s market. As of this writing, the CPUC has not yet evaluated those proposals.

²⁴ Itron, “Final 2007-2009 Impact Evaluation,” Submitted to: Southern California Edison and California Public Utilities Commission Energy Division, February 2010, p. 4-30.

- Deferred distribution system upgrades
- Frequency control²⁵
- Voltage control
- Reverse power flow
- Operation flexibility

4.1.1 Distribution System Line Losses

DG systems have the potential to reduce the amount of energy lost due to transmitting energy over long distances on distribution lines. Typically, energy travels from a centralized generating source through substations to load. Because DG supplies local loads, less energy is required to travel from centralized sources, and distribution losses may be reduced. However, in some cases DG may actually increase losses. For example, if a DG system is injecting more power onto the distribution system than conductors were originally designed for, losses could actually increase.

Some researchers have modeled distribution systems and found there to be an optimal penetration level to minimize line losses on a single feeder. For example, UC Irvine and PG&E researches have modeled two feeders and found the optimal penetration level to reduce line losses is approximately 60 percent. Above those levels line losses begin to increase.²⁶ As a reference, current penetration levels in California are generally below 10 percent.

During interviews with IOUs, distribution line losses were not mentioned as an impact of DG. While reduction in distribution line losses should theoretically be occurring as DG increases and reverse power flow is limited, the utilities are not systematically quantifying this benefit, or possible cost, and associating it to DG. It may be possible to more closely track this metric as utilities gain more intelligence about distribution system performance through smart grid upgrades.

4.1.2 Peak Demand Reduction

To the extent DG output is correlated with local loads, DG may reduce the peak load on some parts of the distribution system. The amount of peak demand reduction will depend on the type of DG resource, its operating pattern, and the load profile for the feeder or substation. Peak demand reduction is generally viewed as a positive impact as it reduces the required capacity and equipment for the system. Peak demand reduction is explored further in Section 4.4, which analyzes the impact on total system peak as well as some selected distribution feeders.

4.1.3 Deferred Distribution System Upgrades

DG can reduce the utilization of the distribution system as less energy is required to be transported over the system (as described above), and this is generally viewed as a potential positive impact of DG. With installation of DG, the net load seen by the distribution system may not have increased as significantly as expected, or the system might age slower than expected because it is used less. To some extent, planned upgrades to the distribution system for capacity increases or replacement of devices because of wear and tear may be partially delayed or deferred if DG systems are located

²⁵ It should be noted that the frequency of the distribution system and transmission system is the same, and therefore impacts to frequency on the distribution system similarly affect the transmission system. For simplicity, the frequency control impact is listed and discussed under distribution system impacts here.

²⁶ J. Payne, F. Gu, J. Brouwer, S. Samuelson, M. Heling, J. Carruthers, D. Pearson, "Evaluation of High Pen PV in Distribution Circuits", High Penetration Solar Forum 2013, February 2013.

and designed appropriately.²⁷ However, system upgrades and maintenance are impacted by several factors such as age, temperature and weather conditions, surrounding equipment, and so on.

Unfortunately, based on interviews with IOUs, they were unaware of DG systems in California that have provided this benefit. In fact, IOUs indicated that the installation of some DG systems can require upgrades to the distribution system; for instance, since DG increases the voltage at the point of interconnection, IOUs may need to perform upgrades to prevent voltage from exceeding allowable limits, particularly if there is a high level of generation during off-peak conditions. Further, increased cycling of equipment (such as capacitor banks) due to intermittent renewables may increase maintenance requirements.

To achieve this benefit would require strategic location of DG on the distribution system. Utilities also desire that the DG be available or dispatchable, including potentially contractual obligations to provide reliable power. However, there are no incentives for DG system owners or developers, specifically wholesale DG, to locate DG in locations that provide the maximum benefit in the form of deferred distribution system upgrades. This may be a barrier to further cost-effective deployment of DG, as discussed in Section 5.2.1.

In addition, PG&E has suggested that distribution design standards may need to be reviewed to see if modifications to system design could increase the benefits of distributed generation, or at least mitigate the impacts such that higher penetrations could be achieved at a lower overall cost.

4.1.4 Frequency Control

The CPUC Rule 21 and IEEE standards provide frequency requirements for DG connecting to the distribution system. These requirements provide the upper and lower limits for the frequency of the DG system. When the frequency goes outside of the specified range, the DG systems will automatically be tripped offline.

Energy generating technologies that have inertia, such as combustion turbines, provide frequency support – meaning they can help adjust the frequency of the grid. This can be done by either speeding up or slowing down the rotation of the devices.

The most prevalent DG technologies, such as solar PV, do not provide frequency support. In fact, these systems are required to trip offline (UL 1741) in the event of an over or under frequency situation. The net effect of DG systems tripping offline could, in the future when higher penetration is achieved, exacerbate an under frequency situation; this is viewed as a negative impact of DG.

While frequency impacts have been seen in models and actual system frequency data, the IOUs are not able to attribute these impacts to customer-side DG systems. The expectation is that as DG penetration increases utilities will be able to attribute these impacts, or the exacerbation of these impacts, to particular systems.

Changes to inverter standards (specifically IEEE 1547), such as allowing a wider range of voltage and frequency conditions, could help alleviate challenges with inadvertent voltage and frequency trips. Smart inverters could also help mitigate the frequency impact of DG. Smart inverters may be able to provide frequency support, or avoid tripping offline during some under/over frequency events.

²⁷ U.S. Department of Energy, “The Potential Benefits of Distributed Generation and Rate-Related Issues that May Impede Their Expansion,” February 2007, p. 3-11.

4.1.5 Voltage Regulation

Voltage regulation is a core function of utility operations, and DG has the potential to make voltage regulation significantly more difficult for utilities. Voltage is typically controlled locally at the distribution level. Adding generation on a feeder that normally serves load will increase the voltage at the point of interconnection. If the DG is solar, wind, or any sort of variable DG, there could be voltage fluctuations on the feeder. Figure 4-2 below illustrates an intermittent solar resource. The variability of solar PV generation can be quite high, particularly on partly cloudy days.

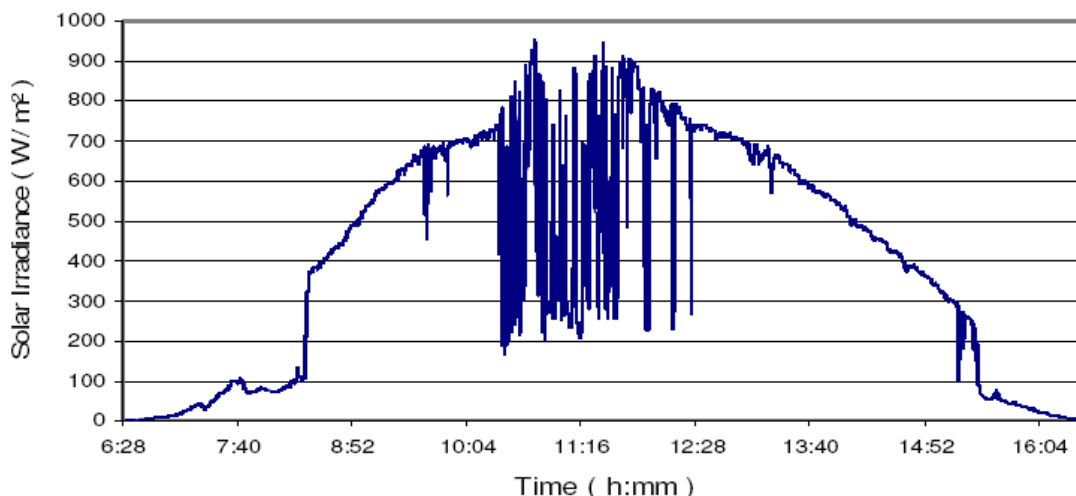

Figure 4-2 Sample Solar Resource Data for One Day²⁸

Passing cloud cover and other disturbances can affect DG output, which affects grid voltage, and may ultimately impact system operation triggering protection devices. An NREL report, *Impact of SolarSmart Subdivisions on SMUD's Distribution System*, indicated that at low PV penetration levels, no adverse voltage regulation effects were found; however, as penetrations increase, an effect may be seen.²⁹ The voltage fluctuation may lead to voltages outside acceptable ranges imposed by the CPUC Rule 2 (Conservation Voltage Regulation – CVR) and IEEE standards. Fluctuation in voltage can cause wear and tear to electrical equipment owned by customers and utilities, and is viewed as a negative impact that DG systems can have on the distribution system.

At current penetration levels, widespread voltage issues have not been observed, but they are expected to occur more often as more DG systems are installed. Based on interviews with distribution engineers, the IOUs have observed some instances of voltage impacts. SDG&E indicated they have experienced adverse voltage fluctuation on a feeder hosting two 1-MW NEM solar PV installations. On a SCE feeder, a 400 kW PV system at full output increased voltage enough to trip the inverter off; because of this, SCE installed a new transformer and changed the tap setting to handle the voltage fluctuations at its own cost.

²⁸ M. Patsalides, A. Stavrou, G. Makrides, V. Efthimiou and G. E. Georghiou, "Harmonic Response of Distributed Grid Connected Photovoltaic Systems," University of Cyprus, Nicosia, p. 3.

²⁹ P. McNutt, J. Hambrick, M. Keese, and D. Brown, "Impact of SolarSmart Subdivision on SMUD's Distribution System," National Renewable Energy Laboratory, Golden, CO, July 2009, p. 33.

SCE indicated that they have observed installations experiencing overvoltages exceeding permitted voltage levels by up to 200 percent. These overvoltage cases are caused by an effect referred to as “transient overvoltage.” For DG systems, this effect is temporary and occurs when a PV DG system inverter disconnects during low load conditions. As a result of transient overvoltages, the PV system’s isolation switch may fail if not sized appropriately, and customer load may be exposed to overvoltages. SCE is working with inverter manufacturers to mitigate this issue and establish proper design protocols for DG PV systems.

Similar to frequency control, a DG system is required to trip offline during an under- or overvoltage event, per UL 1741 inverter requirements. Losing generation causes a decrease in voltage; therefore the tripping offline of DG systems can exacerbate an undervoltage situation.

Some mitigation approaches have been developed or implemented, for example load tap changers on transformers have been used to mitigate voltage issues. Allowing inverters to provide VAR support or installing VAR controllers is a technically viable option. However, this may not be practical for customer-side DG systems given their small size and distributed locations, and the fact that utilities do not currently have control over customer-owned equipment. Changing inverter standards to not require disconnection during temporary low voltage events is a mitigation approach referred to as low-voltage ride-through (LVRT). In 2008, Germany required LVRT on the distribution system.³⁰ SDG&E indicated that several voltage mitigation approaches are technically available, but there is limited research available to indicate the best approach. In Section 7.0, an approach is discussed for a study to examine best practices for addressing the various voltage and frequency impacts of DG on the distribution system.

4.1.6 Reverse Power Flow

As DG penetration increases, the likelihood of generation flowing back onto the distribution grid increases. This is often referred to as “reverse power flow.” Reverse power flow can potentially negatively impact the coordination of DG installations with existing distribution feeder automated protection features and other equipment.

Distribution systems are not generally designed to accommodate the interconnection of widespread parallel generation. Rather, they are designed to distribute power produced from centralized generation connected to the transmission system. Existing distribution systems are generally designed to accommodate power flow out of the distribution system and may have issues with excessive power flowing into the system. Examples of issues that might occur in this situation include:

- Some types of equipment, such as load tap changers that regulate voltage, may not function correctly if electricity is flowing opposite their original design.
- PV systems may not detect faults with low short circuit current on the distribution system and therefore may remain connected to the distribution system. This may interfere with the distribution system operation as the PV system may be feeding the fault and the rest of the distribution system may not detect the fault as it otherwise would without the DG PV system.
- Network distribution systems, which are typically used in urban areas, generally cannot handle significant power flows into the system. This is because there is a device specifically

³⁰ J. Keller and B. Kroposki, “Understanding Fault Characteristics of Inverter-Based Distributed Energy Resources,” National Renewable Energy Laboratory, Golden, CO, January 2010, p. 31.

used for network systems that inhibits power flow into the system for system protection reasons.³¹ This limits the size and amount of PV that can be installed on the system.

One specific example of potential reverse power flow impacts comes from larger PV systems (>20 kW) that have a single-phase output because they are installed on a single-phase service at a multi-family housing complex—this occasionally happens with systems installed under the MASH program. Because of their size, systems over 20 kW usually have a three-phase output. But in situations where a single-phase output is required because of the location, the large amount of power that may be exported to only one of the three phases on the distribution network could create a significant phase imbalance. Distribution operations could be negatively impacted if this were to occur.

The net effect of reverse power flow is possible negative interaction with the distribution system's protection schemes, causing parts of the system to go offline. The level at which reverse power flow becomes problematic for utilities is not easily determined with a simple percentage of capacity penetration; many factors must be taken into account such as magnitude of reverse power flow, capacity of feeder, relay and recloser³² settings, and length of feeder. To mitigate these issues, utilities may reconfigure or redesign their protection schemes. Utilities have indicated that this has been done on a case by case basis to date.

4.1.7 Operational Flexibility

As DG penetration increases, the complexity of the distribution system increases and utilities may have less flexibility to operate their system, potentially negatively impacting the system. The distribution system and its associated protection schemes (protection devices and the coordination between them) were designed to distribute or supply power to loads. With generation sources spread across the system, certain protection schemes will have to change. DG brings additional complexity to the operation and troubleshooting of the distribution system for many reasons, including the fact that the interconnection point may act as a generation source *or* a load. Furthermore, when problems occur on the distribution system, it may be more difficult to troubleshoot them. For these reasons, it is likely that utilities will have less flexibility with their system. For example, many distribution systems are radial in nature, which means there is a long line running from the source, and no loops or redundancy. If a DG system causes an issue with the distribution system somewhere along this line, requiring a portion of the line to be isolated, then the utility may have to disconnect the DG system and anything beyond it from the main source. This limit on operational flexibility may reduce the reliability of the distribution system in some cases.

4.2 TRANSMISSION SYSTEM RELIABILITY AND OPERATION

Transmission system impacts from customer-side DG installations installed to date, particularly those in urban areas with higher load, are characterized as minimal in the studies conducted by the CPUC consultants and others. A literature survey of the topic reveals that the conclusion most often advanced is that the issues have not been experienced at these low levels of DG penetration, but as the penetration levels grow, issues are expected to appear. The issues discussed in the following paragraphs are ones that are largely anticipated, but have generally not been observed on the IOUs systems at the time of this report. Anticipated issues that will likely need to be addressed as they arise include:

³¹ M. Coddington, B. Kroposki, T. Basso, K. Lynn, M. Vaziri, T. Yohn, "Photovoltaic Systems Interconnected onto Secondary Network Distribution Systems – Success Stories," National Renewable Energy Laboratory, Golden, CO, April 2009, p. 8.

³² Relays and reclosers are system protection devices used in distribution and transmission systems.

- Transmission system line losses
- Reverse flow from the distribution system to the transmission system
- Existing operational procedures
- Voltage regulation
- Reliable capacity and planning
- Capacity margin
- System stability

4.2.1 Transmission System Line Losses

As with the distribution system, DG that serves local loads will offset the need to import power through the transmission system at the time that the DG system is producing energy. This should reduce transmission line losses during those times, and is generally viewed as a positive impact of DG. At the present time, the utilities and the CAISO are not routinely quantifying this benefit and associating it with DG.

4.2.2 Reverse Power Flows from the Distribution System

Reverse power flows, as mentioned in the distribution system section above, can have negative impacts. Reverse power flows caused by increased DG would likely occur when DG output exceeds load and the excess energy flows through the distribution system to the transmission system. This is not a widespread issue today, but IOU engineers anticipate that at some level of DG penetration, it may become a problem. While this report specifically examines peak load impacts, the IOU engineers indicated that they will likely see reverse flow issues during off-peak conditions when their loads are a fraction of their peak load, causing excess energy from DG projects to flow back onto the system. If this were to occur, it would also impact transmission operations procedures and the ability to balance system load with resources. The impacts of reverse power flow on the transmission system are different than the distribution system, partially due to the different approaches to operation of the different systems. The literature surveyed for this report did not reveal any specific studies that have been conducted on this issue. Analyses conducted on DG impacts on the transmission system have found that the low level of DG penetration limits any conclusions that can be drawn at this time.³³

4.2.3 Operational Procedures

Much in the same way that distribution system operators will have to adapt as DG penetration levels grow, transmission system operators will also need to adapt, especially if actual energy output differs significantly from the forecasted output. Grid operation may be negatively impacted by both the variability and the uncertainty of variable DG resources.³⁴ Instances of over-generation have recently occurred with wind generation. Similar over-generation with solar DG is most likely to occur in the morning while loads are low, but should a cloud pass, generation can decrease very quickly.³⁵ SCADA has been seen as too expensive to install for monitoring output from smaller DG

³³ Itron, "Impacts of Existing Distributed Generation – Final report," Prepared for CPUC Energy Division Staff, Davis, CA, January 2010. Pages 5-8; 5-13.

³⁴ NREL, "Impact of High Solar Penetration in the Western Interconnection," A Technical Report Prepared by NREL and GE Energy, Golden, CO, December 2010. Page 6.

³⁵ California ISO, "Integration of Renewables Resources: Operational Requirements and Generation Fleet Capability at 20% RPS," August 31, 2010. Pages 12-18.

installations, so the output is typically netted with its native load. As a result, minute-by-minute changes in DG output can appear as unexpected increases or decreases in load. Transmission operators monitor system status around the clock, and have procedures for managing specific scenarios. These would need to be expanded to include how to manage imbalances caused by increased DG on the system as this would be a new phenomenon.

4.2.4 Voltage Regulation

Voltage regulation issues, as mentioned above, can have negative impacts on the system. Voltage regulation issues on the transmission system as a result of DG system additions has not been identified specifically in any of the literature reviewed for this report. Interviews with IOU engineers have revealed that this is not an existing issue on the transmission level substation buses related to customer-side DG, but it is expected to become a problem in the future.³⁶ The DG penetration point at which the IOU engineers think this issue will manifest on a system-wide basis is unknown at this time and it is one they have expressed they would like studied and understood.

4.2.5 Reliable Capacity and Planning

While DG technologies that are not variable can be relied on to produce their capacity as expected, most DG in California is PV which is not forecasted in a reliable way today. Also, because transmission expansion plans look at time horizons anywhere from 5 to 20 years into the future, the question of what capacity to assume for these plans is still a topic of debate. While technical analyses have found that PV resources contribute up to 30 percent capacity values, the ISO uses a calculation that averages peak capacities and uses those values as reliable capacity in planning studies.³⁷ Resource adequacy, the procurement of sufficient flexible demand or generation capacity to meet future loads, is critical to load serving entities.³⁸ Transmission planners are tasked with studying the bulk electric system and identifying mitigation projects for any issues that will impact reliable service to utility customers under peak load conditions. The obligation to serve a customer remains whether or not the customer has a PV system installation. Therefore, transmission planners assign a value of zero to these resources to be confident that they have adequate resources under the critical peak load period.³⁹ A higher confidence in PV forecasting, for instance, would lead to more credit being attributed to PV systems as reliable capacity, a potential positive impact of DG. Also, at higher penetrations, geographic dispersion will provide higher capacity assurance. In other words, many small systems operating in a dispersed grid will not likely have negative impacts as great as larger, less dispersed systems.

There are ongoing regulatory activities which should provide better certainty to the treatment of solar or wind resources as dependable resources in the future. In particular, there are proceedings underway at the CPUC to consider incorporating flexible capacity in the 2014 Resource Adequacy program. That would include preparation and review of new studies of the effective load carrying capacity of wind and solar resources in California.⁴⁰

³⁶ SCE indicated that larger wholesale DG systems do cause voltage regulation issues today.

³⁷ NREL, "How Do High Levels of Wind and Solar Impact the Grid? The Western Wind and Solar Integration Study," Technical Report, Golden, CO, December 2010. Page 10.

³⁸ LBNL, "Mass Market Demand Response and Variable Generation Integration Issues: A Scoping Study," Environmental Energy Technologies Division, Berkeley, CA, October 2011. Page 56.

³⁹ IOU engineers interviewed for this report expressed that the obligation to serve customers is paramount.

⁴⁰ CPUC Rulemaking 11-10-023, Filed October 20, 2011. Available online <http://docs.cpuc.ca.gov/PublishedDocs/Efile/G000/M031/K723/31723210.PDF>, Accessed December 13, 2012.

4.2.6 Transmission Capacity Margin

Capacity margin is the unused capacity on transmission lines based on their rated capacities. Typically, this was due to load; however, as DG penetration increases on the system, these additions could potentially positively affect the margins. Research and studies conducted on transmission line loading and how DG affects it during peak load conditions has generally concluded that the effects are minimal. The reason is that the system peak occurs late in the afternoon at the time when PV output, for example, is sharply declining. The resulting effect has resembled load shaving, but not *peak* load shaving—which utilities greatly value for reducing the needle peak in load. Interviews with IOU engineers have revealed that rather than a reduction in flows on lines, they have seen an increase in flows when DG has been installed where loads are minimal or not present. Technical analyses conducted on transmission capacities showed that impacts are minimal today, and no conclusions can be drawn due to presently low levels of DG penetration.⁴¹

4.2.7 System Stability

System stability is the ability of the bulk electric system to stay intact by staying synchronized and regaining equilibrium following a contingency on the system. This is especially important in the first few cycles and seconds when automatic generation control (AGC) responds to the loss of generation or transmission. As the proportion of variable generation with limited system response capabilities increases compared to large conventional spinning generation, it is likely that system stability may be decreased. Interviews with IOU engineers identified the need to conduct studies to determine the level of penetration that may adversely impact such issues as system stability.

4.3 SIZE AND LOCATION DEPENDENT IMPACT OF DG

In addition to all of the issues mentioned above, the size and geographic location of a DG system are important factors that may affect its impact on the transmission and distribution grid. Each of these issues is discussed separately below.

4.3.1 Size Impacts

The size of a particular DG system, relative to the distribution circuit to which it is interconnected, affects grid operations for a number of reasons. All else being equal, a smaller system has a smaller risk of having negative impacts and causing grid instability through voltage and frequency fluctuations, faults, tripping protection schemes, overloading circuits or back-feeding onto the transmission system. For distributed solar PV and wind systems, the variability of their output can be more challenging if they are larger and are serving a significant portion of the load on a specific circuit; in that case, a sudden drop or increase in output will have a proportionally larger impact on grid operation than a similar system of a smaller size.

However, it is important to note that these impacts also vary based on the distribution circuit. Distribution engineers from the IOUs indicated that some circuits may have the necessary characteristics and capacity to easily accommodate a single large DG system, while other circuits may be unable to handle more than a small amount of DG. Also, they noted that the location of the DG system along the radial distribution circuit—i.e., whether it is near the substation or at the end of the line—may be the most important factor, in combination with the amount of load in the immediate vicinity. Overall, these engineers agreed that a larger number of small DG systems would have less of a negative impact on grid operations than a smaller number of large DG systems—with

⁴¹ Itron, “Impacts of Existing Distributed Generation – Final report,” Prepared for CPUC Energy Division Staff, Davis, CA, January 2010. Pages 5-15.

the caveat that there are exceptions and each circuit has specific characteristics affecting its ability to accommodate DG.

4.3.2 Location Impacts

It is well known that the geographic locations of DG systems affect grid operations, and there are two main reasons for this. First, clustering of DG systems may pose challenges because those systems will tend to resemble a single large DG system, with the attendant issues discussed above. Though this is a potential concern, program managers for the customer-side DG incentive programs at each IOU noted that clustering is not currently happening with customer-side systems to the extent that presents a challenge for grid operations. Furthermore, the IOUs have also provided interconnection maps which direct developers of wholesale DG installations to areas where grid impacts may be smaller due to greater system capacity and less existing DG.

Second, geographic disbursement of variable DG resources like solar PV and wind reduces their short-term variability when viewed collectively. This effect is well-documented, and the impact of geographic diversity on solar output variability is discussed in a recent study by Lawrence Berkeley National Laboratory, as well as a recent paper by Clean Power Research.^{42, 43} As shown below, the output from a group of 25 PV sites spaced over a wide geographic area is considerably less variable than the output from a single site.

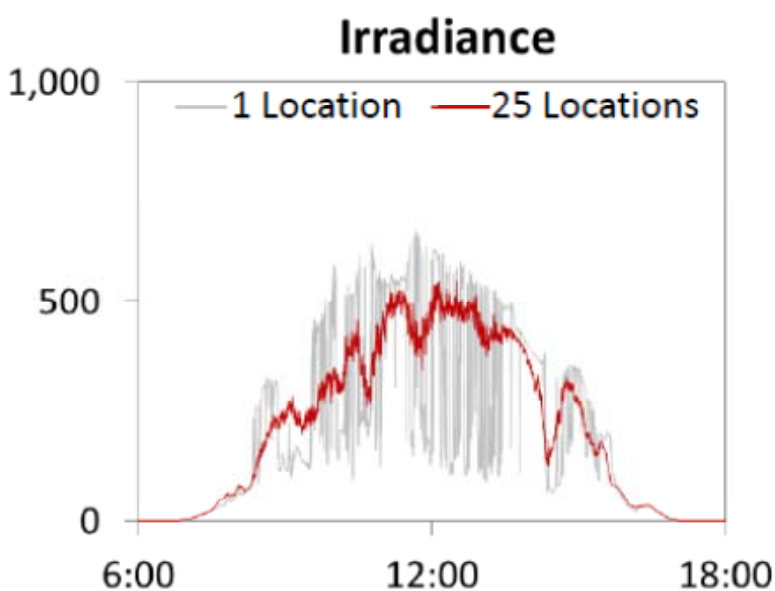

Figure 4-3 Solar Irradiance Variability – One Location vs. 25 Locations⁴⁴

Looking at both size and location impacts of DG, the literature review and interviews with utility personnel indicate that a large number of small DG systems spread over a large geographic area would generally have less of a negative impact on grid operations than a small number of large DG

⁴² A. Mills and R. Wiser, "Implications of Wide-Area Geographic Diversity for Short-Term Variability of Solar Power," Lawrence Berkeley National Laboratory, Berkeley, CA, Sept. 2010.

⁴³ T. Hoff and R. Perez, "Modeling PV Fleet Output Variability," Submitted to: *Solar Energy*, 2010.

⁴⁴ T. Hoff, "Advanced Modeling and Verification for High Penetration PV," DOE High Penetration Solar Forum, San Diego, CA, March 2011.

systems located in close proximity to each other. This is true for any type of DG technology, but is especially true for variable resources like solar and wind. While these principles may hold true, as discussed in the Barriers section (Section 5), there are currently no incentives to site DG in a manner to minimize negative impacts on the grid.

4.4 PEAK DEMAND IMPACT ANALYSIS

This section describes the impact of installed DG capacity on the peak electric demand of the California Independent System Operator (CAISO) system in 2011.

Peak demand refers to the time of day and when electric load on the grid is greatest, usually measured on a daily or annual basis. In 2011, the annual peak demand on the CAISO grid, which serves the territories of PG&E, SCE, and SDG&E, was 45,569 MW and occurred at 4:30 pm on September 7th. Since this study analyzes CAISO load and DG generation on an hourly basis, the “peak hour” in terms of CAISO demand was between 4 and 5 pm on September 7th, 2011.

In estimating the impact of the total amount of customer-side DG capacity operating on the CAISO grid during 2011 peak demand period, two separate approaches were taken for solar PV and non-solar installations. To determine the impact of solar PV capacity during the system peak demand, Black & Veatch developed a methodology that utilized actual metered data from a large sampling of solar PV systems. This analysis was undertaken in place of a CSI Impact Evaluation for 2011, in which peak demand impact has been reported in previous years. The details of the methodology and data sources used are described in Appendix B.

Black & Veatch relied on data from multiple sources to determine the total amount of DG capacity operating during the 2011 peak hour.

- For solar PV, actual production data for a large set of operating PV systems was used. The CPUC collects 15-minute interval production data from meters on hundreds of solar PV systems installed under the CSI (both EPBB and PBI) and SGIP programs. The production data was used to represent the production profile of all PV installations in the IOU territories for calculating the peak demand impact of solar. The analysis did not include the installations from the POU SB-1 programs. For a detailed description of the methodology employed, refer to Appendix B.
- For non-solar technologies, Black & Veatch used the “CPUC Self-Generation Incentive Program Eleventh-Year Impact Evaluation” prepared by Itron in June 2012. The study reported the peak demand capacity factors for non-solar SGIP generation including fuel cells, microturbines, gas turbines, and internal combustion engines (separated by renewable and non-renewable fuels). These capacity factors were the basis for calculating the amount of generation from these technologies during the CAISO peak demand in 2011. No peak hour capacity factors were provided in the report for wind turbines or advanced energy storage systems, since metered data was not available for these technologies.

The overall contribution of DG installations for the peak demand day, both solar PV and non-solar, is presented in Figure 4-4 and Figure 4-5 in terms of total MW operating in each hour. These figures display similar information with the difference between them being that Figure 4-5 shows the disaggregated impact of each program on a separate scale than the CAISO load. Figure 4-6 shows the hourly capacity factor for all DG on the peak demand day.

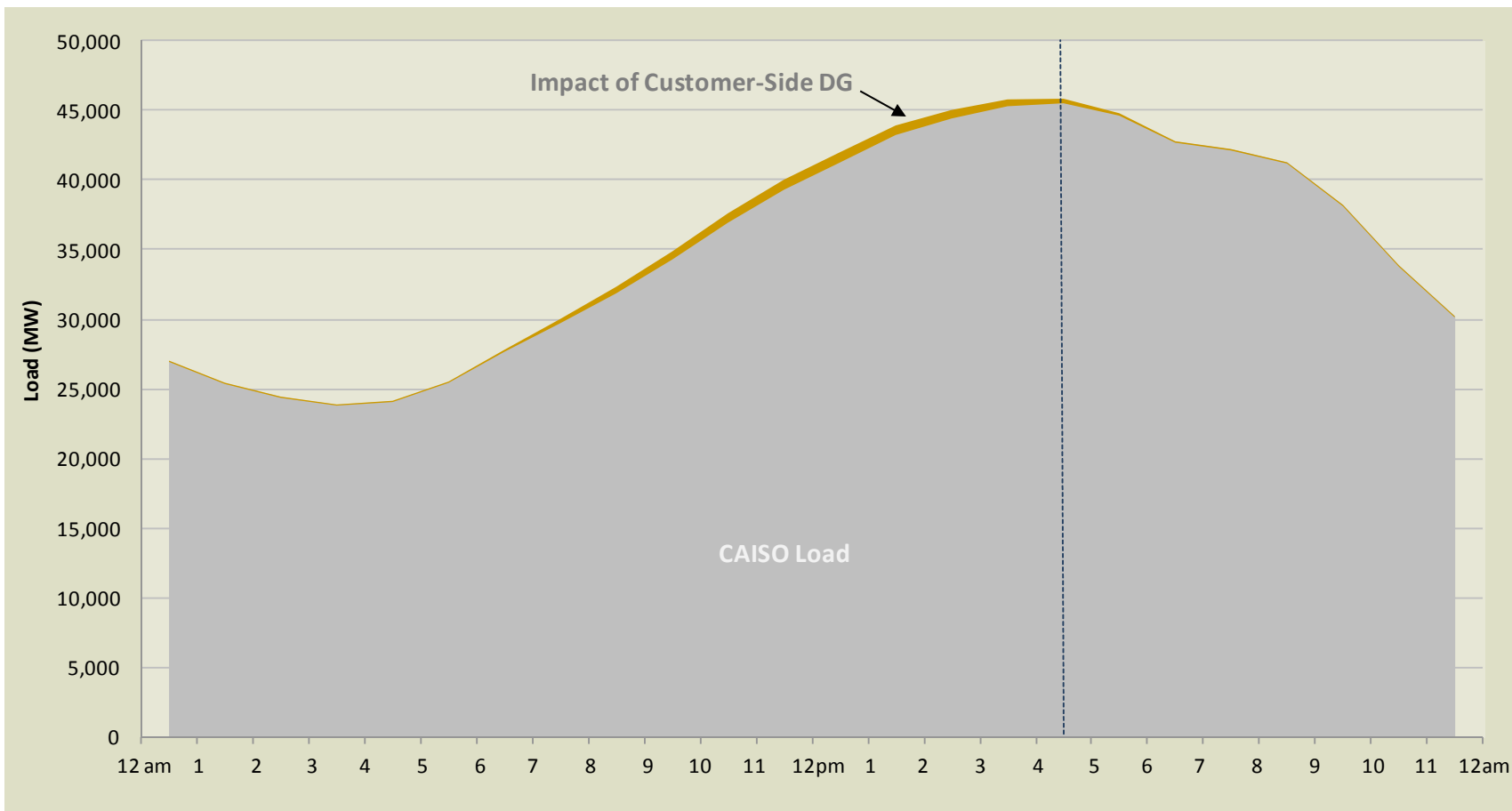

Figure 4-4 Impact of Customer-Side DG on CAISO Demand on September 7th, 2011

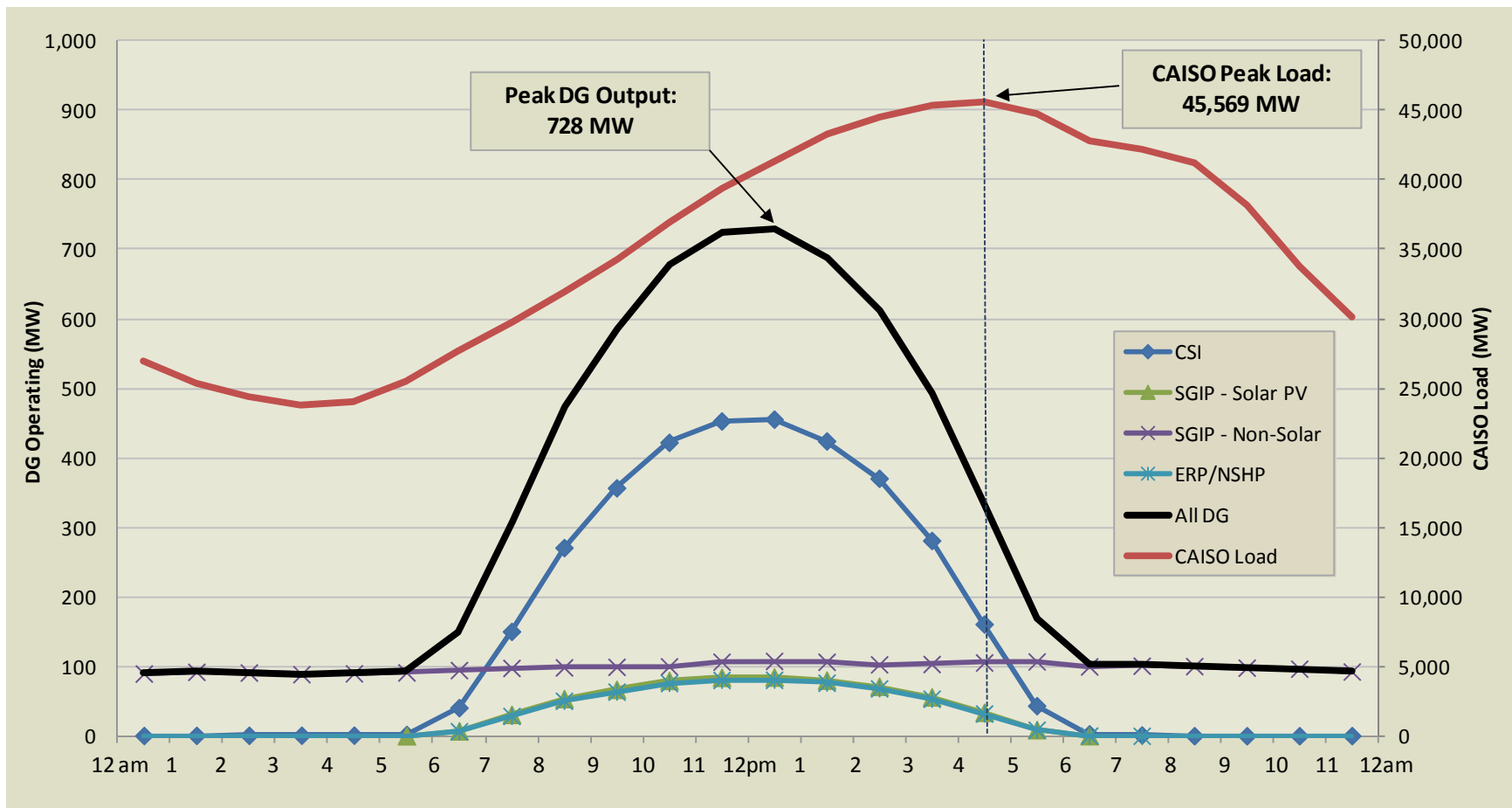

Figure 4-5 Operating DG Capacity by Program and CAISO Demand on September 7th, 2011

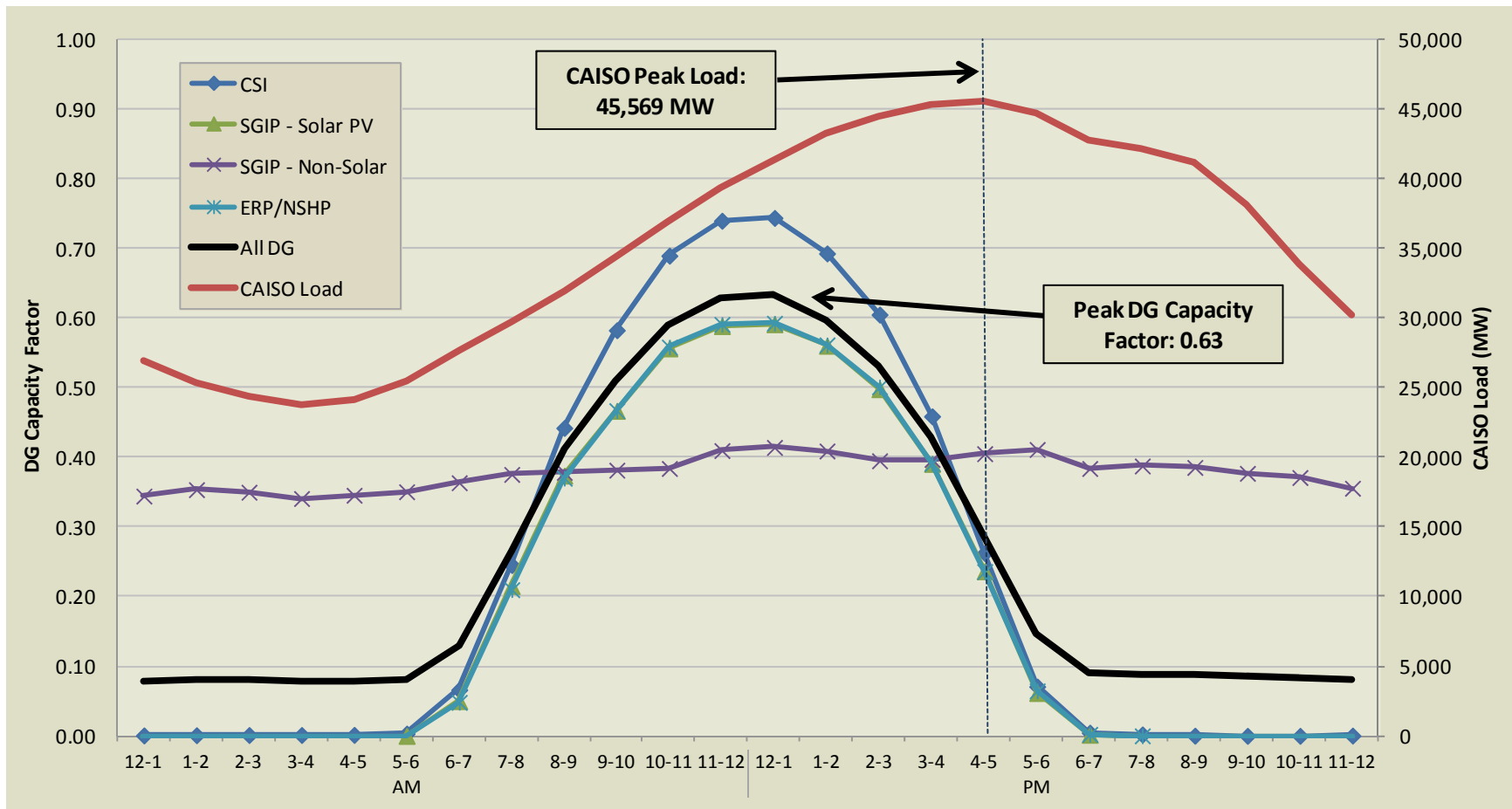

Figure 4-6 Hourly DG Capacity Factors by Program and CAISO Demand on September 7th, 2011

Overall, the peak day profile of solar PV shows that solar PV has a small but significant impact on the CAISO grid at mid-day and a less significant impact during the actual peak demand period. The non-PV technologies have a relatively constant generation profile and therefore a more consistent—though smaller—impact on CAISO demand throughout the day.

The total peak demand impact of installed DG on the CAISO grid during the 2011 peak demand period (4 to 5 pm on September 7th) was 335 MW and was approximately 0.7 percent of CAISO load. Total installed DG capacity on the CAISO grid on this date was 1,136 MW, of which 892 MW was solar PV. The detailed results are shown in Table 4-1 below, broken down by technology.

Table 4-1 Peak Demand Impact by Technology

TECHNOLOGY	MW INSTALLED	PEAK HOUR CAPACITY FACTOR	PEAK DEMAND IMPACT (MW)
Solar PV	892	0.25	227
Wind*	12	0.00	0
RF			
– FC	23	0.84	19
– MT	4	0.08	0
– GT	0	0.00	0
– IC	12	0.49	6
Non-RF			
– FC	17	0.54	9
– MT	17	0.39	7
– GT	31	0.83	26
– IC	128	0.32	41
AES*	2	0.00	0
Total	1,136	0.29	335

* No production data were available for Wind and AES installations, so they were assigned a capacity factor of zero, i.e. they were assumed to have no impact on peak demand. See Appendix B for details.

RF = Renewable Fuels; Non-RF = Non-Renewable Fuels; FC = Fuel Cells; MT = Microturbines; GT = Gas Turbines; IC = Internal Combustion Engines; AES = Advanced Energy Storage

Based on these results, Black & Veatch found that distributed solar PV contributes about 25 percent of total installed capacity during the 2011 CAISO peak demand period. Solar PV generation tends to peak around mid-day, while CAISO demand tends to peak mid to late afternoon when solar PV output is declining, as is clear in Figure 4-5 and Figure 4-6 above. Thus, the highest PV demand impact was between 12 pm and 1 pm, when distributed PV (plus other DG) provided 728 MW of capacity and accounted for 1.8 percent of CAISO load. The solar PV contribution at the time of

CAISO peak demand is about a quarter of the installed capacity rating of PV; all DG accounts for 0.7 percent of CAISO peak load from 4 pm to 5 pm.

According to Black & Veatch estimates, DG solar PV achieves an hourly capacity factor of 0.25 during the CAISO peak demand hour (4-5 pm on September 7th) in 2011. The 2010 Report estimated an hourly capacity factor of 0.65 for all DG solar PV operating during the CAISO peak demand hour (3-4 pm on June 20th) in 2008, and the 2010 CSI Impact Evaluation report estimated an hourly capacity factor of 0.56 for all DG solar PV operating during the CAISO peak demand hour (3-4 pm on August 25th) in 2010. The estimate for 2011 is significantly lower due to a number of factors. First, the CAISO peak demand came later in the day in 2011 than in 2010 and 2008—4 to 5 pm instead of 3 to 4 pm—when PV systems are producing less energy because it is closer to sunset. Also, the CAISO peak demand occurred later in the year in 2011 than in 2010 and 2008, which again means that PV systems are producing less energy; the sun is closer to setting at 4 pm in September than it is at 4 pm in June. Finally, it is possible that the peak demand hour in 2011 may have been cloudier than the peak demand hour in 2010 and 2008. All of these factors result in a lower solar PV capacity factor than in previous years.

Black & Veatch acknowledges that there are limitations to only estimating the impact of DG on CAISO peak demand. CAISO and each IOU have to plan for peak demand at a variety of levels (customer transformer, distribution feeder, distribution substation, subtransmission network, transmission substation, transmission line, the utility system, and the entire CAISO system) and this report does not attempt to model the impact of DG at every level—although that may be a useful exercise. Rather, this report seeks to show the magnitude of DG output relative to the total CAISO load because this gives a general sense of how much DG contributes to statewide peak. Future studies should conduct analysis of DG's peak demand impact at other levels because the impact is likely to be different at lower levels than at the CAISO level.

The IOUs are already conducting some research into the impact of DG at the distribution feeder level, in order to better understand these impacts and how they might change as penetration increases in the future. In particular, SCE conducted a study in October 2012 to assess the peak demand impact of customer solar PV on residential (Figure 4-7) and non-residential (Figure 4-8) feeders with above-average PV penetration rates. As shown in the figures, PV output peaks around 1pm in all cases, while load peaks around 7pm on the residential feeder and around 3pm on the non-residential feeder. While these are just selected examples, this analysis shows that while PV can have a significant impact in terms of reducing peak demand on a non-residential feeder, but it has almost no impact on a residential feeder. Results like this prove the value of examining DG impacts at the level of individual distribution feeders, because it becomes apparent that the impacts of DG depend at least as much on the localized characteristics of the distribution system as on the characteristics of the DG system itself.

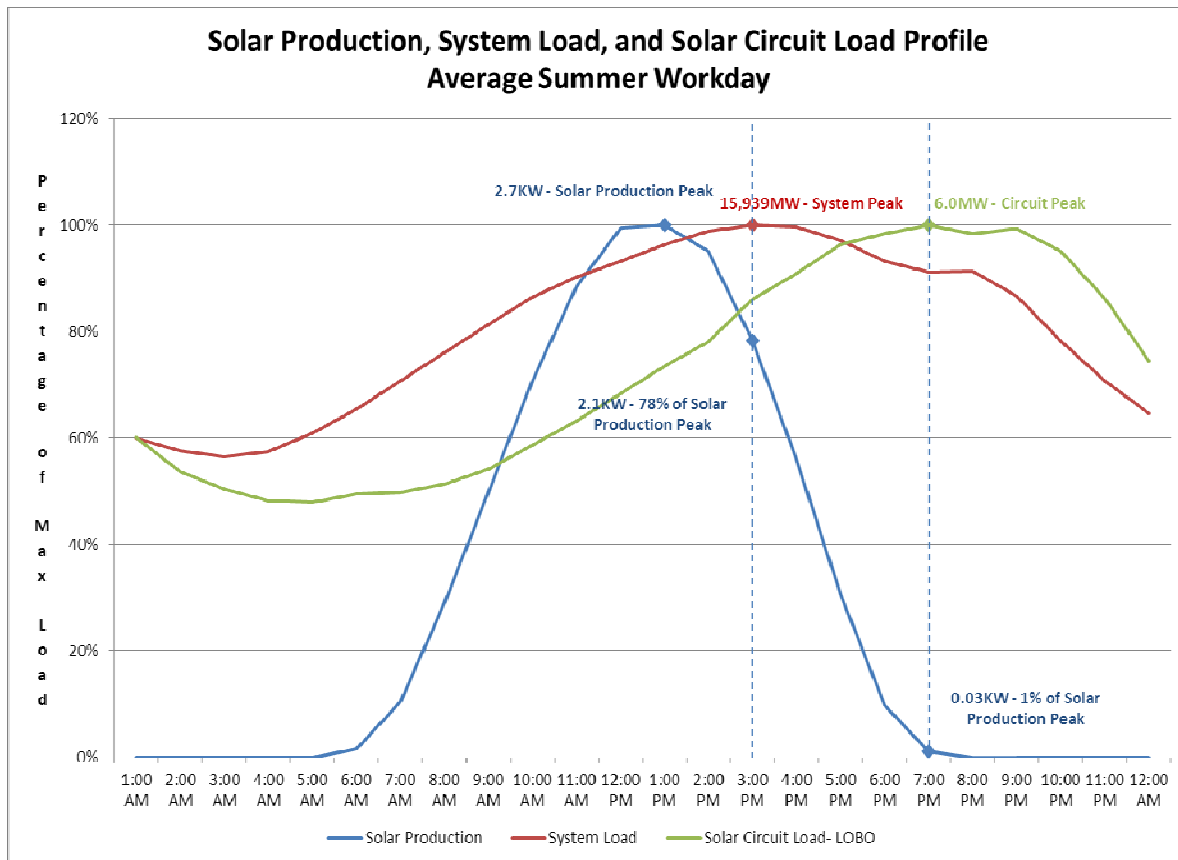

Figure 4-7 Peak Demand Impact of Solar PV on Typical SCE Residential Distribution Feeder⁴⁵

⁴⁵ “Coincidence of Solar Production with SCE’s System Load and Distribution Circuits,” SCE Load Research, Oct. 2012, p. 3.

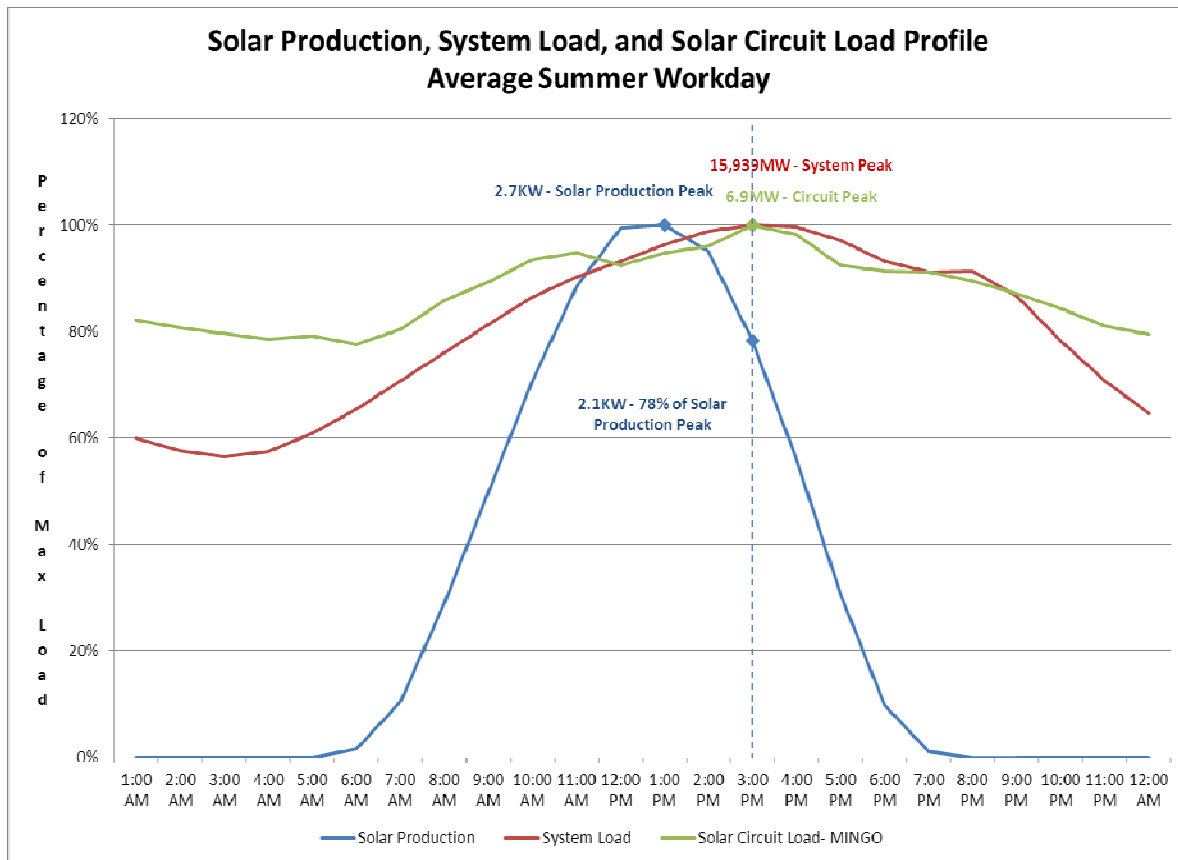

Figure 4-8 Peak Demand Impact of Solar PV on Typical SCE Non-Residential Distribution Feeder⁴⁶

Additional studies in this area of peak demand impact are warranted, even beyond the analysis of peak demand impact at levels other than the entire CAISO. The CPUC dataset containing 15-minute metered production data for CSI and SGIP systems is very large and rich. The peak demand impact analysis performed here is a simple example of its use. Previous CSI Impact Evaluation reports have performed other analyses that were beyond the scope of this report, but there are still many possible uses for the data that have not been fully explored to date. These could include:

- Extrapolation of results to determine impacts at higher DG penetrations
- Assessment of NEM systems' impact on load shape and consequential peak shifting
- Analysis of non-peak periods including identification of periods of maximum DG export
- Calculation of Effective Load Carrying Capacity (ELCC) of different DG sources. ELCC requires a statistical probability analysis of preferably multiple years of coincident load and generation data to determine the capacity value of different generation sources.
- Analysis of the impacts of west-facing versus south-facing PV systems on load shape
- Assessment of the effects of decommissioning and performance degradation on the results

⁴⁶ "Coincidence of Solar Production with SCE's System Load and Distribution Circuits," SCE Load Research, Oct. 2012, p. 5.

- Comparison and validation of different forecasting techniques
- Analysis of short-term variability of PV output by geographic location, system type, etc.
- Analysis of how much short-term variability is reduced by combining output from PV systems spread over a wide geographic area

5.0 Issues and Barriers Impacting DG Deployment

The rate of DG installations on the California grid, in particular solar PV systems, has increased significantly over the past several years. This increase can largely be attributed to financial and regulatory incentives, the availability of new leasing and financing options, the decline in solar PV costs globally, and increased marketing efforts. In many respects, California has led the nation in identifying and removing barriers to DG deployment. Initiatives such as implementation of NEM, reform of Rule 21, and completion of on-line tools for rebate processing have allowed California to successfully advance the largest DG market in the U.S. California's success has been a model for other states in implementing their own DG programs.

Despite California's success, there are still barriers to additional deployment of DG. These barriers exist from both the utility's perspective and the customer and/or developer's perspective. Moreover, there are a number of issues which affect DG deployment and merit discussion, but are not actually barriers. Barriers in this report are defined as those things which directly inhibit greater deployment of DG—as opposed to issues, which are defined here as those things which affect but do not necessarily inhibit it. This section addresses both barriers and issues.

Itron's 2010 Report identified potential barriers related to policy, technical barriers related to Rule 21, distribution system unknowns with increased penetration, and uncertainty around environmental requirements for DG. In this report, Black & Veatch provides an update and discussion of additional issues and barriers. These are listed in Table 5-1 by category, along with whether each is an issue or a barrier, and whether each is considered a key issue or barrier.

The following sections address each of these categories, and also provide a prioritized list of the key issues and barriers. It should be noted that the identification of a barrier or issue in this report does not necessarily imply that it should be, or even could be, addressed. Many barriers have already been reduced (such as interconnection issues), and some are largely outside the control of the state (such as high equipment costs). As noted in the introduction to this section, California's DG market is the largest in the country, and already has made much progress in addressing many of the larger barriers to DG.

Table 5-1 Issues and Barriers Impacting DG Deployment

CATEGORY/TOPIC	ISSUE OR BARRIER?	KEY ISSUE OR BARRIER?
Financing and Economics		
Financial Incentives	Issue	■
Access to Financing	Barrier	
Equipment Costs	Barrier	■
Soft Costs	Barrier	■
Policy and Regulatory		
Incentives to Locate DG in Beneficial Areas	Issue	■
Rate Structures	Issue	
Equitable Allocation of Costs	Issue	■
Regulatory Mandates	Issue	
Grid Access and Interconnection		
Barriers to DG Interconnection	Barrier	
Integration		
Monitoring, Forecasting, and Control	Barrier	■
Modeling Tools for Integration of DG	Issue	■
Distribution System Design	Issue	■
Inverter Standards	Issue	■
Miscellaneous		
Processing Times and Customer Understanding	Issue	■
Allocation of Funds	Issue	
Multiple Programs	Issue	
Availability of Installers	Barrier	
Marketing and Consumer Education	Barrier	
Forecasting of Future Installations	Issue	
Project Siting	Barrier	■

5.1 FINANCING AND ECONOMICS

Perhaps the most important barrier to continued customer-side DG deployment is the relatively high final cost to customers. The various incentives and programs available for installation of DG systems (described in Section 3.2.1) have encouraged widespread growth of DG throughout California. However, in the absence of subsidies, most DG technologies are currently unlikely to be competitive with grid power.

Several factors contribute to the ultimate cost of DG to customers including financial incentives, access to financing, equipment costs, and “soft” costs.

5.1.1 Financial Incentives

Because of the relatively high initial cost of DG technologies compared to grid electricity, and because public policy in California and nationwide has shown significant support for DG, financial incentives are the most immediate and direct method of reducing the cost of DG and increasing its deployment. At the state level in California, there are numerous programs which provide financial incentives for DG, as described in section 3.2.1. The NEM tariff is also a significant financial benefit for customer-side DG, because it allows customers to be credited for generation (up to their annual consumption) at the retail rate. At the federal level, the main financial incentive for DG is the investment tax credit (ITC), which provides a tax credit of up to 30 percent of the installed cost for customers who install solar PV, wind or fuel cells, and 10 percent for those who install microturbines or CHP systems.⁴⁷

Given the current levels of financial incentives offered by state and federal government, a major issue for future DG deployment is the limited, declining, or expiration of state and federal funding of incentives.⁴⁸ First, funding for many of the state incentive programs is limited, which deters later DG customers if demand for incentives outpaces availability before a program ends. Second, program funding may decrease because of outside influences (e.g. government spending cuts), or per-unit payments to customers may decline with greater participation. This latter mechanism is actually part of the design of programs such as CSI, because they assume that DG costs will decrease as more is installed and that incentive levels per kW can decrease accordingly.

Third, many current state and federal incentives are set to expire at specific points in the future, which is an issue because of the uncertainty it creates within the industry. The federal production tax credit (PTC) and investment tax credit (ITC) for wind was allowed to expire at the end of 2012, but was then extended for just one year as long as construction begins before the end of 2013. Similarly, biomass expires in 2013 and PV expires in 2016. The CSI is also set to end in 2016.⁴⁹ Other incentive programs face expiration dates as well. Due to the political nature of these programs, it is not known if any of them will be extended past their expiration date, and if they are extended it is not known how incentive levels will change. An end or significant change to these government incentives (especially the ITC) would likely reduce DG deployment since the final cost of DG to the customer could abruptly increase and a large portion of DG projects might no longer be economic. Thus, a lack of financial incentives is one of the most important potential issues for DG deployment, and also perhaps the most visible issue to customers.

⁴⁷ http://www.dsireusa.org/incentives/incentive.cfm?Incentive_Code=US02F&re=1&ee=1

⁴⁸ Energy and Environmental Economics, “California Solar Incentive Cost-Effectiveness Evaluation,” Prepared for: California Public Utilities Commission, San Francisco, CA, April 2011, p. 10.

⁴⁹ The CPUC has recently begun a market transformation study to determine what the market for customer-side solar PV will look like post-CSI.

5.1.2 Access to Financing

DG installations generally involve large upfront costs, and in the case of renewable DG like solar PV and wind, the initial capital cost is essentially the only cost (except for a small amount of maintenance over the lifetime of the system). For most customers interested in installing DG, this large upfront investment is a barrier because they may not have the required amount of cash immediately available to pay for the system, and it is much simpler and easier to continue paying their comparatively small monthly electric bill. This may happen despite the fact that in many cases they could potentially save money over the long term with a DG system.

However, over the last few years the availability of third party leasing and financing options for solar PV has helped to significantly alleviate this barrier and has allowed less affluent customers to deploy solar PV.⁵⁰ Companies offering these third party financing options often allow customers to install PV with little or no upfront investment, allowing them to simply pay a monthly charge less than their pre-existing electric bill. The prevalence of these third party arrangements has increased consistently and dramatically in the last few years, as measured by applications to the CSI program, from about 10 percent of CSI applications in 2007 to 68 percent in 2012.⁵¹ This trend is especially strong among residential customers. Figure 5-1 shows the increasing rate in each year since the CSI program began in 2007 through September 2012.

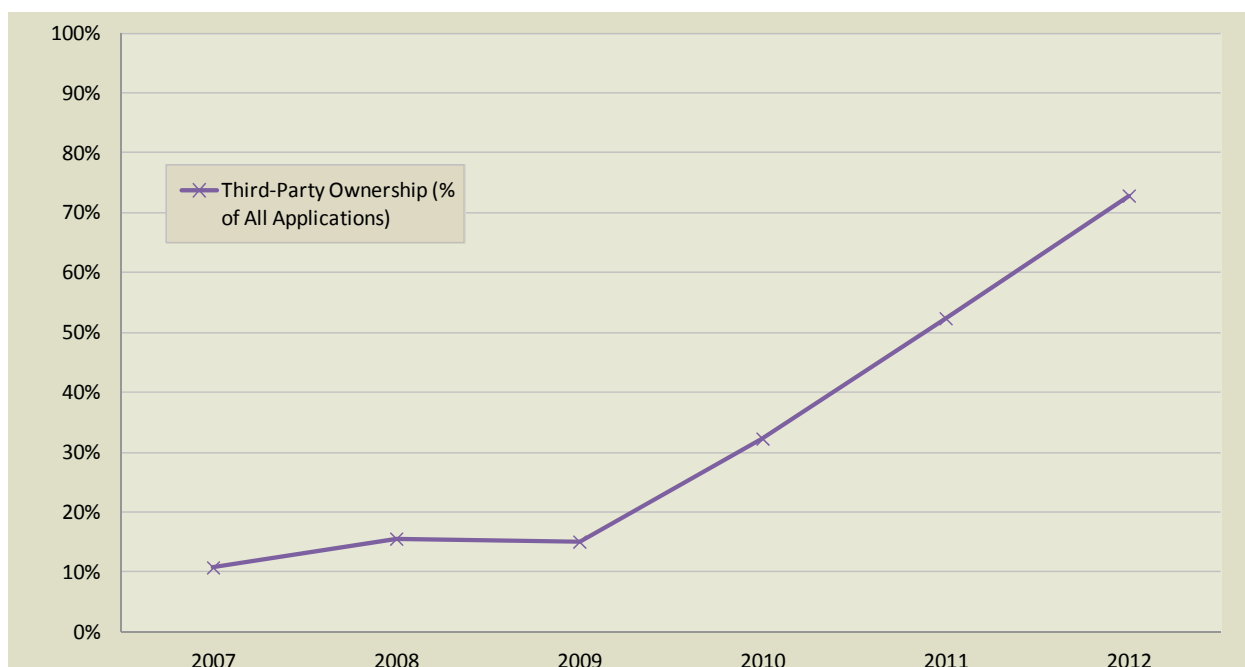

Figure 5-1 Percentage of PV Systems with Third-Party Ownership in CSI, 2007-2012

Despite the rise of leasing and other innovative financing arrangements, access to financing is still a barrier for many customers. Leasing companies prefer customers with higher electricity bills and good credit, which tend to be more affluent customers. For example, to qualify for a lease,

⁵⁰ E. Drury et al., “The Transformation of Southern California Residential Photovoltaics Market Through Third-Party Ownership,” National Renewable Energy Laboratory, Golden, CO, Jan. 2012.

⁵¹ Based on Black & Veatch analysis of the CSI Working Data Set, available at www.californiasolarstatistics.org/current_data_files.

customers of one solar leasing company must have a FICO credit score of at least 700. Just over half of the population had a score that high in 2011.⁵² While other financing structures are available, they do not offer the attractive monthly payment terms with no upfront costs.

5.1.3 Equipment Costs

Financial incentives from public programs and new financing options can help to reduce the cost of DG to customers, but the initial cost of the equipment itself is also a major factor in this cost and can be a barrier. As mentioned above, the unsubsidized costs for DG remain high relative to the cost of grid electricity; although in some cases the cost of DG equipment is declining because of increasing adoption, improving economies of scale, and technological innovation. The cost of solar PV modules, in particular, has decreased significantly in the last few years, as shown in Figure 5-2 below. But even with these declines, DG equipment costs are still one of the largest economic barriers to greater DG deployment.

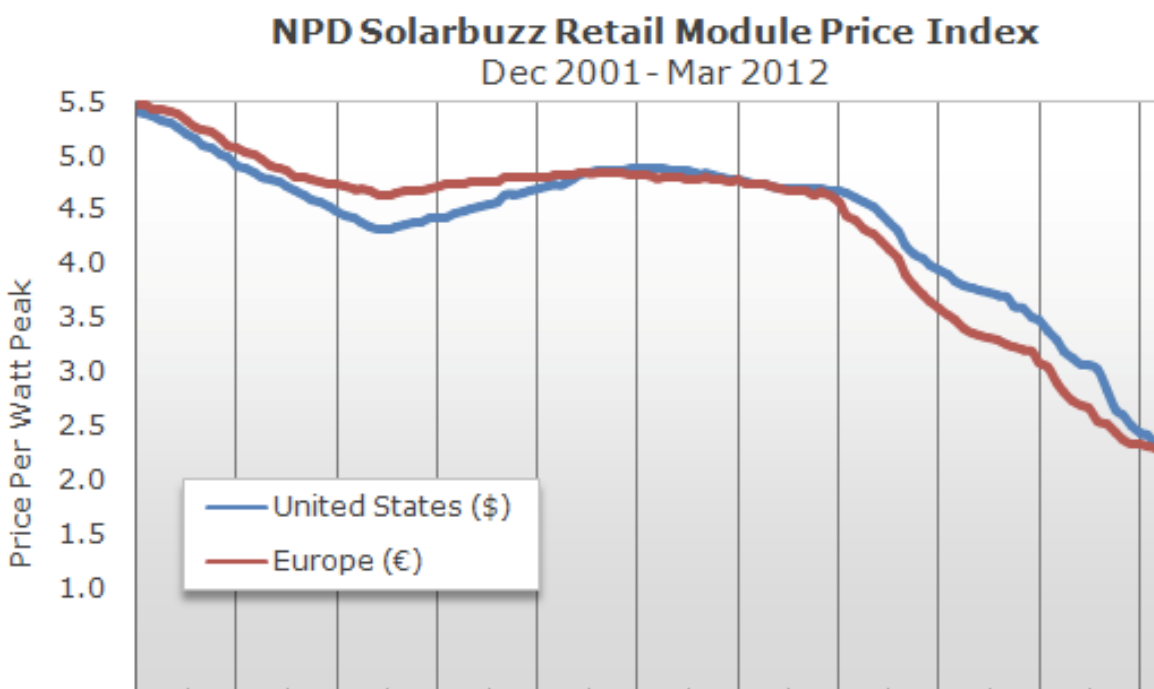

Figure 5-2 Solar Module Prices from December 2001 – March 2012⁵³

5.1.4 Soft Costs

In addition to DG equipment costs, the total cost of installing a DG system includes a number of less tangible or “soft” cost components, which in many cases can be just as significant as the “hard” costs for the physical equipment. Soft costs include any permitting fees, administrative costs, financing and contracting costs, design and engineering costs, customer acquisition costs, incentive application fees, interconnection fees, taxes, as well as the costs associated with project delays due

⁵² FICO, “FICO® Scores Shift During Recession,” <http://bankinganalyticsblog.fico.com/2011/09/fico-scores-shift-during-recession.html>, accessed September 2012.

⁵³ Solarbuzz, PV Module Price Index, available at: <http://www.solarbuzz.com/facts-and-figures/retail-price-environment/module-prices>, accessed September 2012.

to permitting or interconnection issues. DG projects in California must usually obtain approval from multiple entities or jurisdictions, including the utility to which they are interconnecting, the incentive program to which they are applying, the local jurisdiction which must inspect them for public safety reasons, and possibly other entities as well.

As equipment costs for PV have dropped, soft costs have stayed relatively constant, thus increasing their share of the overall costs. These soft costs can constitute a large portion of total DG system installed costs, and therefore are a barrier to DG deployment. Lawrence Berkeley National Laboratory released a study in September 2012 comparing the installed costs of residential rooftop solar PV installations in the U.S. and Germany.⁵⁴ The study found that average installed costs per watt in Germany in 2011 were 45 percent lower than in the U.S., mostly attributable to soft costs. Moreover, in Germany, soft costs accounted for just 20 percent of total installed costs, while in the U.S. they accounted for over 50 percent of total installed costs. The study explores a number of explanations for this difference, and indicates that the main soft cost barriers for greater solar PV deployment in the U.S. relative to Germany include:

- Smaller overall solar PV market
- Smaller average system size
- Slower project development/installation process
- Higher net-profit margins for installers due to less competition
- Higher system sales prices due to more generous subsidies and higher PV system output
- Higher customer acquisition costs, including system design costs and marketing and advertising costs
- Higher labor hour requirements for permitting, interconnection, and inspection
- Higher permitting and interconnection fees
- Higher sales taxes on PV systems

Many attempts have been made at all levels by trade associations, local permitting authorities, utilities, state agencies, legislators, and advocacy groups to reduce soft costs, with varying levels of success depending on the jurisdiction. The most significant effort in this area is the U.S. Department of Energy's Sunshot Initiative, which is seeking to reduce the installed cost of solar PV by 75 percent between 2010 and 2020. This includes a comparable decrease in soft costs, and the initiative has already funded multiple studies and projects in California.⁵⁵

5.2 POLICY AND REGULATORY

Some current governmental policies and regulations can affect the proliferation of customer-installed DG. These issues are listed below, and further described in the following subsections.

- Lack of incentives to locate DG in areas with the greatest benefit to the grid
- Certain rate structures provide differing incentives to DG
- Equitable allocation of costs and benefits

⁵⁴ J. Seel, G. Barbose, R. Wiser, "Why Are Residential PV Prices in Germany So Much Lower Than in the United States?: A Scoping Analysis," Lawrence Berkeley National Laboratory, Berkeley, CA, Sept. 2012. Available at <http://eetd.lbl.gov/ea/emp/reports/german-us-pv-price-ppt.pdf>.

⁵⁵ http://www1.eere.energy.gov/solar/sunshot/nonhardware_bos.html

- Regulatory mandates

It should be noted that changes or additions to policies and regulations will require research and close collaboration between utilities, industry, and regulators.

5.2.1 Incentives to Locate DG in Beneficial Areas

From the outset, some of the key benefits of distributed generation have been associated with their ability to be located in areas where they can reduce peak demand, reduce line losses, and defer distribution and transmission system upgrades. However, there are currently very limited incentives provided to DG system owners and developers to actually site DG in these areas. Instead, DG installations are primarily driven by other factors such as host site economics, land availability, permitting, and resource quality. Due to these overriding considerations and the lack of incentives, DG is not being optimally located on the distribution system and many of the potential benefits are not fully realized. In fact, larger DG systems routinely are faced with distribution system upgrade costs – not benefits.

As stated in a report published by Rocky Mountain Institute and PG&E in March 2012, “DG that is at the ‘right place at the right time’ will create the greatest value, while additional electricity supply in the wrong place at the wrong time could result in added costs to the system.”⁵⁶

The lack of incentives to locate DG in areas with the greatest benefit to the grid is an issues impacting cost effective deployment of DG. If California does not prioritize beneficial siting of DG, then costs to achieve the state’s DG goals are likely to be higher and benefits to consumers are likely to be lower.

5.2.2 Rate Structures

Utility rate structures can have a significant impact on the cost-effectiveness of customer-side DG installations. In some cases they may be favorable to the installation of DG, while in other cases they may deter DG. As a very simple example, customers who pay higher rates are more likely to save more from DG installation. While these customers benefit from the greater savings, to the extent there is a cost shift associated with current net energy metering policy, other customers will absorb those costs (see next section). Rate design can thus affect (1) the deployment of DG in California, and (2) impact non-DG customers and the utilities’ ability to recover costs of service. It should be noted that the intent of this section is not to assess whether certain rate designs should be encouraged or discouraged. It is beyond the scope of this report to address the impact of utility rate structures on the cost-effectiveness of customer-side DG.⁵⁷ The examples mentioned here are simply meant to illustrate specific ways in which different rate structures can affect DG deployment.

Impact of Rate Structure on DG Deployment

Rate structures, which are slightly different for each IOU, determine how a utility customer is charged for electricity usage. For residential customers of the IOUs in California, there are multiple rate tiers: up to a certain amount of usage, one rate is charged, and then a higher rate applies to usage up to the next threshold, etc. Figure 5-3 shows PG&E’s residential rate tier structure as an

⁵⁶ “Net Energy Metering, Zero Net Energy, and the Distributed Energy Resource Future: Adapting Electric Utility Business Models for the 21st Century,” Rocky Mountain Institute, Snowmass, CO, March 2012.

⁵⁷ The CPUC has opened a rate design rulemaking to comprehensively examine utility rate structures. Order Instituting Rulemaking on the Commission’s Own Motion to Conduct a Comprehensive Examination of Investor Owned Electric Utilities’ Residential Rate Structures, the Transition to Time Varying and Dynamic Rates, and Other Statutory Obligations, R.12-06-013, Issued June 21, 2012.

example. Customers in the highest tier pay a much higher rate per kWh than customers in the lower tiers. As shown in the figure, at almost \$0.35/kWh, the Tier 4 rate is about three times higher than the Tier 1 rate. Thus, high-usage customers have greater economic incentive to pursue DG options than customers in lower tiers. If the residential rates were structured differently—e.g. if the per-kWh rate were the same for all customers regardless of usage—the adoption rate of DG by various types of customers would likely be different. In today’s rate structure, the lower rate paid by customers in the lower tiers may be acting as a deterrent, if such customers may be interested in installing DG but are not able to justify it compared to their low per-kWh rate. Of course, equalizing the tiers would also run counter to other policy goals, such as encouraging energy efficiency.

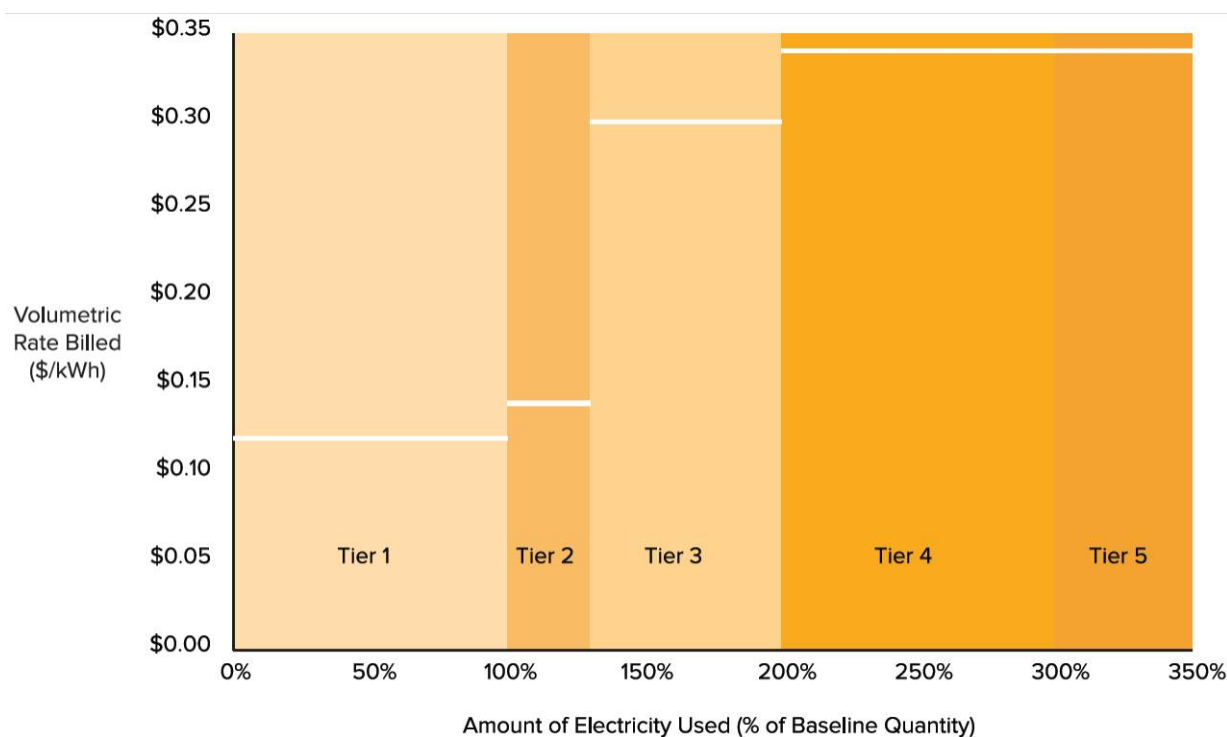

Figure 5-3 PG&E Residential Rate Tier Structure (January 2012)⁵⁸

For commercial and industrial customers, the situation is more complicated. In addition to the per-kWh energy charge there also can be a “demand charge” paid based on the individual customer’s peak demand. The peak demand is measured as the highest average usage over a 15-minute period out of the month. Placing a charge on peak demand is meant to cover some of the costs of the infrastructure to serve these customers; it also gives these larger customers an incentive to reduce their peak demand. The demand charge can be a significant portion of the customer’s electric bill if the customer has high peak energy use.

According to CCSE, the different non-residential tariffs for the IOUs shift varying amounts of the customer’s overall costs between the demand charge and the per-kWh charges, but PG&E and SCE

⁵⁸ “Net Energy Metering, Zero Net Energy, and the Distributed Energy Resource Future: Adapting Electric Utility Business Models for the 21st Century,” Rocky Mountain Institute, Snowmass, CO, March 2012.

have tariffs that shift more costs to the per-kWh charge than SDG&E.⁵⁹ This means that commercial customers in SDG&E territory have less of an economic incentive to install distributed solar PV. Even though they may be able to reduce their per-kWh costs with PV, they still have to pay a relatively larger demand charge (compared to PG&E and SCE territories) which DG may not help to reduce, since PV may not peak when the customer's demand peaks. As with the residential rate tiers mentioned above, if the relative distribution of demand charges and kWh charges were adjusted for commercial/industrial IOU customers, then the adoption of DG would likely change.

Figure 5-4 shows the impact that different rate structures can have on electric bills for customers in SDG&E's territory. The chart shows compares examples of monthly bills for a commercial customer under three scenarios:

- "Bills Before PV Installation" shows a typical billing history for a commercial customer without any DG on the standard rate.
- "Bills After PV, on TOU Rate" shows the billing history for a commercial customer with solar PV on a typical time-of-use rate that includes a significant demand charge (Rate: AL-TOU).
- "Bills After PV, on DG Rate" shows the billing history for a commercial customer with solar PV on a modified rate that includes a much lower demand charge (Rate: DG-R).

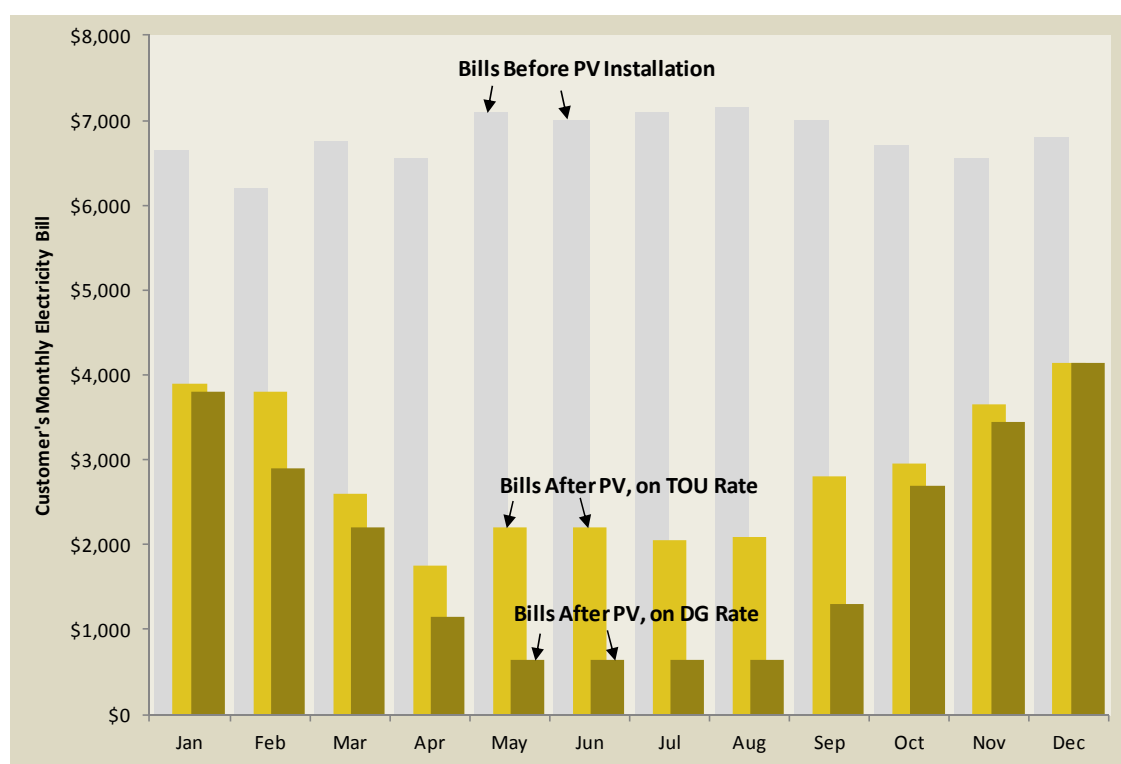

Figure 5-4 Example Impact of Rate Structures on SDG&E Customer Electric Bills.⁶⁰

⁵⁹ For example, PG&E's A-6 tariff for small general time-of-use service does not have a demand charge. Its energy rate for summer peak periods is \$0.44/kWh. See http://www.pge.com/tariffs/tm2/pdf/ELEC_SCHS_A-6.pdf.

⁶⁰ J. Del Real and J. Fortune, "Understanding Non-Residential Utility Rates," California Center for Sustainable Energy, May 2010.

A customer with PV on any type of rate will have lower electric bills than the “Bills before PV Installation”, because the PV generation is offsetting consumption from the grid; thus, both “Bills After PV” bars are lower than the “Utility Bill without PV” bar in every month. But it is clear from the difference between the rates with PV (i.e. the difference between “Bills After PV, on TOU Rate” and “Bills After PV, on DG Rate”) that the DG rate with lower demand charges results in a lower bill, especially during the summer months when PV production is greatest and demand charges are highest. This lower bill will reduce the payback time for the PV system, and it illustrates that the value of DG to the customer can be significantly affected by the rate structure.

Impact of Rate Structure on Cost of Service Recovery

While a lower utility bill will result in a reduced payback time for the PV system, it may also hinder the IOUs’ ability to recover the costs of providing electric services to residential and other customer classes who install self-generation. This is because costs of service (i.e. the infrastructure that allows DG customers to reliably consume electricity from, and export to, the utility grid) are embedded in energy (kWh) related charges for certain customer classes. If the utility is unable to fully recover costs from self-generators, nonparticipating customers may have to absorb those costs, which could affect their rates. SDG&E indicated that a worst-case situation could arise when rates increase due to greater DG deployment, and more customers then become incentivized to install their own DG system, which could further exacerbate the rate increases, creating an unsustainable feedback loop.

5.2.3 Equitable Allocation of Costs

Distributed generation systems receive various incentives through the programs described in this report. Ultimately, all ratepayers and taxpayers fund these incentives, whether they are participants and non-participants, even though only a relatively small portion of the population currently participates in these incentive programs. While non-participants receive some benefits, such as reduction of greenhouse gas emissions, these benefits may not exceed the costs paid. If there is concern that cost allocation is non-equitable, this may affect continued proliferation of DG.

Another example of non-equitable cost allocation relates to distribution system upgrades that may be required to install DG. As discussed in section 4.1, protection schemes may need to be modified, additional equipment may be required, or system modifications may be needed. The allocation of costs for these new requirements may fall inequitably on all rate payers, including those who do not benefit directly from the upgrade.⁶¹ Under current law, NEM projects pay little to no cost to interconnect to the utility grid.⁶² From the utilities’ perspective, there is concern that with increased DG and NEM installations, additional upgrades to the distribution system may become necessary. The costs of these upgrades would be borne by the utility and passed on to all ratepayers, meaning that non-NEM customers would effectively be subsidizing the NEM customers. This issue is made more complex by the fact that customers who install DG and take advantage of the NEM tariff tend to be wealthier than the average ratepayer, so poorer customers would be subsidizing wealthier ones in this scenario.⁶³ The equitable allocation of costs between NEM customers and other

⁶¹ Itron, “Impacts of Distributed Generation,” Prepared for: California Public Utilities Commission Energy Division Staff, Davis, California, January 2010, p. 4-5.

⁶² This exemption for NEM projects derives from Pub. Util. Code § 2827(d) and was interpreted by the CPUC in D.02-03-057 to include exemptions from the costs of interconnection application review fees, interconnection studies, and distribution system modifications triggered by the NEM project.

⁶³ “Net Energy Metering, Zero Net Energy, and the Distributed Energy Resource Future: Adapting Electric Utility Business Models for the 21st Century,” Rocky Mountain Institute, Snowmass, CO, March 2012, p. 32.

ratepayers is considered by utilities to be a major concern for increasing DG deployment, and is currently being studied by the CPUC.

Past studies and new initiatives are underway to try to address this issue. These have shown mixed results: some indicate there are significant subsidies for NEM customers, while others indicate there are significant net benefits for all ratepayers. The NEM Cost-Effectiveness Evaluation completed for the CPUC in March 2010 found that all NEM PV installations through 2008 resulted in a levelized cross-subsidy of approximately \$20 million per year. SCE in 2012 completed a study that estimated that NEM customers are subsidized by non-NEM customers around \$50 million per year with NEM capacity at about one percent of system peak demand.⁶⁴ Conversely, a study completed by Crossborder Energy on behalf of the Vote Solar Initiative in January 2013 estimated that when NEM PV capacity reaches five percent of peak demand in California it will provide approximately \$90 million per year in net benefits to ratepayers of PG&E, SCE and SDG&E; it found that most of those net benefits would result from non-residential NEM installations.⁶⁵ It is expected that the updated NEM Cost-Benefit Evaluation for 2012-2013, commissioned by the CPUC, will address this issue again and provide greater detail.⁶⁶ Finally, the University of San Diego Energy Policy Initiatives Center, Black & Veatch, and Clean Power Research are currently conducting a cost-benefit study focused on the net cost or benefit of solar PV NEM systems in SDG&E's territory. An objective of that study is to determine the cost of the services provided to NEM customers and the value of the benefits they provide to the system.

5.2.4 Regulatory Mandates

CPUC, FERC and other regulating bodies apply certain operational mandates to utilities. Input from the IOUs indicated that mandates that are difficult to implement or limit a utility's operations can unintentionally affect further DG deployment. For example, SDG&E indicated that the unique attributes of their system, specifically being heavily residential, are not often considered by regulators and could impact further deployment of DG.

As another example, the CPUC requires utilities to maintain voltage at a certain standard (for example, within a +/- 5 percent threshold).⁶⁷ As described in section 4.1.5, DG systems affect system voltage, and may lead to violations of the CPUC mandated thresholds. Thus, it is possible that these standards could indirectly affect DG deployment by discouraging installations which may cause voltage issues. PEPCO Holdings, Inc, which is dealing with increased solar PV installations in New Jersey, has suggested that voltage standards might be reviewed and potentially relaxed to provide greater flexibility to accommodate DG in its service territory. In particular, Germany applies a +/- 10 percent threshold.⁶⁸ However, relaxing voltage requirements would need to be carefully considered and may not be appropriate in California. Operating at higher voltage may be detrimental to existing customer load equipment that was designed and rated for the existing voltage range.

⁶⁴ SCE, "Retail Rates and Cost Issues with Renewable Development," May 2012, available at http://www.energy.ca.gov/2012_energy/policy/documents/2012-05-22_workshop/presentations/09_Garwacki_SCE-Retail_Rate_2012-05-22.pdf.

⁶⁵ Crossborder Energy, "Evaluating the Benefits and Costs of Net Energy Metering in California," January 2013. Available at: <http://votesolar.org/resources-impacts-of-net-metering-in-california/>.

⁶⁶ http://www.cpuc.ca.gov/PUC/energy/Solar/nem_cost_benefit_evaluation.htm

⁶⁷ Voltage and other service standards are set out in each IOU's Electric Tariff Rule 2, which is subject to the CPUC's approval.

⁶⁸ PEPCO Holdings, Inc., "Challenges for Distribution Feeder Voltage Regulation with Increasing Amounts of PV", Available at: http://www1.eere.energy.gov/solar/pdfs/hpsp_grid_workshop_2012_steffel_pepco.pdf.

5.3 GRID ACCESS AND INTERCONNECTION

Challenges in obtaining access to the distribution grid and completing the utility interconnection process are often cited as barriers for DG deployment. California has made large strides in facilitating DG interconnection. This section describes existing interconnection processes, barriers related to interconnection, and future interconnection policies that may affect these barriers.

5.3.1 Existing Interconnection Processes

There are three different interconnection processes that apply in California, depending on project size and whether the interconnection is to the transmission or distribution system. Although this report does not focus on wholesale DG systems, the interconnection processes for these systems are summarized in addition to customer-side DG below.

CAISO Interconnection Process

Wholesale DG projects may in some cases be large enough to interconnect with the transmission system. If this were to be the case, they would go through the CAISO interconnection process, which has four tracks, listed in order from simplest to most complex:

- 10 kW Inverter Process
- Fast Track Process
- Independent Study Process
- Standard Cluster Study Process

Wholesale Distribution Access Tariff Process

If a wholesale DG project is to interconnect with the distribution system of an IOU and engage in competitive wholesale commercial arrangements, then it would likely go through the interconnection process set out in each IOU's Wholesale Distribution Access Tariff (WDAT), which is similar but not identical for each IOU. There are multiple tracks within the WDAT process similar to the CAISO tracks listed above.⁶⁹ Each IOU's WDAT is a FERC-jurisdictional tariff.

Rule 21 Process

Customer-side DG systems interconnecting with the distribution system and wholesale DG engaging in an avoided-cost sale to the host utility, such as feed-in tariff participants, will typically use the CPUC-jurisdictional Rule 21 interconnection tariff. Rule 21 was initially adopted by the CPUC in 1982 to address the safe and reliable interconnection of Qualifying Facilities (QFs) under the Public Utility Regulatory Policies Act (PURPA). The CPUC revisited Rule 21 in 2000 and worked to substantially streamline the interconnection process for smaller, customer-side DG systems, especially NEM systems. The changes were effective: to date, as shown in Table 3-9 above, over 100,000 NEM systems have been successfully interconnected.

However, as the scale and penetration of DG systems have increased, particularly with the advent of the CPUC's newer wholesale DG programs, additional reforms to facilitate interconnection became necessary. Significant reforms to Rule 21 enacted in September 2012 are designed to make the interconnection process more timely, cost-effective, and transparent for wholesale DG projects while retaining the same efficiency for NEM projects.

⁶⁹ CAISO, "Resource Interconnection Guide," July 2012. Available at <http://www.caiso.com/participate/Pages/ResourceInterconnectionGuide/default.aspx>.

To serve DG interconnecting to the distribution system on both sides of the meter, the Rule 21 interconnection process involves the following study tracks, also listed in order of simplest to most complex:

- Fast Track Process
- Detailed Studies
 - Independent Study Process
 - Distribution Group Study Process (forthcoming)⁷⁰
 - Transmission Cluster Study Process⁷¹

Additional recent reforms to Rule 21 include:

- Eligibility for the “Fast Track” process is expanded to include exporting facilities up to 3 MW for PG&E and SCE, and up to 1.5 MW for SDG&E.
- Eligibility for DG penetration levels is expanded to the highest in the nation. The initial screen for aggregate generating capacity up to 15 percent of peak line section load is retained; however, if an applicant fails this screen, the aggregate generating capacity may alternatively be tested against 100 percent of minimum load on the line section. This should allow for more DG to be connected within the Fast Track process.
- Energy storage is included within the definition of “generating facility,” making storage technologies eligible for the same interconnection process within Rule 21.
- Standard Interconnection Agreements for NEM, non-export, and exporting generating facilities are approved.
- Standard application and supplemental review fees (NEM systems exempt from these fees) are approved.
- Firm timelines are established to ensure that projects make progress toward interconnection.
- Dispute resolution mechanisms at the IOUs and at the CPUC are established to address interconnection-related disputes efficiently.
- A process for obtaining Resource Adequacy value is identified through the Transmission Cluster Study Process.
- A pre-application report and online interconnection queues are introduced to aid siting decisions.

⁷⁰ The Distribution Group Study Process is intended as a more-efficient study track for groups of electrically interdependent generating facilities interconnecting to the same distribution circuit. The CPUC has identified this additional study track within Rule 21 as an issue to be completed within Phase 2 of the interconnection OIR. See Assigned Commissioner’s Amended Scoping Memo and Ruling Requesting Comments, filed September 26, 2012 in R.11-09-011.

⁷¹ Applicants under Rule 21 that are found to have electrical interdependence with the transmission network are offered the option of transitioning to the next applicable transmission cluster study process conducted by CAISO.

5.3.2 Barriers Related to DG Interconnection⁷²

The CPUC's interconnection oversight and reform efforts have focused on Rule 21, the tariff under the CPUC's jurisdiction. It is important to note that the reforms to Rule 21 adopted in September 2012 were intended to address a number of barriers to entry related to timeliness, transparency, and predictability that had been identified before the start of the CPUC's interconnection rulemaking. Thus, the CPUC will be monitoring the success of the reforms in reducing or eliminating those barriers to entry.

At the same time, the CPUC has identified certain forward-looking interconnection policies to address in Phase 2 of the interconnection proceeding. Those include:

- Detailing the Distribution Group Study Process,
- Developing additional standardized interconnection forms and agreements,
- Enhancing interconnection cost certainty, using tools such as the identification of preferred locations for DG,
- Evaluation of the success of Rule 21 in reducing interconnection as a barrier to entry, and
- Evaluating technical operating standards that can aid in accommodating increases in DG, including autonomous smart inverter functionalities.⁷³

Time to Process Interconnection Applications

The efficiency and speed with which interconnection applications are processed under Rule 21 has been identified as a barrier by some, since the amount of DG installed is completely determined by how much DG is approved for interconnection by the utility. Some point to the fact that interconnection process is paper-based as a source of inefficiency. To help address this issue, SDG&E has implemented an online database for interconnection applications, similar in some ways to the PowerClerk software used by the CSI program for incentive applications. This has improved application processing speed and allowed greater customer visibility into the interconnection approval process, thereby reducing the perception of interconnection processing as a barrier to DG. However, the funding for such efforts may have to be drawn from the budget for other activities like operations and maintenance, which is a barrier on the utility side to further improvements.

Table 5-2 and Figure 5-5 show the average times taken to process interconnection applications for distributed solar PV in the CSI General Market program by each IOU. All of the IOUs are on average meeting their statutory obligation to process NEM interconnection applications within 30 days. For both residential and non-residential applications, SDG&E showed significantly shorter processing times than PG&E and SCE. While SDG&E has a smaller volume of interconnection requests, representatives from CCSE indicated that SDG&E focuses on completing interconnections quickly and that its online interconnection database also makes the process more efficient than the other utilities' paper-based systems. Since nearly all of these applications are for DG solar systems that are also receiving incentives, the interconnection application processing time is merely one part of the process that can cause delays. However, it is perhaps the most critical part because a customer

⁷² As noted previously, California has successfully addressed many interconnection barriers in the past, and many additional barriers have been addressed through the reforms to Rule 21. This section describes issues which have historically been considered barriers, but which may no longer represent significant obstacles to DG interconnection.

⁷³ Assigned Commissioner's Amended Scoping Memo, filed September 26, 2012 in R.11-09-011.

cannot legally interconnect to the grid and start producing electricity without completing the interconnection process.

Notably, the average interconnection application processing time for all three IOUs increased in the first 6 months of 2012 compared to previous years. A probable explanation for the increase is the increased volume of interconnection requests. Compared to previous years, the rate of interconnection applications has substantially increased, in some cases doubling. Adding staff and implementing an online processing system may decrease the average interconnection processing time.

Table 5-2 Number of Interconnection Applications and Average Interconnection Application Processing Times for CSI PV Systems by IOU⁷⁴

TIME PERIOD	PG&E		SCE		SDG&E	
	RESIDENTIAL	NON-RESIDENTIAL	RESIDENTIAL	NON-RESIDENTIAL	RESIDENTIAL	NON-RESIDENTIAL
Average Number of Applications Received per Month						
January – June 2012	798	63	889	38	273	8
2009 – 2011	726	36	453	19	200	6
Average Processing Time (Days)						
January – June 2012	18.4	17.6	12.3	19	4.5	6.9
2009 – 2011	10.7	12.6	10	17.9	3.6	4.8

⁷⁴ http://www.californiasolarstatistics.ca.gov/reports/data_annex/ and CSI Working Data Set

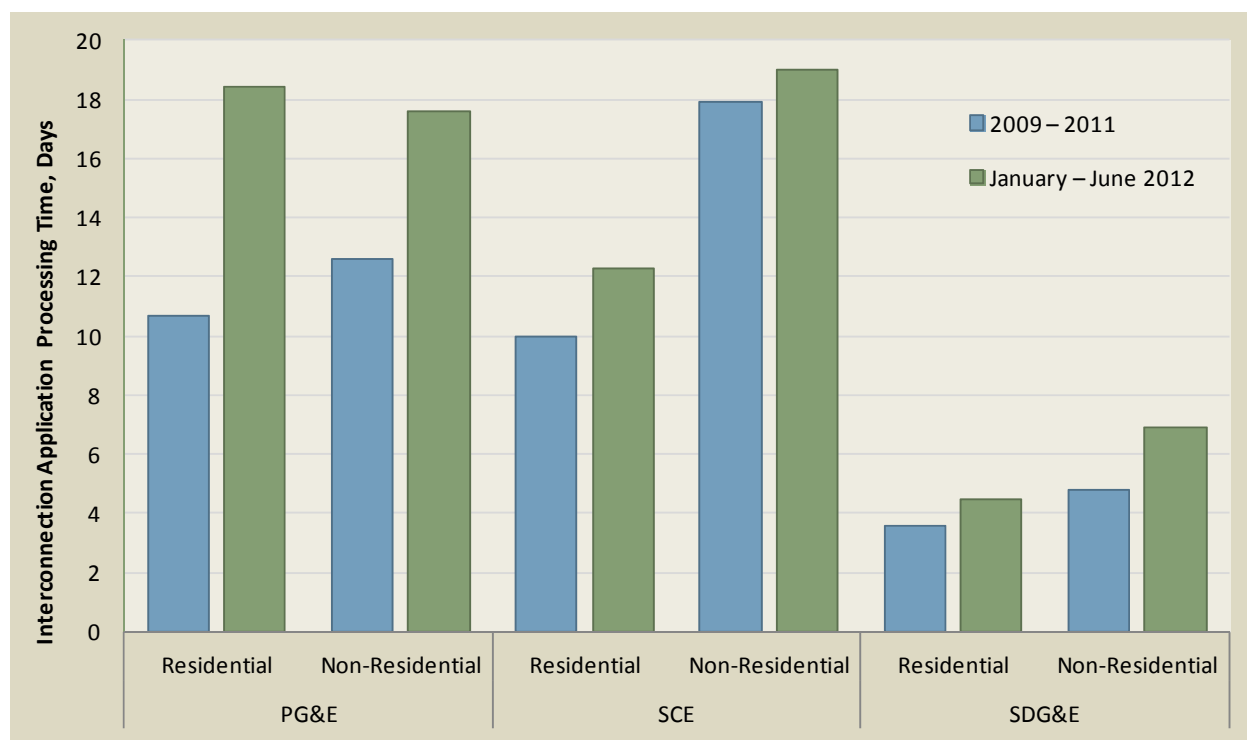

Figure 5-5 Average Interconnection Application Processing Times for CSI PV Systems by IOU

Identifying Optimal Interconnection Locations

As has been noted throughout this report, identifying the “right place at the right time” for DG will create the greatest value for ratepayers and the electric grid. Achieving this goal has direct implications for interconnection. First, as discussed in this section, there are several tools now available in California to aid DG siting decisions. Second, the CPUC is considering next-generation policies, such as improving interconnection cost certainty and autonomous smart inverter functionalities, to further identify the optimal locations and timing of DG on the distribution system.

Interconnection Capacity Maps

Installers and developers in the past often noted that it would be helpful to have a map or GIS tool which would allow them to identify optimal locations on the distribution system for larger DG systems (generally wholesale systems) based on circuit capacity or other characteristics, rather than having to find out which sites are good or bad through the interconnection review process. Fortunately, this particular barrier has been at least partially addressed for wholesale systems, and is generally not a challenge for customer-side systems. In 2011, pursuant to CPUC decisions implementing the RAM program, the IOUs released web-based maps of interconnection capacity on their distribution and transmission systems for just this purpose (see Figure 5-6). Pursuant to CPUC orders, the IOUs actively maintain these maps on their websites and update them approximately once per month.

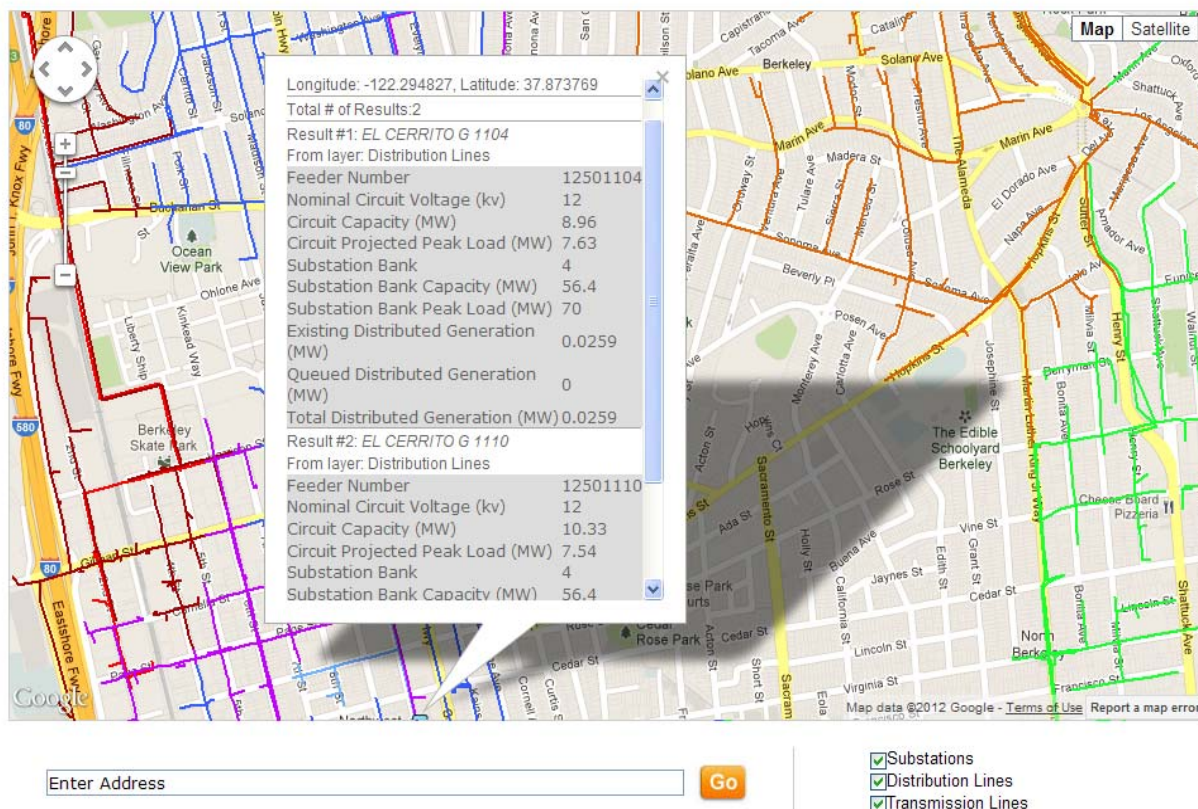

Figure 5-6 Example Interconnection Capacity Mapping Tool from PG&E⁷⁵

Pre-Application Report and Online Integrated Queues

In addition to the maps, a Pre-Application Report is now available under Rule 21, which provides a low-cost (\$300) first look of the technical potential and challenges of a desired point of interconnection for a DG project. Any potential applicant can request a report, regardless of whether they will apply for interconnection under Rule 21 or the Wholesale Distribution Access Tariff.

Rule 21 also now requires IOUs to maintain an online integrated queue of the DG projects seeking interconnection to the distribution system under Rule 21 and the FERC-jurisdictional Wholesale Distribution Access Tariff. This online spreadsheet provides market participants a means of evaluating the number of applicants queued ahead on the same distribution circuit. The length of the queue impacts the time and risk associated with the interconnection process.

5.3.3 Future Interconnection Policies

Because of the increasing amount of DG and the growing focus on its role in the electric system, efforts to develop the next generation of interconnection-related policies are underway at both the state and federal level.

⁷⁵ <https://www.pge.com/b2b/energysupply/wholesaleelectricsuppliersolicitation/PVRFO/PVRAMMap/index.shtml>

CPUC Rule 21 Initiatives

Cost certainty has been identified as a major factor affecting the ability of DG installers to complete the interconnection process. Cost uncertainty can take the form of a lack of predictability about the upgrades and costs that will be triggered at a given point of interconnection, and/or a high degree of variability in triggered costs during the interconnection process, because of decisions made by queued-ahead projects.⁷⁶ The CPUC held a first workshop on cost issues in November 2012 to launch Phase 2 of the interconnection proceeding.

As discussed further in Section 6 below, DG has the potential to support, rather than detract from, the reliability of the grid. In Phase 2 of the interconnection proceeding, the CPUC is examining the potential to introduce autonomous smart inverter functionalities that would be applicable to certain DG systems. The potential for contributions by DG with smart inverter functionalities is discussed further in Section 5.4 and Section 6.0.

CAISO DG Initiatives

Also at the state level, CAISO issued a memorandum in September 2012 for the consideration of its board, covering CAISO's evolving policies to address increasing DG deployment in California.⁷⁷ This memorandum includes a number of initiatives, all of which are designed to facilitate the interconnection of DG on the transmission and distribution system:

- A streamlined assessment process for DG projects requesting deliverability status to support resource adequacy procurement for 2014
- A review and stakeholder process related to complex and costly telemetry and metering requirements for DG projects
- A “non-generating resource” model to allow energy storage projects to participate in the CAISO market
- A clarification that energy storage can provide both spinning and non-spinning reserves for the grid

FERC DG Initiatives

At the federal level, FERC is currently considering a petition for rulemaking filed by the Solar Energy Industries Association (SEIA) in February 2012. This petition requested that FERC revise its small generator interconnection procedures to make it easier for distributed solar PV to be interconnected to the distribution grid using the “fast-track” review process, largely by raising the project size limits and by introducing the alternative DG penetration limit of 100 percent of daytime minimum load now available in Rule 21. FERC held a technical conference in July 2012 to discuss this particular issue, at which the CPUC presented the new penetration threshold and other relevant advances that were then pending (and since approved) in Rule 21. As of this writing, FERC has not yet reached a decision about whether to act on SEIA's petition. While it is not certain that FERC can adopt SEIA's proposed changes because they are solar-specific (FERC must remain technology-neutral in its policies), the fact that the petition is being considered shows that there may be change at the federal level in terms of interconnection processes related to DG, and that regulatory changes may reduce barriers to greater DG deployment.

⁷⁶ For more on the cost issues associated with interconnection, see Assigned Commissioner's Amended Scoping Memo and Ruling Requesting Comments, filed September 26, 2012 in R.11-09-011.

⁷⁷ K. Edson, “Briefing on Distributed Energy Resources,” submitted to CAISO Board of Governors, Sept. 2012.

5.4 INTEGRATION

The integration of DG into the distribution system and the overall operation of the utility's grid is a challenge. Many DG systems, predominantly those which implement wind or solar technology, do not have the ability to supply generation on demand. As DG penetration increases, particularly on the same distribution feeder, the integration of DG systems will become more challenging.

There are several challenges to integrating DG systems to the transmission and distribution grid, particularly intermittent systems such as solar or wind facilities. These issues and barriers are listed below, and are further described in the following subsections.

- Lack of monitoring, forecasting and control capabilities
- Lack of modeling capabilities to address increased integration of DG
- Distribution system designed for power flow towards load
- Inverter standards could be more “grid friendly”

5.4.1 Monitoring, Forecasting, and Control

Currently, much of the DG installed on the grid in California is not “visible” to the grid operators. This is due to a lack of monitoring and control capabilities combined with limited forecasting systems. As DG penetration grows, this may present a significant barrier to efficient use of the overall system in the future.

Currently, utilities do not monitor the real-time output of most customer-side DG plants. Only systems above 1 MW are required to install metering and telemetry that permit real-time monitoring. Most customer-side systems are behind the meter and offset load, and as a result, only the net load is visible to utilities. The lack of visibility in DG output has not been considered a problem in the past. In fact, historically, it was thought that the cost to monitor tens of thousands of smaller systems did not justify the benefits at low penetration levels. Furthermore, given the lack of standard communication protocols for the various DG equipment deployed, utilities find it challenging to collect and make use of the data.⁷⁸

As described in a recent report by Exeter Associates and General Electric, the lack of visibility into DG operation can be divided into two main concerns: (1) the impact of DG on load forecasting and (2) the potential for large amounts of DG to drop off the grid in response to system disturbances.⁷⁹ These concerns increase as DG penetration increases.

⁷⁸ While smart meters are being deployed through California, all IOUs indicated that smart meters do not currently improve their ability to monitor DG systems. Currently, there is generally no communication between smart meters and customer side PV systems. There are numerous challenges to this, as explained by the utilities in recent reports to the CPUC. See <http://www.cpuc.ca.gov/PUC/energy/Solar/UtilityProgramAdministratorsReportsUsingAMIForTrackingRooftopsolarGenerationJuly2012.htm>. SMUD and EPRI have just begun work on a pilot program to test a low-cost inverter-smart meter communication approach.

⁷⁹ Exeter Associates and General Electric, “PJM Renewable Integration Study. Task Report: Review of Industry Practice and Experience in the Integration of Wind and Solar Generation”, November 2012.

For wholesale DG systems, this type of monitoring is already typically present.⁸⁰ For smaller systems, SCE and SDG&E indicated that visibility into a system's status and production may be useful. SDG&E indicated that this visibility may possibly allow them to factor it into their transmission capacity margin calculations (see section 4.2.6). SCE indicated that monitoring of systems, particularly those larger than 250 kW, is necessary. At higher DG penetrations, the utilities may need to require monitoring at smaller DG sizes since smaller units may aggregate to a larger capacity and may have a more significant impact. IOUs recognize that having this capability would likely increase the complexity of their system operation significantly, but this may be necessary for the efficient and reliable operation of their system.

In addition to lack of monitoring, the utilities also do not typically have control capabilities to curtail the amount of energy DG systems produce. While significant impacts due to lack of monitoring and control may not appear for several years, it may be prudent to begin considering options ahead of time so as to be prepared. Germany, which has about 30 GW of solar PV connected to its system, has been dealing with integration issues for some time. It has recently instituted rule changes that will require retrofit of 315,000 older PV installations to allow varying levels of control. According to Exeter Associates:

Germany requires that all DG units equal to or greater than 100 kilowatts (kW), with the exception of solar PV, be remotely observable and dispatchable for the transmission system operator. Solar PV systems less than 100 kW are exempt from requirements to measure power output. However, solar PV units between 30 kW and 100 kW are required to be able to reduce output remotely in case of grid congestion. Further, solar less than 30 kW must be able to reduce output remotely in case of grid congestion or to reduce maximum power to 70% of installed capacity.⁸¹

In addition to lack of monitoring and control, reliable means of forecasting the near-term output from DG systems is only now emerging. Forecasting of DG, and PV in particular, may be necessary for integration of DG. Forecasting moving cloud cover and other weather changes will allow for improved control and function of the distribution system, balancing of generation in a control area, and more economical unit commitment. If forecasting capabilities are achieved, then control capabilities may become more valuable to curtail, increase or otherwise control distributed generation as necessary.

5.4.2 Modeling Tools for Integration of DG

There is a lack of easy-to-use modeling tools and data which allow users such as utilities to dynamically model renewable resources on the distribution system in conjunction with the transmission system. Some tools are being used to meet current needs, but as SDG&E indicated, they are not user-friendly and often require specialized personnel to run. Utilities would prefer to have this capability in house.

⁸⁰ Currently, telemetering requirements are imposed only on DG systems 1 MW or larger. Smaller units do not have this requirement since at lower penetrations the expectation was that the impacts would be minimal, the cost to collect the data would be relatively high, and processing of this additional data may not be necessary. This assumption should be revisited as penetration increases or the operational requirements for DG change. For example, California utilities have recently proposed telemetering requirements for certain wholesale DG systems smaller than 1 MW that will export power to be aggregated and scheduled into CAISO's market. As of this writing, the CPUC has not yet evaluated those proposals.

⁸¹ Exeter Associates and General Electric, "PJM Renewable Integration Study. Task Report: Review of Industry Practice and Experience in the Integration of Wind and Solar Generation", November 2012.

In addition to the lack of modeling software, certain inputs for this software are often limited – specifically, models for solar PV inverters that represent not only the static behavior, but also the dynamic behavior. SCE indicated that inverter manufacturers typically request non-disclosure agreements with utilities before providing detailed information on their machines. Because of this limitation, utilities generally create inverter models with several assumptions. The accuracy of the models may be limited because of the lack of data; and with the lack of data, utilities cannot be sure the modeling software they are using is appropriate. The limited accuracy could hinder further installation of DG, specifically solar PV.

There is not widespread use of high DG penetration models by distribution and transmission engineers, especially models that simultaneously simulate integrated transmission and distribution systems. The need for this type of model will become more pressing as the penetration of DG increases and reverse power flow from the distribution system to the transmission system grows more common.

5.4.3 Distribution System Design

The distribution system was designed to supply energy from the transmission system to loads. DG systems introduce energy sources on the distribution system. Because the distribution system was not designed for this functionality, there are challenges with integrating DG at high penetration levels, especially when they are not geographically spread out across the distribution system. This issue leads to some of the negative impacts of DG on the grid, such as reverse power flows. A potential benefit of DG systems is to reduce the number of system upgrades needed; however, this may not always be the case if DG deployment in a particular area increases the need for system upgrades.

5.4.4 Inverter Standards

IEEE 1547 is a voluntary standard for interconnecting distributed generation to the grid. Specifically, IEEE 1547 addresses topics such as performance, operation, testing, safety, and maintenance of interconnection. IEEE 1547 specifically calls for inverters to trip offline quickly in the event of a grid disturbance to avoid islanding of generation and other issues. In its current form, the standard does not allow features such as low-voltage ride-through (LVRT), which could be valuable in helping maintain system stability in the case of system disruptions. Revising this aspect of the standard, and possibly others, may allow inverters to be more “grid friendly” and better accommodate high DG penetration scenarios. Grid friendly inverters may allow better support or coordination with the grid regarding voltage and frequency.

As noted by PG&E, the national standards, such as IEEE-1547 and UL-1741 are not currently compatible with some of the desired inverter features, such as LVRT. While the IEEE-1547 and UL-1741 would need to be modified to pursue these advanced inverter features, the national standards may take some time to revise. Therefore, Rule 21 would need to be modified in parallel to revising the national standards.

5.5 MISCELLANEOUS

In addition to the technical and economic barriers and issues discussed in the previous sections, there are a number which are less tangible or quantifiable but are still significant for customer-side DG deployment. These issues and barriers include the following, and are discussed in the subsections below:

- Processing times and customer understanding

- Allocation of funds
- Multiple programs
- Availability of installers
- Marketing and consumer education
- Forecasting future installations
- Project siting

5.5.1 Processing Times and Customer Understanding

A significant barrier to DG deployment from the customer or developer's perspective is the administrative processing time required to participate in DG incentive programs, to apply for interconnection, and to obtain necessary inspections and safety checks. Customers and developers often cite this as a barrier because the time and effort to complete all these processes can diminish or even negate the expected benefits of the project. From the utility or program administrator's perspective, a closely related barrier is the fact that customers and developers often do not have sufficient background or experience to complete these processes successfully, and their lack of understanding causes administrators to spend time orienting them to the processes. This takes away staff resources from reviewing and approving applications for incentives, interconnection, etc. Another related barrier is that DG administrators may be short-staffed relative to the volume of applications received, for a variety of reasons.

5.5.2 Allocation of Funds

Existing DG incentive programs generally have targets or allocations for how much funding should be directed to certain types of DG installations. For instance, many of the programs attempt to divide funds evenly between residential and non-residential (commercial, industrial, government, non-profit, etc.), and many also have "carve-outs" for low-income projects. In the case of the CSI program, MASH and SASH were created as entirely separate programs to ensure that a designated amount of funding reached low-income projects.

Issues related to allocation of program funds are often perceived as a problem by participants, but the nature of the problem depends on the participant's perspective. Low-income homeowners or renters may see the limit on funding for low-income projects as a problem if there is substantial competition for these funds. Utilities may see the division of funds between residential and non-residential projects as an issue preventing efficient use of funds, because some feel that larger non-residential projects are a more cost-effective use of public money than smaller residential projects, due to the lower per-kW costs for larger systems. Conversely, residential customers might view the allocations for large commercial projects as hindering their own participation since the remaining funds for small residential projects are then more limited.

Total funding for non-renewable DG systems is generally less than that for renewable DG, and they often receive a lower incentive per kW. Since it is less likely to be installed, this may be considered an issue specifically for non-renewable DG.

5.5.3 Multiple Programs

Section 3.0 of this report describes a number of different programs supporting DG in California. The proliferation of these programs may be an issue to some degree in itself. From a customer or project developer's perspective, there may be confusion about the program(s) for which their project is eligible. This can lead to project delays in some cases, and also to frustration on the

customer's or developer's part. From a utility or program administrator's perspective, there may be difficulty due to limited financial or staff resources, such that it is not efficient to administer a number of different programs. However, DG program managers did indicate that this was not a major concern for utilities in deploying DG, and that the array of different DG programs was appropriate because each is targeted at a different project type or customer segment. Their main concern was that they spend a significant amount of staff time educating customers, installers, and developers who are unfamiliar with the multitude of programs.

5.5.4 Availability of Installers

In order to deploy customer-side DG, skilled and experienced installers must be available to support voluntary DG installations. The rate of DG deployment depends in part on the availability of installers, and a lack of installers in the past constituted a barrier to greater deployment. In general, utility representatives agreed that a lack of DG installers may have been a problem previously, but that it is not a widespread barrier now because the volume of installations and installers has risen dramatically and so has the number and coverage of existing installers. In the opinion of utility representatives, competent installers are now available in most parts of California.

5.5.5 Marketing and Consumer Education

Because DG installations are voluntary, customers must first be aware of DG as an option for their electric needs, and also see it as a potentially beneficial option—in terms of economic cost, environmental impact, energy independence, local job creation, or some combination of these. DG incentive program managers confirmed that this issue has been and continues to be a barrier for greater DG deployment in California, though it is not considered significant enough today to be listed as a key barrier. The general public is much more aware of DG technologies and their benefits now than was the case a few years ago, due largely to the funding and efforts of the state's DG programs as well as the efforts of installers themselves, who perform a substantial amount of marketing and consumer education as part of their sales process. However, more investment in marketing and education of consumers would likely reduce this particular barrier further.

There are also opportunities for better targeting of such marketing and education efforts, but many of these would require information sharing between entities. For example, CCSE administers the CSI and SGIP programs in SDG&E's service territory, and also leads marketing for these DG programs to SDG&E customers. However, CCSE does not have access to specific customer information which could help it to target its marketing toward those customers most likely to adopt DG, e.g. higher income customers, customers with relatively high usage, customers on distribution circuits with significant excess capacity, etc.

5.5.6 Forecasting Future DG Installations

The ability or inability to forecast future DG installations is an issue for utilities and program administrators. Program administrators need such forecasts of installations to allocate financial and staff resources and plan for future changes in budget or staffing levels. When the forecasts are inaccurate it can lead to insufficient resources and therefore backlogs in DG application processing. Utility distribution planning processes should have forecasts of future DG installations and output to design their systems. As DG installations increase, inaccurate forecasts could impact the growth of the distribution system such that appropriate infrastructure is not available to accommodate growth of DG installations in the most cost-effective manner. Program administrators indicated that short-term DG installation forecasts have become relatively reliable based on analysis of recent installation trends, but that long-term forecasts are much less reliable because of the variety of policy and market factors affecting DG deployment and the rapid pace at which they change.

Overall, they claimed that long-term forecasting is not yet a substantial issue. However, utility distribution engineers did see this as a potentially significant issue for future DG expansion, although it has not manifested to a large extent yet.

5.5.7 Project Siting

There are several aspects of siting a DG project that could constitute a barrier to further deployment of DG. It has been estimated that up to 75 percent of electric customers do not have the ability to install solar PV on their own property.⁸² There are a variety of reasons for this, including: 1) residential and commercial renters often do not have the necessary authority to install permanent equipment like a PV system, 2) many homes are located in areas with inadequate resources (e.g., too much shade) or infrastructure (roofs with a non-optimal orientation), 3) non-taxable entities cannot take advantage of the ITC or other tax benefits available for PV, and 4) a variety of customers do not have the time or financial capacity to install PV. All of these barriers apply in principle to non-solar types of DG as well. PG&E indicated that DG technologies other than solar, such as wind, are actually much more complex and less common, which can be a barrier for customers to site and successfully install due to the relative lack of technical expertise, potential community reaction, and questions from permitting authorities.

A potential solution to this barrier is the use of virtual net metering, which allows multiple customers to obtain bill credit for electricity produced at another site and count it toward their own electricity consumption. In the U.S., virtual net metering arrangements are often used by “community solar” projects (when the power is generated by solar PV), which refers to a range of program and project types that allow groups of customers to receive benefits from a single solar development. The same structure has been used in other parts of the U.S. and Europe for small-scale wind systems. Community solar projects can be built and financed by independent developers, in which case the arrangement can be similar to a third-party solar lease or power purchase agreement, or by utilities, which can offer customers the ability to directly purchase a portion of the project’s output or to participate in a “solar rate”. These projects have the potential to take advantage of better sites (in terms of resource, ease of interconnection, public visibility, etc.), to reduce costs through economies of scale, to eliminate the customer’s responsibility for financing costs or operations and maintenance, to facilitate participation for those customers who could not otherwise build solar PV, and to enable customers to continue benefiting from the project even if they move.⁸³

However, it should be noted that many of the same cost allocation concerns that apply to regular NEM installations also apply to virtual NEM arrangements—customers participating in a virtual NEM arrangement may receive a subsidy from other ratepayers.

5.6 KEY ISSUES AND BARRIERS

California has made significant progress addressing issues and barriers related to DG. Many of the issues and barriers listed in this section have been at least partially addressed, and the industry and regulators are working on many others. The issues and barriers described in this section may limit or otherwise affect the deployment of DG, and several of them impact the ability to receive the touted benefits of DG. The key issues and barriers identified in this report are listed below.

⁸² The Vote Solar Initiative, “Community Shared Solar: Bringing Solar to the Masses,” presentation by Hannah Masterjohn, July 2012.

⁸³ Solar Electric Power Association, “Utility Community Solar Programs,” presentation by Bianca Barth, July 2012.

Table 5-3 Key Remaining Issues and Barriers for Customer-side DG**Financing and Economics**

- Equipment and soft costs of DG are high compared to grid electricity.
- Availability of government and utility financial incentives is becoming more limited because funds for incentive programs are declining.

Policy and Regulatory

- Public resistance to DG could develop if non-DG customers are excessively burdened with costs to subsidize NEM DG customers.
- There is a lack of incentives to locate DG in areas with the greatest benefit to the grid; need to adopt a more targeted approach.

Integration

- Lack of monitoring, forecasting and control capabilities limits the utilities' ability to manage DG integration into the distribution system, and ability to rely on DG capacity.
- Lack of capabilities integrating DG (especially solar PV) with distribution and transmission models. This affects the utilities' abilities to accurately simulate and plan for DG.
- Distribution system design is not intended for injection of generation leading to voltage issues, reverse power flow, etc. This issue will become more widespread as DG penetration increases.
- Inverter standards may need to be changed to allow better support of the grid.

Miscellaneous

- Processing times and administrative delays for incentive applications and interconnection applications reduce the speed at which DG can be deployed.
- Lack of suitable project sites prevents the majority of utility customers from installing DG on their own property.

6.0 Emerging Technologies

A large amount of research and development is being done on emerging technologies which may alleviate some of the negative impacts and barriers to greater DG deployment. The major technologies being developed include:

- Smart inverters
- Energy storage
- Advanced grid management / smart grid technologies
- Microgrid technologies

This section discusses each of these technologies and their potential benefits.

The deployment timeframe of these technologies varies. There are number of demonstration projects completed or underway. Greater appreciation of the need for these technologies will follow an increased deployment of DG systems and identification of the technical problems that these new technologies may be able to resolve. It is not known whether the “tipping point” at which these technologies will become beneficial, or even essential, will occur within the next 1 to 3 years or the next 5 to 10 years. However, given the rapid pace of DG deployment in California, it is reasonable to proactively demonstrate and deploy the emerging technologies with the greatest potential benefits.

Although the state hosts a number of DG technologies, the vast majority of DG in California is solar PV. Solar PV and wind DG both have issues associated with their variability, but the amount of wind DG is very small compared to solar PV. Other DG technologies such as fuel cells and internal combustion engines do not pose all of the same challenges as variable generation like PV. They have the ability to be dispatchable, although there is currently no process to enable dispatch by the utility.⁸⁴ Thus, because of its deployment share and the complexity of issues associated with variable generation, this section will focus on emerging technologies related to solar PV.

6.1 SMART INVERTERS

The inverter is the “gatekeeper” of solar power, whether fed directly to an end user, to an energy storage system, or through an interconnection onto the grid. For grid interconnections, next generation inverters, or smart inverters, are machines that have special functions designed to remedy grid faults and protect the quality of grid power by minimizing their impact to the grid. They are used for utility-scale solar PV systems in North America and both utility-scale and large distributed solar PV systems in Germany.⁸⁵

The potential for smart inverters is significant. Studies have shown that they may be able to mitigate voltage issues and increase the grid’s capability to accommodate PV significantly.⁸⁶ Smart inverters might provide many advances including:

⁸⁴ Despite the fact these technologies are more firm than variable renewables, these types of DG systems are typically baseload rather than having dispatch agreements with the utility. This makes it difficult for the utility to curtail these units even during system emergencies.

⁸⁵ Notholt, “Germany’s New Code for Generation Plants connected to Medium-Voltage Networks and its Repercussion on Inverter Control”, European Association for the Development of Renewable Energies, Environment and Power Quality, April 2009.

⁸⁶ Braun, et al., “Is the distribution grid ready to accept large-scale photovoltaic deployment? State of the art, progress, and future prospects”, Progress in Photovoltaics: Research and Applications, 2010.

- Remote monitoring
- Voltage regulation
- VAr control
- Low voltage and low frequency ride-through
- Ramp rate control
- Curtailment ability

These smart inverter features would be used in combination with distributed communication infrastructures to manage solar power injected into distribution systems in a manner that is coordinated among solar power and conventional generation sources. The result could be a strengthening of distribution systems through the use of reactive power to regulate voltage along distribution feeders.

Currently, smart inverters are not code compliant for use with distributed PV systems in the United States. National standards, IEEE-1547 and UL-1741 do not comport with many of the smart inverter features mentioned. However, these standards are voluntary by utilities and could be decoupled from Rule 21 to allow use of smart inverters in California. The State could wait for national standards to be revised, but the process may take years. According to code, DG inverters must disconnect from the grid for five minutes when they sense a problem with the quality of grid power and not reconnect until the problem is resolved. The intention of this requirement is for PV systems to be taken offline so the grid can recover on its own. Code also requires that inverters disconnect from the grid during power outages to prevent solar power from harming linemen.

In high-penetration PV scenarios, some researchers believe the current U.S. code requirements could cause cascade disconnects of large swaths of PV systems during grid faults and thus exacerbate grid instability.⁸⁷ Smart inverters have the ability to prevent this by staying connected and “riding through” momentary grid faults (discussed further in Section 4.1.5). They can also provide voltage support to the grid during faults, thus strengthening power quality and the reliability of the grid. The power industry calls this type of grid support “ancillary services”. Some smart inverters can provide ancillary services at night in addition to during the day.

Ramping down solar power smoothly to reduce solar power variability is another feature associated with smart inverters. However, smart inverters alone are not capable of ramping down individual solar power systems. Energy storage and/or accurate solar resource forecasting combined with automated power curtailment are also needed.

It is important to note that smart inverter features do not come without additional cost. This additional cost could be quite large depending on communications requirements (such as running a new fiber optic line) or if energy storage is included. Therefore, smart inverters are not a solution to all DG issues, and their costs must be weighed against the cost of other means to support higher penetration PV such as replacing distribution line conductors, installing capacitor banks in substations, etc.

Given their reactive and remedial capabilities, smart inverters have great potential; however, there are significant challenges to using smart inverters for DG. In addition to the aforementioned standards and cost challenges is the development of a distributed communication infrastructure to signal the inverters to disconnect when distribution lines are severed or when grid operators issue

⁸⁷ “Solar Energy Grid Integration Systems (SEGIS) Program Concept Paper”, US DOE EERE/Sandia, October, 2007.

a command. Also, a protocol may need to be developed to coordinate the operation of all the smart inverters so that they will work together properly. To address the communications challenge, several solutions are being explored:

- A solution has been demonstrated at Lakeland Electric in Florida by Satcon, an inverter manufacturer, in collaboration with Cooper Power Systems and the Florida Solar Energy Center. The demonstration was part of the DOE's Solar Energy Grid Integration Systems technology acceleration program, using a technology called power line communications.⁸⁸
- Another possibility, mentioned during Black & Veatch's interviews with the utilities, is for utilities to control inverters through smart meters via ZigBee or another wireless communication protocol; however, until the PV industry has an approved ZigBee inverter protocol for Smart Inverters, this option is not technically feasible.
- A third option is to institute autonomous or pre-set functionalities for smart inverters to perform in response to certain voltage conditions, thus requiring no control by the utility. As noted in this report, this option is being examined in Phase 2 of the CPUC's interconnection proceeding.

Finally, another challenge for smart inverters is that utilities are not required to pay all customers for the ancillary services they could provide for grid support, especially if the inverter is behind the customer's meter.

As noted above, the introduction of autonomous smart inverter functionalities on certain DG systems is included in Phase 2 of the CPUC's interconnection proceeding.

6.2 ENERGY STORAGE

Energy storage devices such as batteries, flywheels, compressed air, ultra-capacitors, and pumped storage hydro, can also aid in accommodating the integration of variable DG resources into the grid. When PV generation drops, storage devices can be brought online to mitigate output swings, to provide smoothing or firming, and to serve load until other reserves can be brought online.⁸⁹ Storage technologies have different characteristics (such as storage capacity, discharge duration and cost) that make them more or less suited for particular applications. In general, the energy storage technologies are grouped into power and energy applications. Below are some potential energy storage solutions grouped by discharge duration, or energy, capabilities:

- Short Duration (batteries, flywheel, ultra-capacitor)
- Medium Duration (batteries)
- Long Duration (pumped storage, compressed air storage)

⁸⁸ "Solar Energy Grid Integration Systems: Final Report of the Florida Solar Energy Center Team", SANDIA REPORT SAND2012-1395, March 2012.

⁸⁹ It is also noteworthy that curtailing inverters in advance of steep declines in solar resource using accurate weather forecasting may reduce energy storage capacity required.

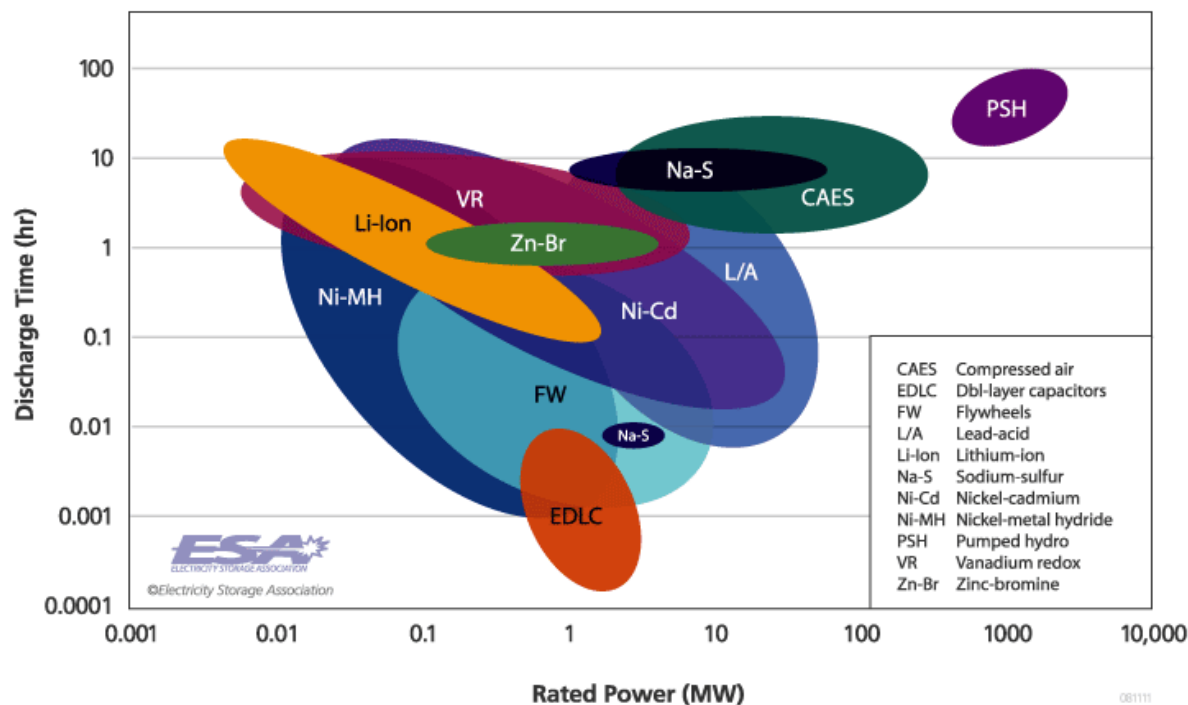

Figure 6-1 Energy Storage Discharge Time and Rated Power Graph⁹⁰

Energy storage technologies can span a wide range of power capabilities as well. Figure 6-1 above is a graphical representation of power and energy capabilities of energy storage technologies compiled by the Electricity Storage Association (ESA).

Of these options, batteries are most often deployed with PV. Lead acid batteries have been used with off-grid PV systems for decades, but are rare among grid-connected systems. However, batteries are now being demonstrated to reduce the variability of solar power, provide ramp rate control, provide ancillary services support to the grid, improve power quality, and for load shifting—i.e. storing electricity generated during off-peak times and using it during peak times.⁹¹ Batteries are also used in combination with other technologies to provide continuous support for facilities during grid outages in systems sometimes referred to as microgrids, described later in this section.

The principal two impediments to batteries and other energy storage technologies are (1) their relatively high costs (exacerbated by a relative lack of cost data publicly available) and (2) inability to fit into existing regulatory and operational framework that makes taking advantage of multiple benefits from a single location difficult. Regulators, including FERC and the CPUC, have begun to recognize that energy storage technologies require special consideration and to modify the appropriate product and compensation rules. In fact, due to Assembly Bill 2514, the CPUC is currently considering whether to implement specific procurement targets for energy storage in

⁹⁰ Electricity Storage Association

⁹¹ “Solar Energy Grid Integration Systems –Energy Storage (SEGIS-ES) Program Concept Paper”, DOE EERE and Sandia, May 2008.

California by utility, to accelerate deployment and decrease costs through economies of scale.⁹² CAISO has also begun considering a process for energy storage to participate in the CAISO wholesale market, as discussed in Section 5.3.3. In addition, metering and monitoring protocols for energy storage are still being refined.

Researchers are also working to bring down the cost of batteries while improving their performance through technological innovations. Recent advances in battery technologies have been driven by mobile electronics and electric vehicles. Lead acid batteries are the traditional complement to solar PV systems, but lithium ion batteries with unique cathode, anode and proprietary electrochemical variants are quickly becoming popular options. Today's research is largely focused on increasing the energy density of batteries while driving down the battery cost and improving battery safety. One battery option under development that shows potential for improving the energy density of batteries is the zinc-air battery. Zinc-air batteries may be less expensive than lithium ion, and less toxic and lighter than lead-acid batteries. Additionally, lithium-sulfur and lithium-air batteries could further advance the battery energy density by employing nanostructures and novel electrode combinations.⁹³

Energy storage devices do not necessarily need to be co-located with PV. They could be widely distributed across the grid to meet multiple needs in different applications at various scales—from large centralized storage devices at substations, to community energy storage devices on distribution feeders, to small devices at individual homes (see Figure 6-2). For example, larger, centralized energy storage systems deployed for commercial purposes are being tested to shave peak load and could be used to firm solar power.^{94,95} Central energy storage systems include both metal ion varieties and flow batteries, devices that use electrolytic fluids to store energy. Batteries in electric vehicles are also being considered as an energy storage component. Though the appropriate infrastructure would need to be developed, they could be used to firm solar power and reduce peak loads.⁹⁶ Understanding the optimum mix of technologies and their placement is a challenge for the future cost-effective deployment of energy storage. In addition, more research is needed on the ramping responsiveness of various types of storage to determine whether it could be widely deployed across the grid to meet multiple needs in different applications at various scales—from large centralized storage devices at substations, to community energy storage devices on distribution feeders, to small devices at individual homes.

⁹² E. Wesoff, "California Energy Storage Bill AB 2514 Signed Into Law by Governor," Greentech Media, Sept. 2010. <http://www.greentechmedia.com/articles/read/vc-cmeas-gunderson-on-utility-scale-storage/>. The CPUC's storage proceeding is Order Instituting Rulemaking Pursuant to Assembly Bill 2514 to Consider the Adoption of Procurement Targets for Viable and Cost-Effective Energy Storage Systems, R.10-12-007, Issued December 21, 2010.

⁹³ Yang, Y. McDowell, M. Jackson, A. Cha, J. Sae Hong, S. *Nano Lett.* 2010, 10. 1486-1491.

⁹⁴ "Public Interest Energy Research (PIER) Program Final Project Report, Demonstration of ZBB Energy Storage Systems", July 2012.

⁹⁵ "Energy Storage Shaping the Future of California's Electric Power System", California Energy Storage Alliance (CESA) and Strategen, Intersolar, June 2011.

⁹⁶ "Vehicle-To-Grid Technology Gains Some Traction", *New York Times*, July 22, 2009.

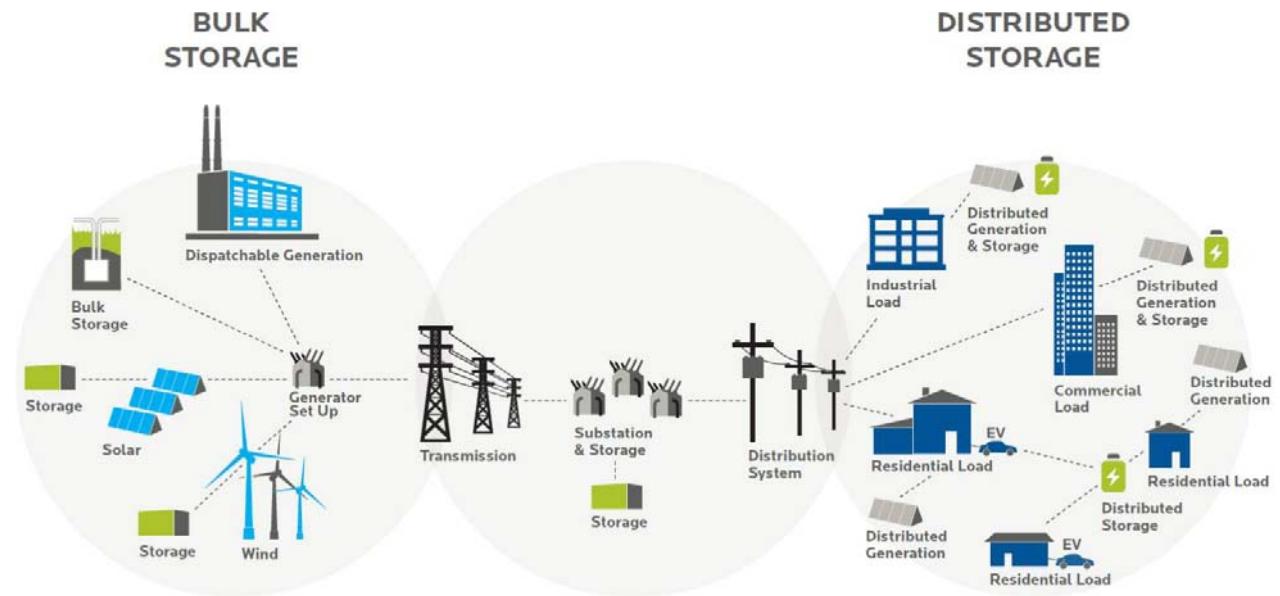

Figure 6-2 Potential Applications of Energy Storage (Black & Veatch)

6.3 ADVANCED GRID MANAGEMENT / SMART GRID TECHNOLOGIES

As mentioned previously, the variable generation of solar PV systems may impact normal grid operations. Grid operators are constantly working to balance supply and demand on the grid. They must maintain power quality by regulating voltage, current, and frequency. Smart grid technologies would allow increased awareness and control of the distribution system and may enable solutions to many DG integration issues. Smart inverters for DG on the customer side have the potential to complement smart grid technologies on the utility side of the distribution system, and smart grid technologies can also support the use of energy storage.

A number of efforts in the areas of smart grid infrastructure are underway to prepare for high penetration DG PV (Figure 6-3). This section describes some potential smart grid solutions.

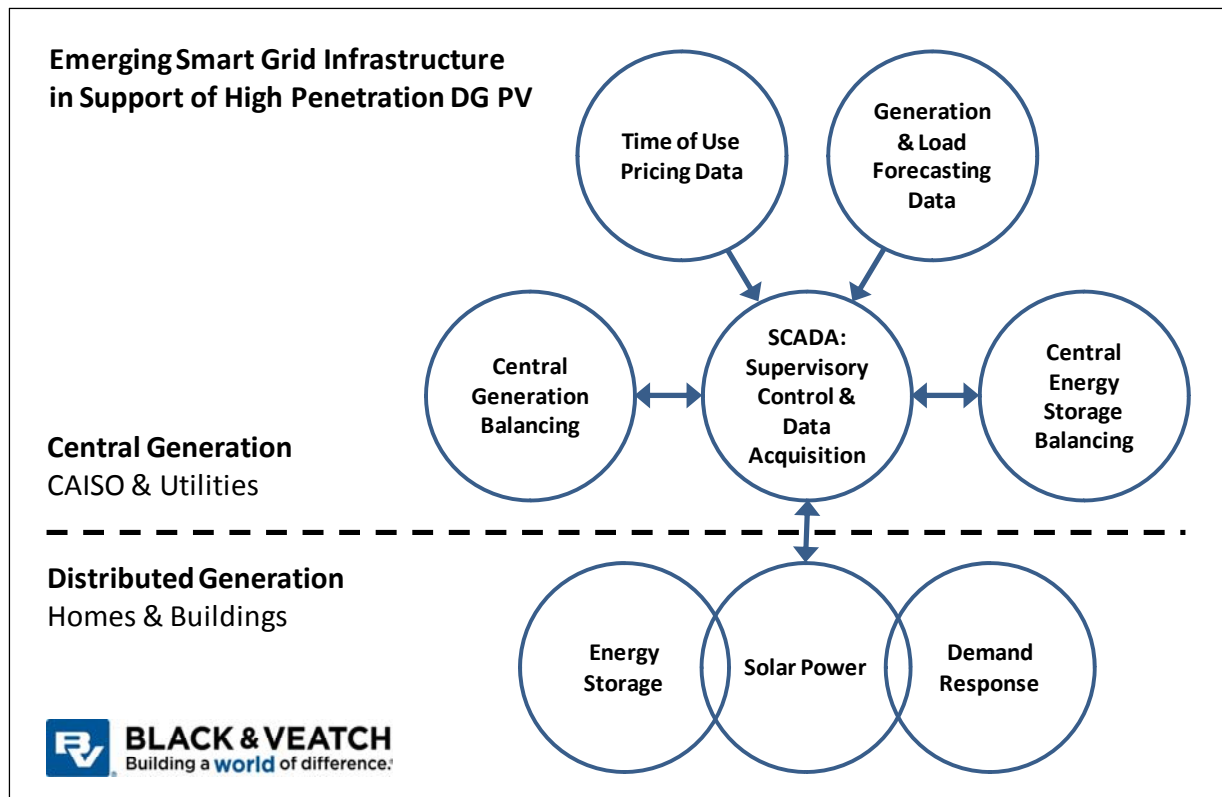

Figure 6-3 Emerging Smart Grid Infrastructure in Support of High Penetration DG PV

- **Enhanced Voltage Measurement and Automated Control** –Voltage regulation is a core function of utility operations, but DG has the potential to make voltage regulation significantly more difficult. However, widespread deployment of advanced metering infrastructure (AMI), or “smart meters,” has created a new technology enabler that can improve voltage control effectiveness and help mitigate some of the issues related to DG. Smart grid and AMI systems have laid the foundation for improved voltage management by providing reliable, two-way communications between numerous field devices. Intelligent electronic devices (IEDs) in combination with substation/feeder control or new centralized distribution management systems (DMS) can measure voltage from every grid endpoint and provide improved voltage controls. Systems such as Advanced Volt VAR Control (AVVC) can allow enhanced control of voltage and VAR flow. AVVC allows a more efficient use of field capacitor banks and other equipment to optimize power flow.
- **Load Control** – Direct load control allows utilities to turn on and off certain loads (i.e. facilities, equipment, appliances, etc.) during certain periods when electricity demand is high, or when intermittent distributed generation ramps up or down suddenly. This can enable utilities to manage and optimize an increasingly dynamic electric power grid on which power is injected at distributed locations throughout the system.
- **Re-Sectionalizing** – Grid re-sectionalizing involves the automatic rerouting of power from one part of the grid to another. As the distribution system becomes more dynamic, and variable DG sources are added in large quantities, it will be important for utilities to be able to manage power flow and voltage among different sections of the grid. Widespread use of

automated switching systems will be an important component of this solution. The figure below illustrates an example of re-sectionalizing.

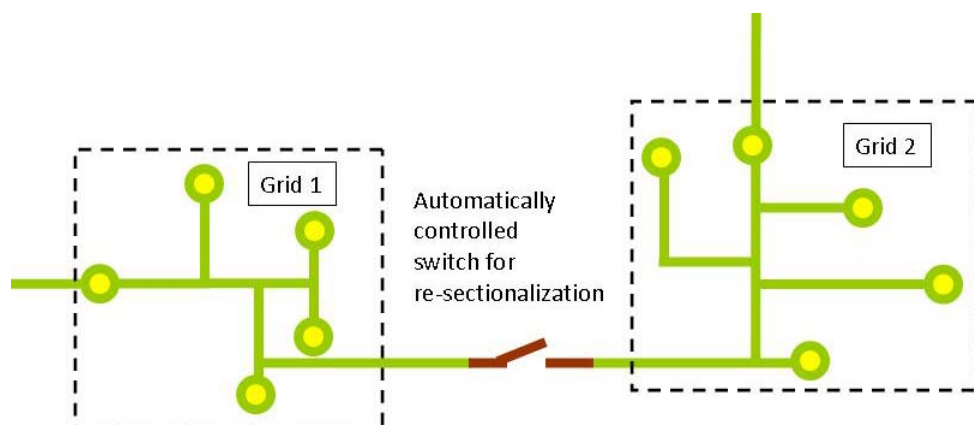

Figure 6-4 Re-sectionalization Example

- Distribution Management System (DMS)** – DMS is an integrated decision support system whereby all operational aspects of the utility’s distribution system are made visible and operable from a central source. Advanced algorithms are used to optimize the system in real-time based on values provided by AMI and supervisory control and data acquisition (SCADA) systems. A DMS can be enhanced with centralized volt/VAR optimization (VVO) based on an on-line power system model.⁹⁷ Implementing a DMS with VVO is a major initiative that could take multiple years to complete; however, it has many broad benefits. For integration of DG, a DMS can help a utility maximize its multiple distributed energy resources taking into account load forecasts, weather forecasts, DG output forecasts, electric vehicles, and storage. This includes handling resource dispatching, initiating demand response programs, verifying and validating active demand response programs, mitigating voltage issues, and managing a networked power system grid with bi-directional flows. If communication protocols are harmonized, a DMS could also provide direct communication with DG smart inverters that would further enhance grid operations.

Smart grid technology, and the advanced grid management solutions that it enables, is an emerging field. Additional smart grid technologies not covered here may help address other challenges in the future.

6.4 MICROGRIDS

One subset of the emerging smart grid infrastructure is “microgrids,” which could be particularly important for grid integration of DG in the future. A microgrid is a small power system that incorporates self-generation, distribution, sensors, energy storage, and energy management software with a seamless and synchronized connection to a utility power system.⁹⁸ A microgrid can

⁹⁷ VVO is a method of optimizing distribution power delivery, which utilizes distribution automation, SCADA, and AMI to reduce energy consumption and peak energy capacity demand by improving system power factor. VVO is based on sophisticated algorithms and logic from the on-line power flow application, which is another application within the DMS suite.

⁹⁸ <http://www.smartgridlibrary.com/>

operate in parallel with the utility or independently as an island from that system. Its purpose is to increase reliability for customers within the microgrid by maintaining power even when the utility grid is experiencing an outage, and also to allow localized control of energy infrastructure. Theoretically, microgrids can also support the larger utility grid by decreasing local load and safely exporting power at times when the utility grid is stressed. In addition, microgrids have the potential to provide a number of services which would enable greater DG penetration:

- Seamless bidirectional energy flow
- Voltage, frequency and VAR control
- Elimination of momentary outages associated with typical standby/backup power systems
- Price driven load management, i.e. demand response based on dynamic price signals
- Self-healing networks through integration of feeder automation
- More robust communication and control of the distribution system

A number of utilities—including SDG&E and SMUD—are investigating the costs and benefits of microgrids through demonstration projects, usually funded by grants from the U.S. DOE and the CEC. SDG&E has significant microgrid projects operating within its service territory which incorporate DG as one of the core components:

- 1) **University of California San Diego (UCSD) Microgrid:** The UCSD campus has invested significant resources in tying together distributed PV resources, a biogas fuel cell, and a natural gas central cogeneration plant with responsive loads in campus buildings through an increasingly sophisticated central control system. It is claimed that the flexibility of this 42 MW microgrid allows the campus to save significant amounts of money on its utility bills annually, and provides up to 85 percent of campus electricity. Also, UCSD has been able to reduce its local loads and export power to the SDG&E grid during emergencies such as the blackout of September 2011 and the wildfires of 2009.⁹⁹ The campus was able to switch from importing 3 MW of power to exporting 2 MW of power within 30 minutes during the 2009 incident and thereby provide critical support to the larger grid.¹⁰⁰ The UCSD microgrid is an evolving and ongoing project, funded by the university, and will continue for the foreseeable future.¹⁰¹
- 2) **Borrego Springs Microgrid Project:** This project in the San Diego area is designed as a pilot-scale proof of concept of how information-based technologies and distributed energy resources may increase utility asset utilization and reliability, including contributions from a number of organizations and vendors (IBM, Horizon Energy Group, Motorola, Pacific Northwest National Labs, Oracle, Advanced Energy Storage, University of San Diego, Lockheed Martin, GridPoint, and Xanthus). Its goals are to: 1) reduce feeder peak load by more than 15 percent through DG, energy storage and load management; 2) demonstrate VAR management; and 3) develop and test a variety of distribution management systems and capabilities—e.g., advanced metering infrastructure, outage management systems, feeder automation technologies, price driven load management, and intentional islanding. It incorporates a wide variety of customer-side technologies, including rooftop solar PV, battery storage, grid-friendly appliances, demand response through remote-controlled thermostats, and plug-in hybrid electric vehicles. The small town of Borrego Springs, east of

⁹⁹ <http://blog.rmi.org/the-ucsd-microgrid-showing-the-future-of-electricity-today>

¹⁰⁰ <http://www.rmi.org/nations-largest-microgrid-online-esj-article>

¹⁰¹ <http://sustainability.ucsd.edu/initiatives/energy-production.html>

San Diego, already had a large amount of solar PV installed even before this microgrid project began. The project includes three different types of battery energy storage (a large battery at the substation, three medium-sized batteries on a distribution feeder, and six small batteries at individual homes); a microgrid yard at the substation with diesel generators, transformers, a SCADA switch, and a control van; home area networks capable of responding to price signals and reliability events, with smart appliances throughout the home; and a significant amount of distributed PV throughout the community. The microgrid will be owned by SDG&E. This project is billed as the first large-scale utility-owned microgrid in the U.S., with the goal of proving an alternative service delivery model, islanding real customers, and establishing a template for other utilities to follow. Design and planning began in 2010 and the project is expected to be completed in 2013.¹⁰²

Most microgrid projects today involve some degree of retrofit to existing distribution systems, and also incorporate a wide range of new technologies and software for research purposes. Thus, there is limited data on the costs of new commercial microgrids implemented in real settings with only the technology needed for the particular location in question. However, gathering further data on commercial microgrid costs would be useful from the perspective of understanding the cost of integrating DG, since many of the features of microgrids may be necessary in future distribution systems with high penetrations of DG.

¹⁰² SDG&E, "SDG&E Borrego Springs Microgrid Demonstration Project," presentation by Thomas Bialek, June 2012.

7.0 Recommendations for Future Study

Distributed generation deployment on the California distribution system has been increasing over the past several years. With this increase, there are several unknowns. While this report describes many of the impacts of DG, nearly all of the information is qualitative and based on limited observations. There is much to be gained from a more detailed and quantitative investigation of the current and future impacts of DG on the electric grid of the IOUs in California. Such an investigation should rely on “real-world” field data to the extent possible. Quantification of DG impacts is vitally important to the DG industry, utilities and policymakers. It will inform decisions that seek to further DG goals while minimizing the negative impacts of DG and maximizing its benefits.

Black & Veatch has detailed a scope for such a study, included in Appendix C. In summary, this type of investigation would address the following questions:

- How is DG affecting the distribution and transmission system currently, and how will this change in the future?
- How much more DG could be deployed on the system if siting were optimized for minimal impacts and enhanced benefits?
- What additional tools are needed to identify optimal location, type, and timing of DG?
- How can an enhanced understanding of the costs of different impacts, benefits and solutions help inform effective policy to enable the deployment of more DG?
- How could the deployment of more DG be beneficial? If deployed ineffectively, how could it be deleterious?

Answering these questions can help create a clear roadmap of the growth potential of DG and enable California to anticipate potential challenges to DG deployment. A comprehensive study can help answer the questions by summarizing the analysis that has been done to date, analyzing the available data for existing systems, and forecasting impacts of future growth.

Such an analysis should study the five primary sections listed and described below:

1. **Existing Conditions** – A literature review and quantitative assessment of the following:
 - a. Status of DG on the distribution system in California
 - b. Trends in DG deployment
 - c. Status of DG in other states and countries
2. **Impacts and Costs of DG** – Compile data on DG in California and extract meaningful trends to quantify current impacts and costs of DG in California.
3. **Potential Benefits of DG** – Quantify benefits (or, in some cases, costs) of DG during operation such as line losses, avoided energy, and reduced peak demand.
4. **Solutions** – Identify and discuss potential solutions or strategies that may mitigate impacts and enhance benefits of DG.
5. **Scenario Analyses** – Perform modeling that identifies different DG penetration scenarios and the associated impacts. This may include modeling impacts at different DG penetration levels, different feeder types, the effect of solutions identified in section 4, and various DG technologies.

The analysis should focus on the status, impacts, costs, and benefits of DG on the distribution system, rather than the transmission system, and it shall be a technical and quantitative analysis.

In addition to the above described analysis, the following areas should also be studied:

- Reporting issues: review NEM installation data and compare against incentive program databases
- Impact of DG (PV and non-PV) penetration if incentives and subsidies are not sustained and what other mechanisms can help sustain the market
- Development of user-friendly models for transmission, distribution, substation and feeder level impacts with increased DG penetration. This should include transient and dynamic modeling of DG systems.
- Develop a consistent approach to distribution modeling across utilities

Appendix A. Installed Capacity Data

To ensure transparency, data sources for installed DG capacity in each DG programs and the methods used to filter each dataset are listed in Table A-1 below. In all cases, the installed capacity reported below for each program is current as of the end of 2011.

Table A-1 Data Sources and Data Filtering

PROGRAM	DATA SOURCE	STATUS(ES) INCLUDED	DATE FILTER USED	SYSTEM SIZE FIELD NAME
CSI General Market	CSI Working Data Set (6-27-2012)	Online Incentive Claim Form Submitted, Incentive Claim Request Review, Suspended Incentive Claim Request Review, Pending Payment, Completed, PBI - In Payment	First Incentive Claim Request Review Date prior to 2012	CEC PTC Rating
MASH	MASH Semi-Annual Progress Report, Feb. 2012	N/A	N/A	CEC-AC MW
SASH	2011 Q4 SASH Program Status Report, Jan. 2012	N/A	N/A	Total kW (CEC-AC)
SGIP	CPUC Database	Incentive Claim Review, Pending Payment, Completed	Incentive Claim Review Date prior to 2012	Capacity [kW]
ERP	CEC Database	Paid	Date Paid prior to 2012	System Size (Watts)
NSHP	CEC Database	Payment Approval	Payment Approval Date prior to 2012	System Capacity
SB 1 POU	CEC SB1 POU Life of Program and Yearly Statistics for 2011	N/A	N/A	Total kW Installed
NEM	CPUC Interconnection Data Request, Q1 2012	N/A	Interconnection Year prior to 2012	"Total Inverter Nameplate (kW)" - PG&E; "NEM Cap qualified (kW)" - SCE; "Nameplate Rating (kW)" - SDG&E
FIT - AB 1969	IOU AB 1969 Contract Spreadsheets	Online/Operational	Actual COD/Operational Date/New Online Date prior to 2012	Capacity (kW)/MW
FIT - SB 32	N/A	N/A	N/A	N/A
SPVP	CPUC RPS Contracts Database	Operational/Online	Online Date prior to 2012	Min MW
RAM	N/A	N/A	N/A	N/A

Appendix B. Peak Demand Impact Analysis Methodology

In determining the peak demand impact, Black & Veatch used the total installed DG capacity as of the date on which the peak demand occurred, which was September 7th, 2011. The total installed DG capacity on the CAISO grid as of September 7th, 2011 by technology is presented in Table B-1.

Table B-1 Total Installed DG Capacity on CAISO Grid as of 9/7/2011

TECHNOLOGY	MW INSTALLED
Solar PV	892
Wind	12
RF	
– FC	23
– MT	4
– ICE	12
Non-RF	
– FC	18
– MT	20
– GT	31
– ICE	142
AES	2
Total	1,156

Solar PV Peak Demand Impact

Black & Veatch obtained actual 15-minute production data for solar PV systems installed under the CSI program and SGIP. Metered systems for which this data was available constitute only a sample of the total PV installations on the CAISO grid, so it was necessary to calculate peak hour capacity factors based on this production data and apply these factors to the rest of the PV systems which were not metered. To capture the diversity in capacity factors among the metered systems, the systems were categorized according to various “strata.” These strata are shown in Table B-2.

Table B-2 Strata Used to Categorize Solar PV Installations

PROGRAM	PROGRAM ADMINISTRATOR	INCENTIVE TYPE/SYSTEM SIZE	LOCALE	INSTALLATION YEAR GROUP
<ul style="list-style-type: none"> CSI (incl. MASH & SASH) SGIP ERP NSHP 	<ul style="list-style-type: none"> PG&E SCE SDG&E/CCSE SCG 	<ul style="list-style-type: none"> EPBB < 10 kW EPBB ≥ 10 kW PBI < 10 kW PBI ≥ 10 kW 	<ul style="list-style-type: none"> Inland Coastal 	<ul style="list-style-type: none"> 2001-2003 2004-2006 2007-2009 2010-2012

Each combination of strata was classified as a “bin”, and all metered systems were assigned to one specific bin, e.g. “CSI/SCE/EPBB < 10 kW/Coastal/2007-2009”. The total installed capacity in each bin was then calculated. The actual production in kWh of all systems within each bin was then summed for the four 15-minute intervals comprising each hour—e.g. the four intervals beginning at 4 pm, 4:15 pm, 4:30 pm, and 4:45 pm on the peak day was summed for the hour beginning at 4 pm. This kWh sum for each bin during each hour was then divided by the total installed capacity of that bin to calculate the hourly capacity factor for each bin.

After developing representative hourly capacity factors for the bins, the capacity factors were multiplied by the total installations, both metered and non-metered, in each corresponding bin to calculate the total hourly generation from each bin. Finally, the total hourly generation was summed for all bins. The resulting total for the peak demand day is shown in Figure B-1 on the next page.

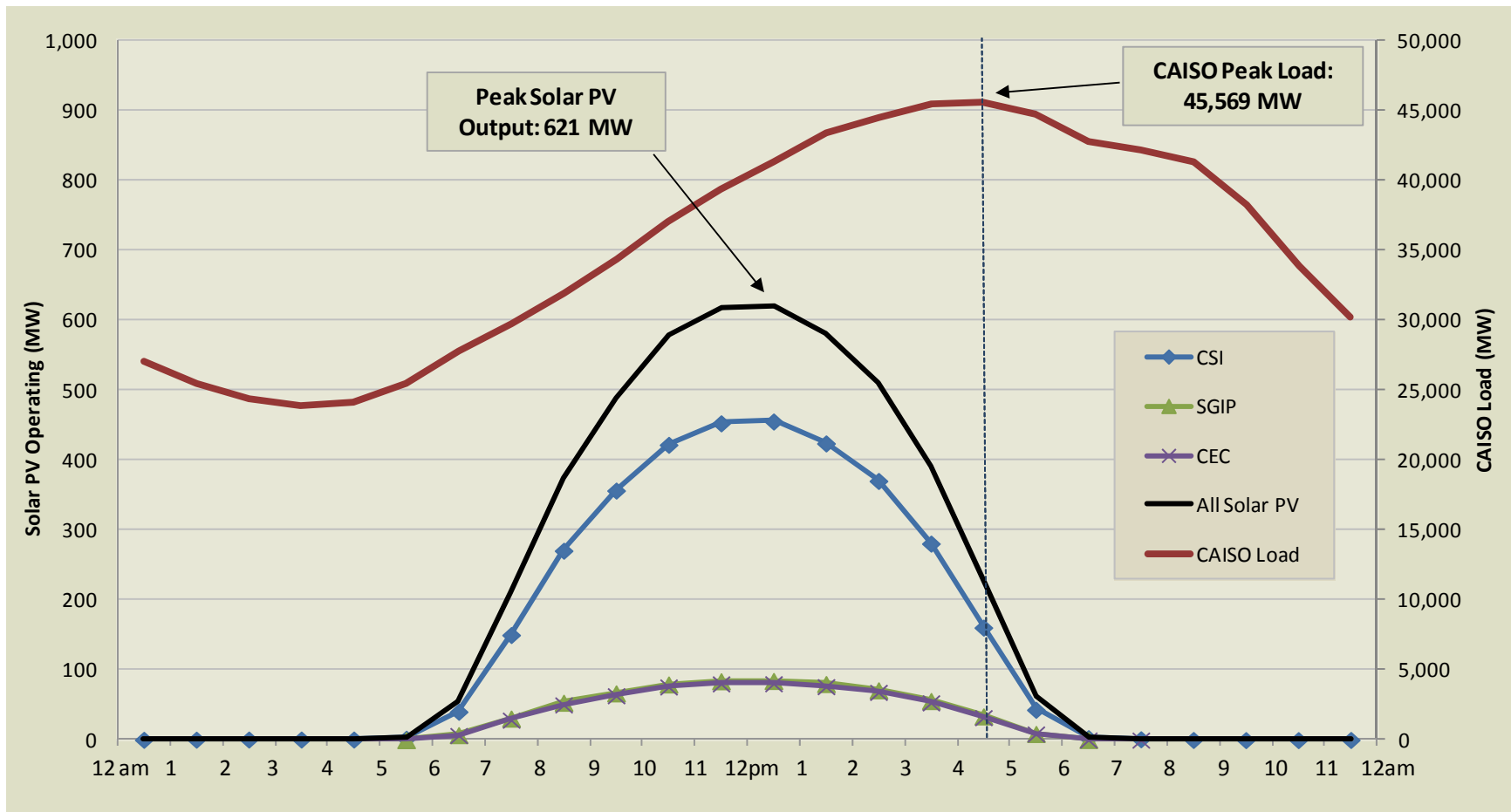

Figure B-1 DG Solar PV Operating and CAISO Load on September 7, 2011

The resulting peak hour capacity factors for each program and administrator are summarized in and Table B-4 below.

Table B-3 Peak Hour Capacity Factors for Solar PV by Program

PROGRAM	PEAK HOUR CAPACITY FACTOR
CSI – EPBB	0.26
CSI – PBI	0.26
SGIP	0.23
ERP	0.23
NSHP	0.26
All Programs	0.25

Table B-4 Peak Hour Capacity Factors for Solar PV by Program Administrator

PROGRAM	PEAK HOUR CAPACITY FACTOR
PG&E	0.28
SCE	0.23
SDG&E/CCSE	0.18
All Administrators	0.25

While this solar PV peak demand impact analysis replicates to a large extent the analysis conducted previously by Itron for the “CPUC California Solar Initiative 2010 Impact Evaluation Final Report”, Black & Veatch’s methodology is not identical.

Non-Solar PV Peak Demand Impact

For non-solar generation (fuel cells, microturbines, gas turbines, and internal combustion engines), the “CPUC Self-Generation Incentive Program Eleventh-Year Impact Evaluation” provide the peak day generation hourly capacity curves for these non-PV technologies. As shown in Figure B-2, the generation profile for these technologies are nearly flat throughout the day.

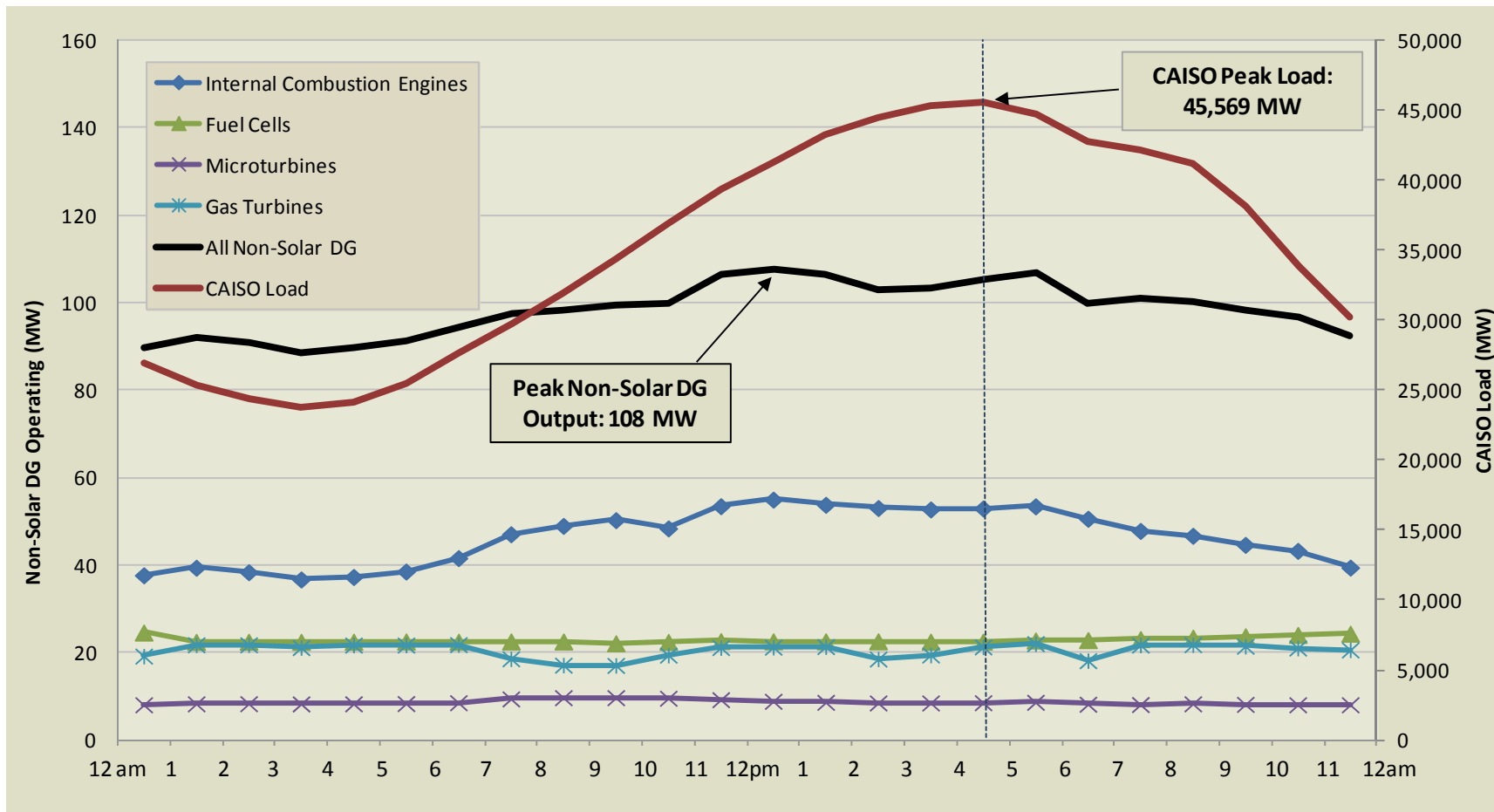

Figure B-2 Peak Day Generation Profiles for Non-PV Technologies

The peak demand capacity factors were also reported in the “CPUC Self-Generation Incentive Program Eleventh-Year Impact Evaluation” prepared by Itron in June 2012. These are shown below in Table B-5.

The total installed capacity in each of these technology categories was multiplied by the corresponding peak capacity factor to calculate the peak demand impact of each in MW. Since peak capacity factor data was not available for wind turbines and advanced energy storage systems, they were assigned a capacity factor of zero, i.e. they were assumed to have no impact on peak demand.

Table B-5 Peak Hour Capacity Factors for Non-PV Technologies

TECHNOLOGY	PEAK HOUR CAPACITY FACTOR
Wind Turbines	0.00
Renewable Fuels	
– Fuel Cells	0.84
– Micro-turbines	0.08
– Gas Turbines	0.00
– Internal Combustion Engines	0.49
Non-Renewable Fuels	
– Fuel Cells	0.54
– Micro-turbines	0.39
– Gas Turbines	0.83
– Internal Combustion Engines	0.32
Advanced Energy Storage	0.00

Appendix C. Future DG Study

There is much to be gained from a more detailed investigation of the current and future impacts and benefits of DG on the electric grid of the investor-owned utilities (IOUs) in California. Such an investigation would address the following questions:

- How is DG affecting the distribution and transmission system currently, and how will this change in the future?
- How much more DG could be deployed on the system if siting were optimized for minimal impacts and enhanced benefits?
- What additional tools are needed to identify optimal location, type, and timing of DG?
- How can an enhanced understanding of the costs of different impacts, benefits and solutions help inform effective policy to enable the deployment of more DG?
- How could the deployment of more DG be beneficial? If deployed ineffectively, how could it be deleterious?

Answering these questions can help create a clear roadmap of the growth potential of DG, and to enable California to anticipate potential challenges to DG deployment. A comprehensive study can help answer them, by summarizing the analysis that has been done to date, and analyzing the available data for existing systems, and forecasting impacts of future growth.

There are a number of projects and existing studies that have been performed that address the status, impacts and benefits of DG. There are several studies currently being performed with some notable efforts now underway listed below:

- CPUC CSI Research, Development, Demonstration, and Deployment Programs
- DOE's High Penetration Solar Deployment Projects
- CPUC Statewide Cost-Benefits Analysis of NEM (E3)
- CSI Market Transformation Study (Navigant)
- CPUC Renewable Distributed Generation Technical Analysis (Black & Veatch)
- San Diego NEM Study (Black & Veatch)

The analysis performed as part of the future DG study proposed should not duplicate analysis available from other studies, but leverage existing information and compile it in a useful format to answer the questions above. A new analysis should intelligently aggregate available information and provide a comprehensive review to extract meaningful trends that address open questions. This study will include five primary sections:

1. Existing Conditions
2. Impacts and Costs of DG
3. Potential Benefits of DG
4. Solutions
5. Scenario Analyses

The analysis should focus on the status, impacts, costs, and benefits of DG on the distribution system, rather than the transmission system, and it shall be a technical and quantitative analysis.

1) Existing Conditions Assessment

Tasks under this first section will consist largely a literature review of existing studies (including the reports listed above) and a quantitative assessment of the existing system to comprehensively document the current status of California's distribution system and DG in California.

- a. First, review the status of the distribution system in California; document the differences between utilities in California in terms of the vintage (new, old), operational characteristics (automated, manual, un-operated), and other relevant aspects of their distribution systems. Understand how each utility is dealing with DG and different approaches. Review and understand the testimony which resulted in the recent Rule 21 modifications.
- b. Secondly, study the trends in DG deployment to date. Generally, this study should answer the following questions: Where is DG being installed? What feeders currently have the highest penetration of DG, and what impacts are they seeing? Is the deployment of DG random in terms of location, or clustered in a way that can be predicted? Is clustering causing a negative impact that could prevent further DG from being deployed? More specifically, this study should assess trends based on system size categories, such as large (3-20 MW that are utility owned or owned by IPPs with contracts with utilities), medium (1-3 MW that are likely part of the feed in tariff programs), and small (0-1 MW which are generally residential or commercial installations under various incentive programs). Specific questions under each system size category should be answered:
 - a. Large:
 - How many of these DG projects are transmission grid connected and how many connect to distribution and where are they?
 - How many DG projects exceed the loads on the distribution lines they are connected to?
 - Are any of these large DG installations located on long rural distribution lines?
 - What additional upgrades have been required to accommodate these large DG projects?
 - Are there any examples where system upgrades have not been required?
 - Have utilities sited any of these large DG projects to maximize benefits?
 - What needs to be done to measure and understand the benefits and costs of large installations?
 - b. Medium:
 - How many of these DG projects exist and where are they?
 - What penetration level is achieved?

- Are there any examples where several medium size DG projects are located on one distribution line?
- To what extent have system upgrades been required for medium size systems or aggregations of medium size systems?
- Have utilities sited any of these medium size DG projects to maximize benefits?
- What needs to be done to measure and understand the benefits and costs of these installations?

c. Small:

- How many new solar home communities exist?
- What penetration levels exist on the distribution lines these communities connect to?
- Are there any locations where multiple high penetration solar home communities connect to one transmission line?
- When such new solar home communities are developed and implemented, are any special upgrades made to operate distribution system or to measure the impacts of the high solar DG penetration levels?
- What needs to be done to measure and understanding the benefits and costs of existing high penetration solar communities?

- c. Finally, include a study of the status of DG in other states and countries. How are others dealing with DG impacts? Likely candidates include Hawaii, Germany and Denmark.

This analysis should provide a useful definition of DG. Should DG include those systems of a certain size connected to the transmission system? Should the definition of DG be limited to systems, of any size, connected to the distribution system?

2) Impacts and Costs of DG

To date, impacts of DG on the distribution and transmission systems are not well understood. There is a tremendous amount of data available about DG systems throughout California, though the data is often out of date, of poor quality, or kept in obscure locations that limit access. Furthermore, there appears to be very limited data about the effect of DG on the utilities' distribution systems. Compiling this data and extracting meaningful trends would support our understanding of the current impacts of DG and their costs. The following datasets could be used:

- Customer-side DG systems receiving incentives:
 - CSI Working Data Set
 - SGIP dataset
 - ERP dataset
 - NSHP dataset

- IOU DG interconnection datasets and including any system upgrade costs identified in each application (including NEM and non-NEM installations)
- Wholesale DG systems under various state programs:
 - FIT – AB 1969
 - FIT – SB 32
 - RAM
 - Solar PV Programs
 - FIT – AB 1613
- IOU Wholesale Distribution Access Tariff (WDAT) interconnection queues
- CAISO interconnection queue

Understanding the impacts and costs of DG involves compiling the real-world data available from the sources listed above and others. In addition, available data on deployed energy storage systems should be collected, data gaps should be identified, and research strategies for filling those gaps should be created. From this data and other relevant data sources, a plot can then be created, similar to that shown in Figure C-1. Figure C-1 shows the hypothetical incremental cost of installing DG on a feeder over a range of penetration levels. This graph should be filtered for the appropriate attributes because each utility operates differently, feeder designs are highly variable and can be characterized by a number of factors (e.g. urban vs. rural), and because the size of a DG system has an effect on its impact to the distribution system. These attributes may include, but not be limited to the name of the utility, location of feeder, and size of DG system.

Figure C-1 also reflects the hypothetical level of effort needed to interconnect a given amount of DG. For example, at low penetration levels, no upgrades to the DG system may be needed; however, when penetration increases to a certain point, it could be that changes to system protection schemes or devices may be necessary.

The intent of this graph is to convey an understanding of what DG penetration levels cause impacts and require action. The different curves in this graph illuminate changes in DG integration costs, based on different system scenarios, and can be extrapolated to forecast impacts and costs of DG.

However, it should be stressed that the figure is hypothetical. It posits that costs increase as penetration on a feeder increases, and that different feeder types might have different, discernible relationships between costs and penetration. In fact, neither of these may be correct assumptions. Penetration level may not be a large driver in costs and impacts of DG. A key objective of this task will be to test these assumptions.

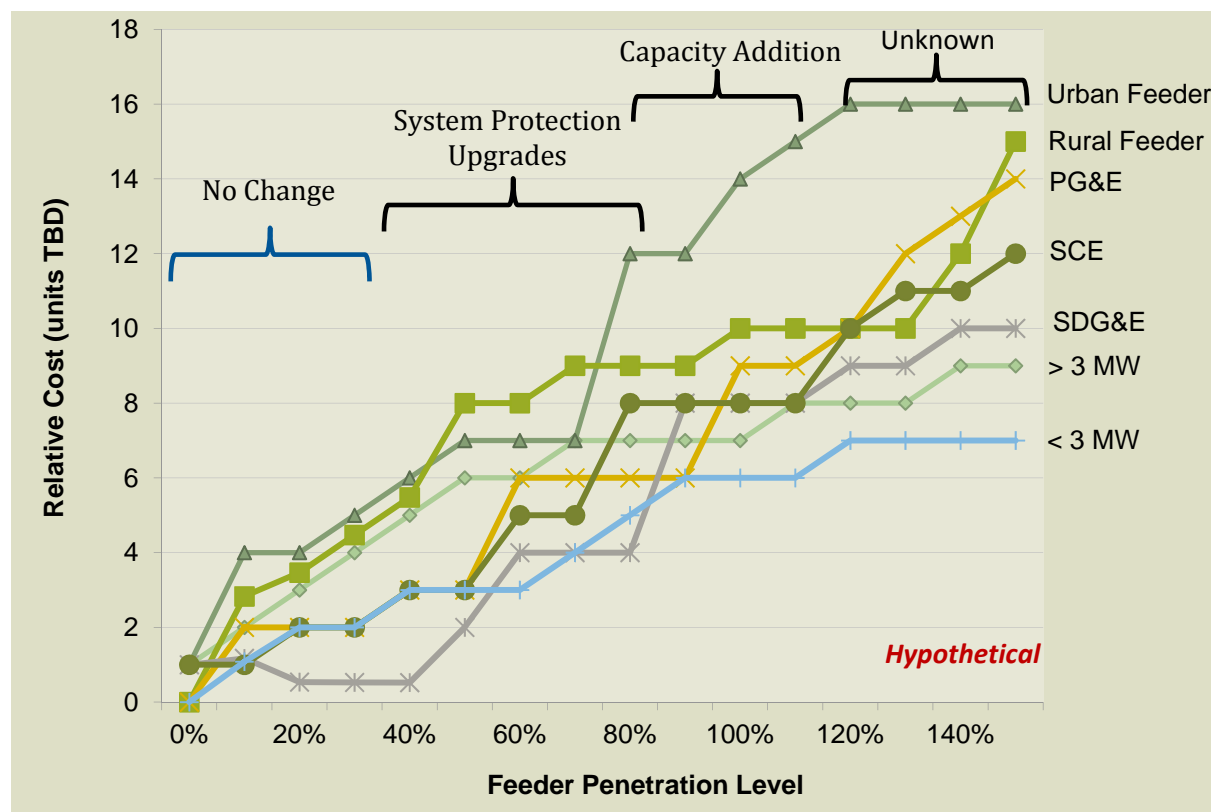

Figure C-1 Sample Graph Showing Interconnection Costs Relative to Penetration Level

3) Potential Benefits of DG

Many studies have suggested a wide variety of possible benefits associated with DG such as a reduction in peak demand; reduction in line losses; deferrals of distribution system upgrades; and increased reliability because of the presence of redundant energy sources. However, as shown in this study, very few of these benefits are currently being adequately quantified. In fact, some of the purported benefits may actually be manifested as costs. For example, rather than deferring distribution upgrades, utilities may be upgrading their distribution systems to accommodate DG. Finally, it is not known if the value or responsibility for these benefits or costs is being properly assigned to the impacted parties.

This task requires the quantification of the actual impacts of DG that are seen today on the distribution system. Many studies have been done on these issues in the past. However, these studies have generally relied on simulated scenarios or limited actual data from isolated circuits. The objective of this task would be to collect actual data from across California to validate whether the purported benefits are actually being achieved. Once the data on benefits is collected, it can be analyzed in a manner similar to the cost data. Trends could be plotted, and key variables might be identified which tend to drive the benefits of DG higher in certain scenarios.

The magnitude of demand reduction from DG would also be studied further as part of this task. How is demand affected during minimum load hours? What are the demand impact differences by utility?

Finally, this study should estimate how impacts will change as DG grows. Are certain regions receiving more benefits than others?

4) Solutions

This section should cover the following questions:

- How can negative impacts caused by DG be mitigated?
- How can the benefits of DG be enhanced?
- What measures can be taken to change the shape of the charts developed in the Impacts and Benefits tasks, and what do these measures cost?

Based on the analysis in the previous sections, discuss potential technical solutions or strategies that could be taken to mitigate impacts and enhance benefits. These may include:

- Optimally locating systems geographically to limit negative attributes of DG, and enhance positive attributes.
- Designing a “DG Ready” distribution system and quantifying associated costs
- Strategically locating energy storage throughout the grid
- Aligning incentives with the known benefits and impacts in different locations
- Smart Inverters and Smart Grid
- Electric vehicles
- Distribution system infrastructure equipment commonly used by other countries to support high penetration of DG.
- Create tools to allow planning and distribution engineer to mine data (including Smart Meter data) to facilitate a better understanding and identification of the costs and benefits of DG systems.

Many of the solutions identified may require revision of design standards used by utilities. Of the solutions identified, estimate the costs and benefits of to implementing these solutions.

5) Scenario Analysis

To understand the quantitative impacts of various DG penetration levels, and solutions, a scenario analysis shall be performed. This will entail modeling parts of the distribution system and showing the effects on the curves proposed for the Impacts and Benefits sections.

- Study different penetration levels of DG: 0, 10, 15, 50, 75, 100, 150 and 200 percent
- Study how siting DG systems differently impacts the system on various categories of distribution feeders, such as rural and urban.
- Model and study the impacts and benefits of different DG technologies that have seen significant deployment on the grid to date which are:

- Solar PV
- Wind turbines
- Fuel cells (with either renewable or non-renewable fuels)
- Gas turbines (with either renewable or non-renewable fuels)
- Microturbines (with either renewable or non-renewable fuels)
- Internal combustion engines (with either renewable or non-renewable fuels)
- Model and study the effect on the Impacts and Benefits graphs when the solutions identified in the above task are implemented.

The goal of this scenario analysis will be to describe a likely range of DG penetration scenarios on distribution systems in California, and the costs and benefits associated with each, to help inform future DG policy in the state.

Appendix D. January 31, 2013 Report Presentation, Including Selected 2012 Data Updates